



The Future of Analog IC Technology®

EVHF500-30-P-00A

HF500-30 Full Featured Flyback Regulator Evaluataion Board with Universal Input, 12V/2.5A Output

DESCRIPTION

The HF500-30 is a fixed-frequency, current-mode regulator with built-in slope compensation. It combines a 700V MOSFET and a full-featured controller into one chip for a low-power, offline, flyback, switch-mode power supply.

At medium and heavy loads, the regulator works in a fixed frequency with frequency jittering. Jittering helps reduce the EMI energy on switching frequency and its harmonics. During a light-load condition, the regulator freezes the peak current and reduces its switching frequency to $f_{OSC(min)}$ to offer excellent efficiency. At very light load, the regulator enters burst mode to achieve low standby power consumption.

HF500-30 is equipped with full protection features, include: brown-in and brownout, VCC under-voltage lockout (UVLO), overload protection (OLP), short-circuit protection (SCP), input over voltage protection, VCC over-voltage protection (OVP), and over-temperature protection (OTP).

The HF500-30 features over-power line compensation to ensure that the overload protection point is independent of the input voltage.

The HF500-30 is available in a PDIP8-7B package.

ELECTRICAL SPECIFICATION

Parameter	Symbol	Value	Units
Input Voltage	V_{IN}	85 to 265	VAC
Output Voltage	V_{OUT}	12	V
Output Current	I_{OUT}	2.5	A
Output Power	P_{OUT}	30	W

FEATURES

- 700V/1.4Ω Integrated MOSFET
- Fixed-Frequency Current-Mode-Control Operation with Built-In Slope Compensation
- Frequency Foldback Down to $f_{OSC(min)}$ at Light Load
- Burst Mode for Low Standby Power Consumption
- Frequency Jittering for a Reduced EMI Signature
- Over-Power Compensation
- Internal High-Voltage Current Source
- VCC Under-Voltage Lockout (UVLO) with Hysteresis
- Programmable Input B/O and OVP
- VCC Over Voltage Protection (OVP)
- Overload Protection (OLP) with a Programmable Delay
- Latch-Off Protection on TIMER
- Over-Temperature Protection (Auto-Restart with Hysteresis)
- Short-Circuit Protection (SCP)
- Programmable Soft Start

APPLICATIONS

- Power Supplies for Home Appliances
- Set-Top Boxes
- Standby and Auxiliary Power
- Adapters

All MPS parts are lead-free, halogen-free, and adhere to the RoHS directive. For MPS green status, please visit MPS website under Quality Assurance. "MPS" and "The Future of Analog IC Technology", are Registered Trademarks of Monolithic Power Systems, Inc.



Warning: Although this board is designed to satisfy safety requirements, the engineering prototype has not been agency approved. Therefore, all testing should be performed using an isolation transformer to provide the AC input to the prototype board.

EVHF500-30-P-00A EVALUATION BOARD

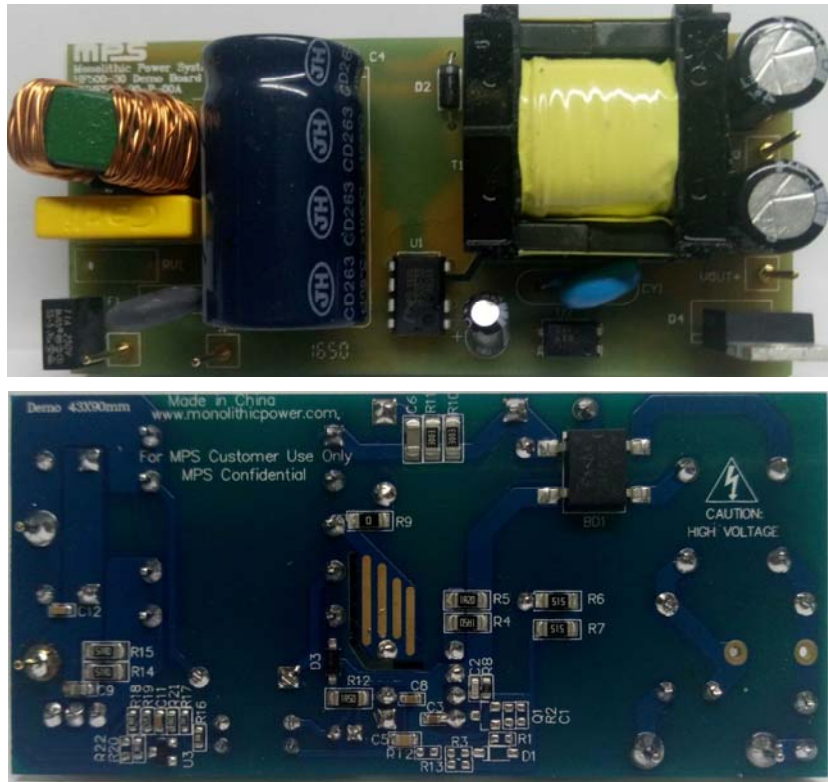

(L x W x H) 91mm x 43mm x 25mm

Board Number	MPS IC Number
EVHF500-30-P-00A	HF500GP-30

EVALUATION BOARD SCHEMATIC

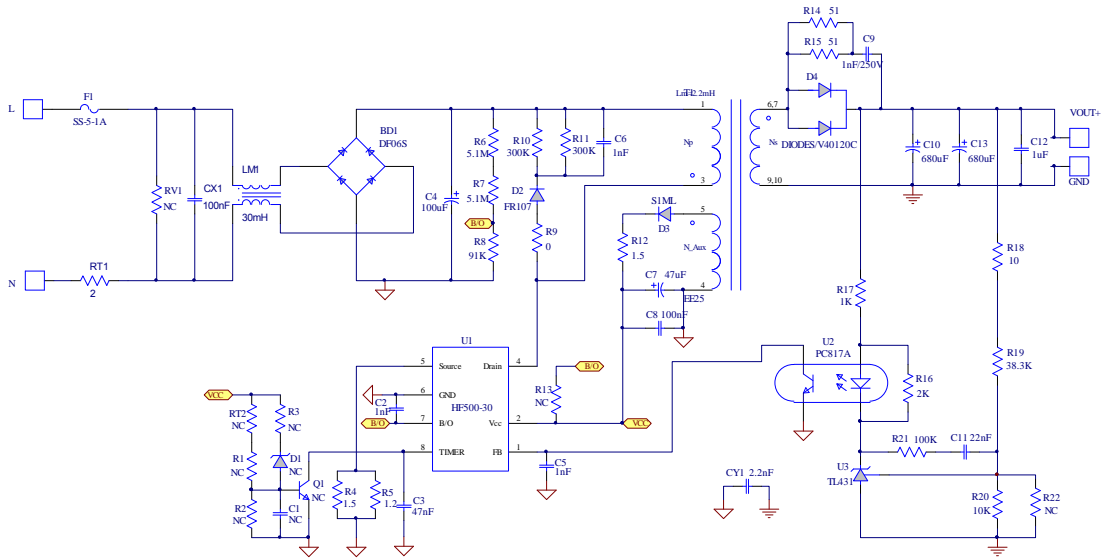

Figure 1—Schematic

PCB LAYOUT (SINGLE-SIDED)

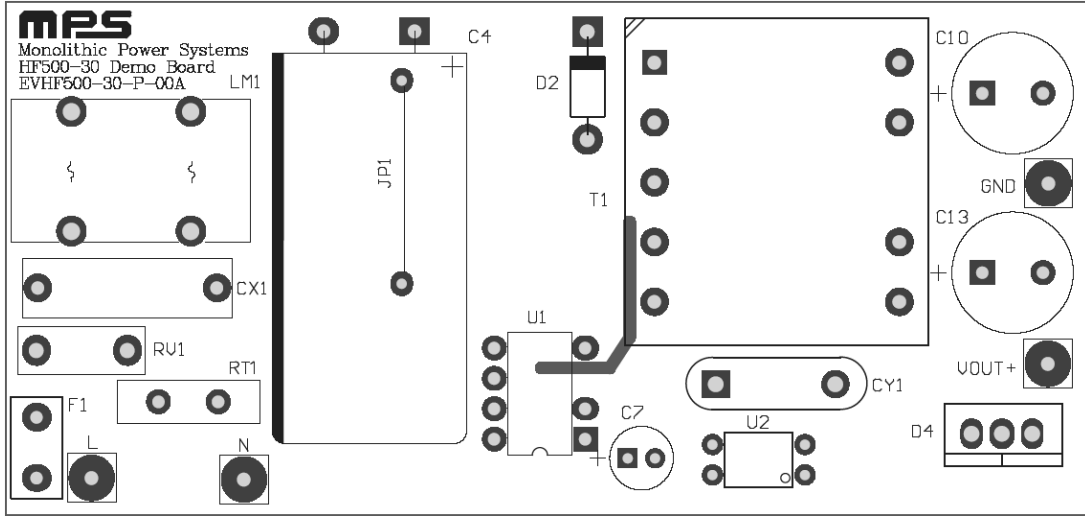

Figure 2—Top Layer and Silk

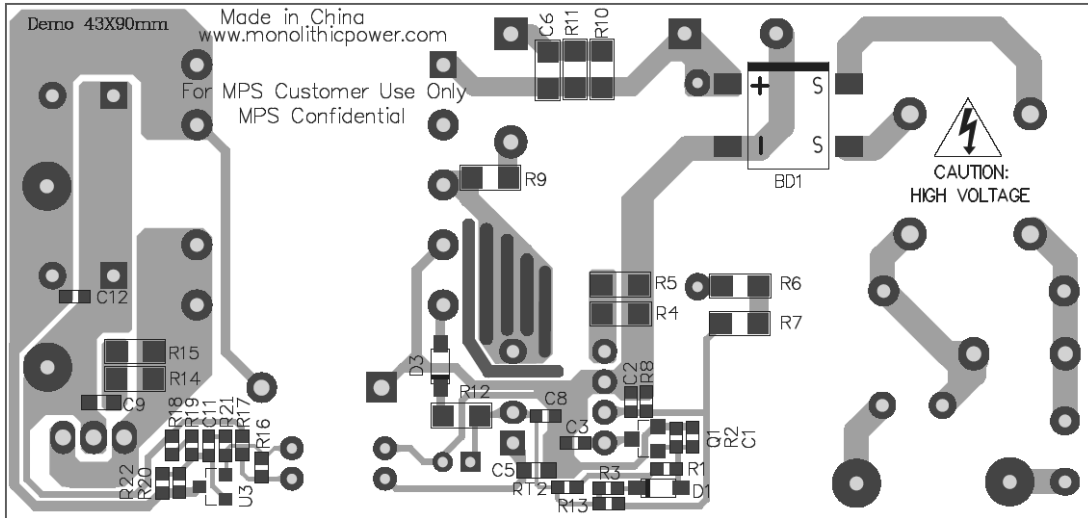

Figure 3—Bottom Layer and Silk

CIRCUIT DESCRIPTION

The EVHF500-30-P-00A is configured in a 12V/2.5A flyback application for HF500-30. It uses secondary-side-control to achieve precise voltage output.

F1 is a fuse which used to protect circuit from component failure or some excessive short events.

RT1 is an NTC resistor which restricts the inrush current when power on.

CX1 and LM1 are the input filters to guarantee the conducted EMI meet EN55022 standard. CY1 also helps with conducted EMI suppression.

C4 is the input bulk capacitor.

R10, R11, C6, and D2 compose primary side snubber. It absorbs the leakage inductance energy when MOSFET turns off, so that to restrain the high spike.

R6, R7 and R8 compose the resistor divider that connected to B/O for input brown in, brown out and OVP. If don't need B/O function, connect B/O and VCC with one large resistor (to keep B/O > 6V under normal operation) and remove the resistor divider.

D4 is output diode. Schottky diodes are recommended for their fast switching speed and low forward-voltage drop for better efficiency.

R14, R15 and C9 compose the secondary side snubber. It restrains the high spike of D4.

U2, U3 and the component around them are the feedback circuit. C11 and R21 are used as compensation network.

T1 is power transformer. It should be designed properly to satisfy the power delivery and achieve good EMI.

C10 and C13 are output capacitors. They should be low ESR electrolytic capacitor for better output ripple and even better efficiency. C12 is the small ceramic capacitor that bypasses the high frequency noise on output.

EVHF500-30-P-00A BILL OF MATERIALS

Qty	Ref	Value	Description	Package	Manufacturer	Manufacturer_P/N
1	BD1	DF06S	Bridge Rectifier; 400V; 1A	SMD	Fairchild	DF06S
0	C1	NC				
1	C2	1nF	Ceramic Capacitor; 50V; X7R	0603	muRata	GRM188R71H102KA01D
1	C3	47nF	Ceramic Capacitor; 50V; X7R	0603	muRata	GRM188R71H473KA61D
1	C4	100uF	Electrolytic Capacitor; 400V	DIP	Jianghai	CD263-400V100
1	C5	1nF	Ceramic Capacitor; 50V; X7R	0805	TDK	C2012X7R1H102K
1	C6	1nF	Ceramic Capacitor; 630V; U2J	1206	muRata	GRM31A7U2J102JW31D
1	C7	47uF	Electrolytic Capacitor; 25V	DIP	Jianghai	CD286-25V47
1	C8	100nF	Ceramic Capacitor; 50V; X7R	0603	muRata	GRM188R71H104KA93D
1	C9	1nF	Ceramic Capacitor; 250V; U2J	0805	muRata	GRM21A7U2E102JW31D
2	C10,C13	680uF	Electrolytic Capacitor; 25V	DIP	Rubycon	25ZLH680MEFC10*16
1	C11	22nF	Ceramic Capacitor; 50V; X7R	0603	muRata	GRM188R71H223KA01D
1	C12	1uF	Ceramic Capacitor; 25V; X5R	0603	TDK	C1608X7R1E105K
1	CX1	100nF	X2 Capacitor; 275VAC	DIP	Carli	PX104K3ID19L270D9R
1	CY1	2.2nF	Y1 Capacitor; 250VAC	DIP	Hongke	JNK12E222ML02N
0	D1	NC				
1	D2	FR107	Diode;1000V; 1A	DO-41	Diodes	FR107
1	D3	S1ML	Diode;1000V; 1A	SOD-123	Taiwan semiconductor	S1ML
1	D4	V40120C	Diode; 120V; 40A	TO220AB	Any	V40120C
1	F1	SS-5-1A	Fuse;250V; 1A	DIP	COOPER	SS-5-1A
1	LM1	30mH	Common Chock; 0.4Ohm	DIP	Emei	TP4M30-02
0	Q1	NC				
0	R1, R2, R3, R13, R22, RT2	NC				
2	R4, R12	1.5	Film Resistor; 1%	1206	Yageo	RC1206FR-071R5L
1	R5	1.2	Film Resistor; 1%	1206	Yageo	RC1206FR-071R2L
2	R6, R7	5.1M	Film Resistor; 5%	1206	Yageo	RI1206L515JT
1	R8	91K	Film Resistor; 1%	0603	Yageo	RC0603FR-0791KL
1	R9	0	Film Resistor; 5%	1206	Yageo	RC1206JR-070RL
2	R10,R11	300K	Film Resistor; 1%	1206	Yageo	RC1206FR-07300KL
2	R14,R15	51	Film Resistor; 5%	1206	Yageo	RC1206JR-0751R
1	R16	2K	Film Resistor; 5%	0603	LIZ	CR1603JA0202G
1	R17	1K	Film Resistor; 1%	0603	Yageo	RC0603FR-071KL
1	R15	100K	Film Resistor; 1%	0603	Yageo	RC0603FR-07100KL
1	R18	10	Film Resistor; 1%	0603	Yageo	RC0603FR-0710RL
1	R19	38.3K	Film Resistor; 1%	0603	Yageo	RC0603FR-0738K3L

**EVHF500-30-P-00A BILL OF MATERIALS (continued)**

Qty	Ref	Value	Description	Package	Manufacturer	Manufacturer_P/N
1	R20	10K	Film Resistor; 1%	0603	Yageo	RC0603FR-0710KL
1	R21	100K	Film Resistor; 1%	0603	Yageo	RC0603FR-07100KL
0	RV1	NC		DIP		
1	RT1	2	NTC	DIP	Jiangsuxingshun	2D2-10
1	T1	2.2mH	Transformer	EF25	Emei	FX0469 (1)
1	U1	HF500-30	Flyback Regulator	PDIP8-7B	MPS	HF500GP-30
1	U2	PC817A	optocoupler	DIP	Taiwanyiguang	PC817A
1	U3	CJ431	Shunt reference; 2.5V	SOT23	Changdian	CJ431
1	JP1	Jumper	17mm			
Notes:		(1) Emei transformer sample request please log on website: www.emeigroup.com				

TRANSFORMER SPECIFICATION

Basic Characteristics

Parameter	Value
Core	EF25
Bobbin	EF25 Horizontal, 5+5 Pin
Primary Inductance	2.2mH
Core Material	PC40 or equivalent
Turn Ratio	$N_P:N_S:N_{P_AUX}=150:16:22$

Electrical Diagram

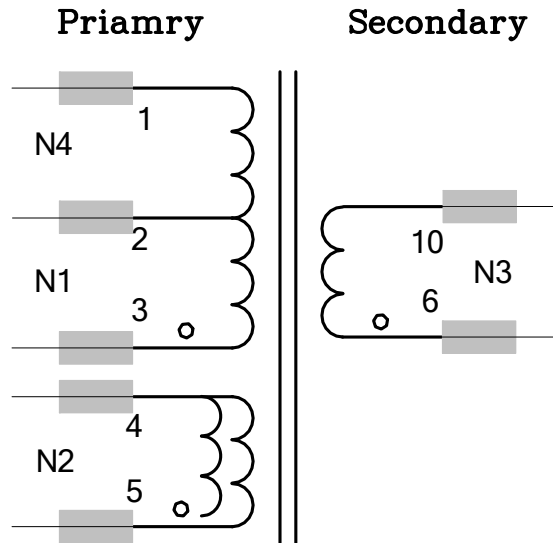

Figure 4—Transformer Electrical Diagram

Winding Diagram

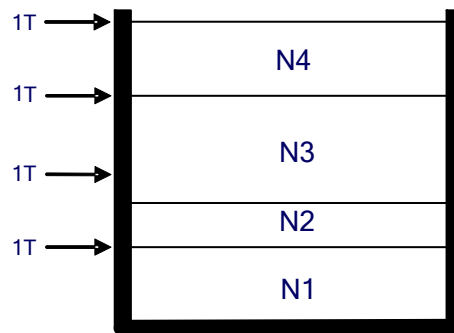

Figure 5—Winding Diagram

Winding Order

Tapes (T)	Winding	Start-End	Wire Diameter (Ø)	Turns (T)
0	N1	3→2	0.33*1	78
1	N2	5/NC→4	0.15*2	22
1	N3	6→10	0.6*2 TIW	16
1	N4	2→1	0.33*1	72

Electrical Specifications

Electrical Strength	60 seconds 60Hz, from PRI. to SEC.	3500VAC
	60 seconds 60Hz, from PRI. to CORE	1500VAC
	60 seconds 60Hz, from SEC. to CORE.	1500VAC
	60 seconds 60Hz, from N1 to N2.	500VAC
Primary Inductance	Pins 3 - 1, all other windings open, measured at 60kHz, 0.1 VRMS	2.2mH±10%

EVB TEST RESULTS

$V_{IN} = 230V_{AC}$, $V_{OUT} = 12V$, $I_{OUT} = 2.5A$, $T_A = 25^{\circ}C$, unless otherwise noted.

No Load Consumption

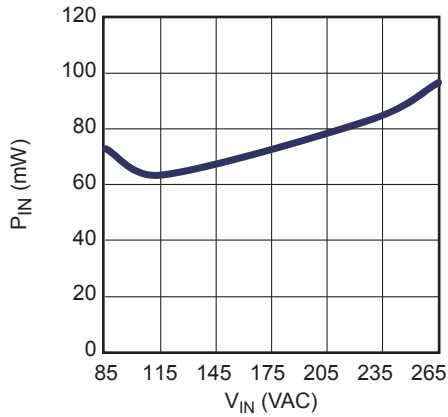

Efficiency

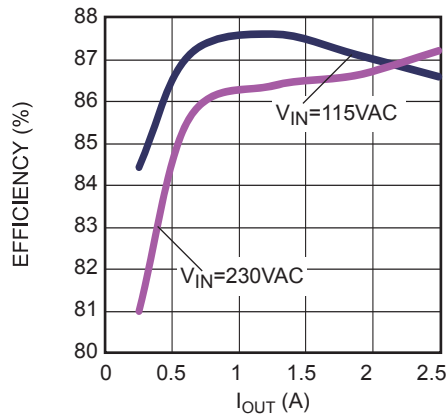

Conducted EMI
Line wire

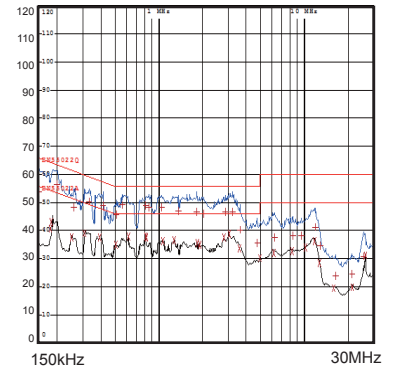

Conducted EMI
Neutral wire

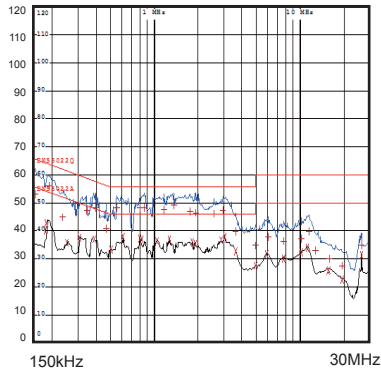

Thermal Performance
 $V_{IN}=85V_{AC}$

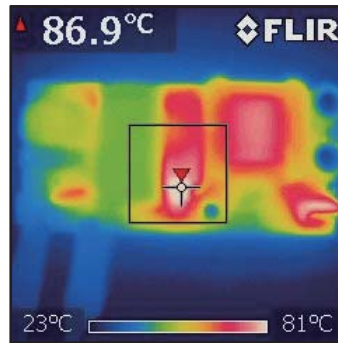

Thermal Performance
 $V_{IN}=265V_{AC}$

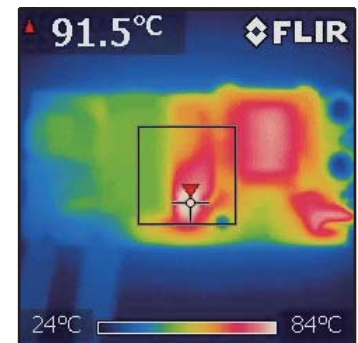

EVB TEST RESULTS (continued)

$V_{IN} = 230V_{AC}$, $V_{OUT} = 5V$, $I_{OUT} = 2A$, $T_A = 25^{\circ}C$, unless otherwise noted.

Input Power On

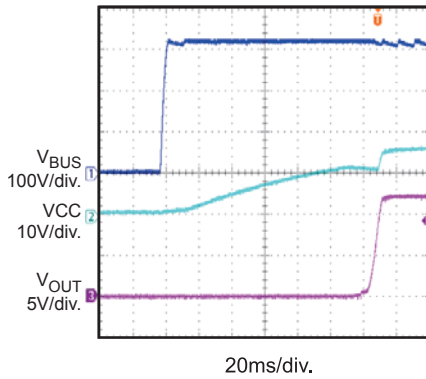

Input Power Off

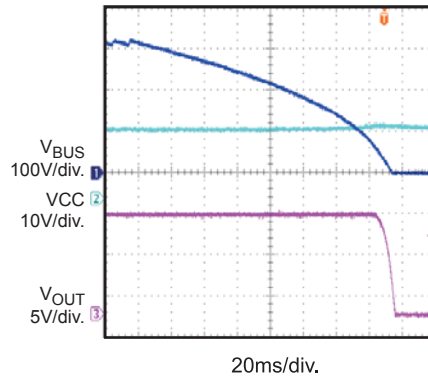

Stress

$V_{IN} = 265V_{AC}$

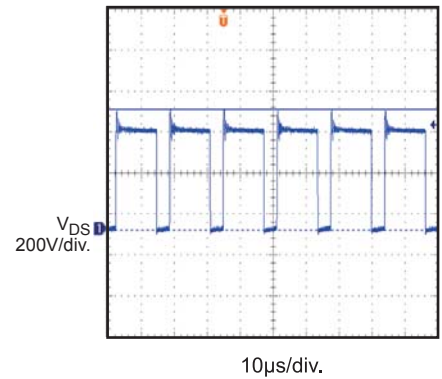

Output Ripple

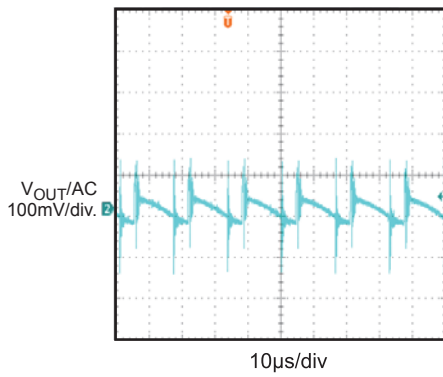

OLP Entry

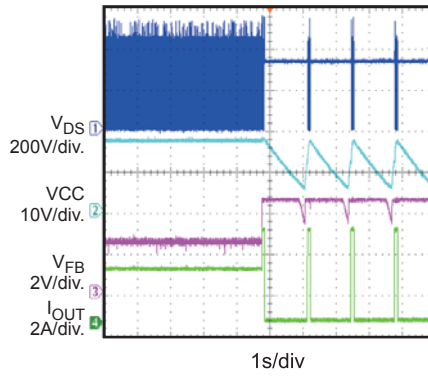

OVP Entry

No Load

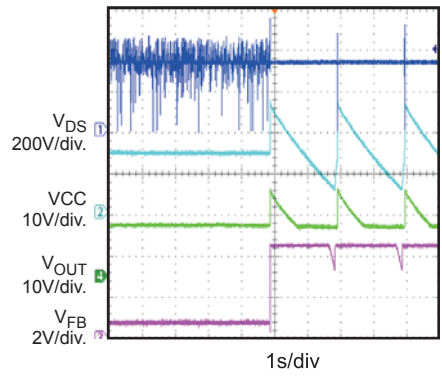

Brown-in

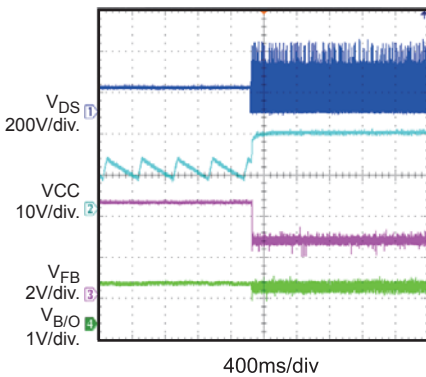

Brownout

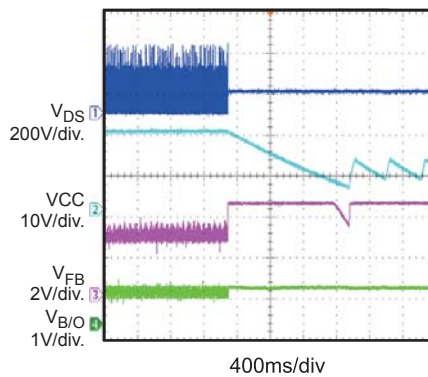

OTP Entry

$V_{IN} = 115V_{AC}$, No Load

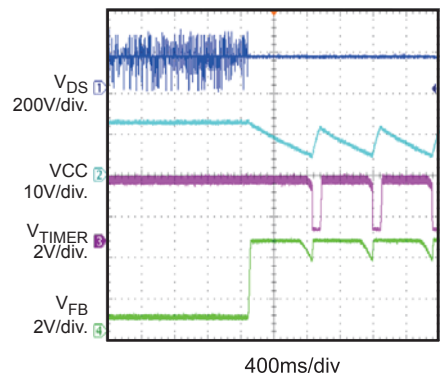

QUICK START GUIDE

1. Preset Power Supply to $85\text{VAC} \leq V_{\text{IN}} \leq 265\text{VAC}$.
2. Turn Power Supply off.
3. Connect the Line and Neutral terminals of the power supply output to L and N port.
4. Connect load + and – ports to VOUT and GND.
5. Turn Power Supply on after making connections.

NOTICE: The information in this document is subject to change without notice. Users should warrant and guarantee that third party Intellectual Property rights are not infringed upon when integrating MPS products into any application. MPS will not assume any legal responsibility for any said applications.