

DESCRIPTION

The EV9928-F-00B Evaluation Board is designed to demonstrate the capabilities of MP9928. The MP9928 is a high-voltage, synchronous step-down controller that directly steps down voltages from up to 60V. The MP9928 uses PWM current control architecture with accurate cycle-by-cycle current limiting and is capable of driving dual N-channel MOSFETs.

The operating frequency of the MP9928 can be programmed by an external resistor or synchronized to an external clock for noise sensitive applications. Full protection features include precision output over-voltage protection (OVP), output over-current protection (OCP), and thermal shutdown.

The MP9928 is available in TSSOP20-EP and QFN-20 (3mmx4mm) packages. This board is available in TSSOP20-EP package.

ELECTRICAL SPECIFICATION

Parameter	Symbol	Value	Units
Input Voltage	V_{IN}	6-60 ⁽¹⁾	V
Output Voltage	V_{OUT}	5	V
Output Current	I_{OUT}	7	A

FEATURES

- 6V to 60V Input Voltage for This 5V Output Board
- Dual N-Channel MOSFET Driver
- Low Dropout Operation: Maximum Duty Cycle at 99.5%
- 180° Out-of-Phase SYNCO Output
- Programmable Soft Start
- Output Power Good Indicator
- Selectable Threshold for Cycle-by-Cycle Current Limit
- Programmable Frequency Range: 100kHz-1000kHz
- External Power Bias Option for Vcc Supply
- Output Over-Voltage Protection (OVP)
- Over-Current Protection (OCP)
- TSSOP20-EP Package on This Board

APPLICATIONS

- PD Power Supply in PoE System
- USB Dedicated Charging Port (DCP)
- Industrial Control Systems
- Power Supply for Linear Chargers

All MPS parts are lead-free, halogen free, and adhere to the RoHS directive. For MPS green status, please visit MPS website under Quality Assurance.

“MPS” and “The Future of Analog IC Technology” are Registered Trademarks of Monolithic Power Systems, Inc.

Note: (1) The IC can work to 4V input, but the output voltage will drop, it is limited by the maximum duty cycle.

EV9928-F-00B EVALUATION BOARD



(L x W x H) 8.36cm x 8.36cm x 0.8cm
(Four Layers)

Board Number	MPS IC Number
EV9928-F-00B	MP9928GF

Efficiency

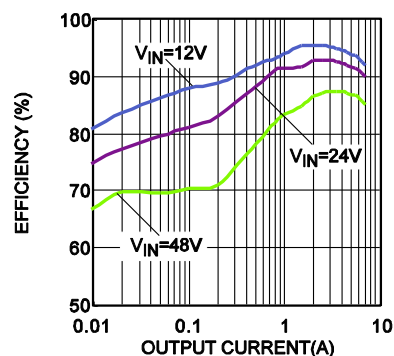

EVALUATION BOARD SCHEMATIC

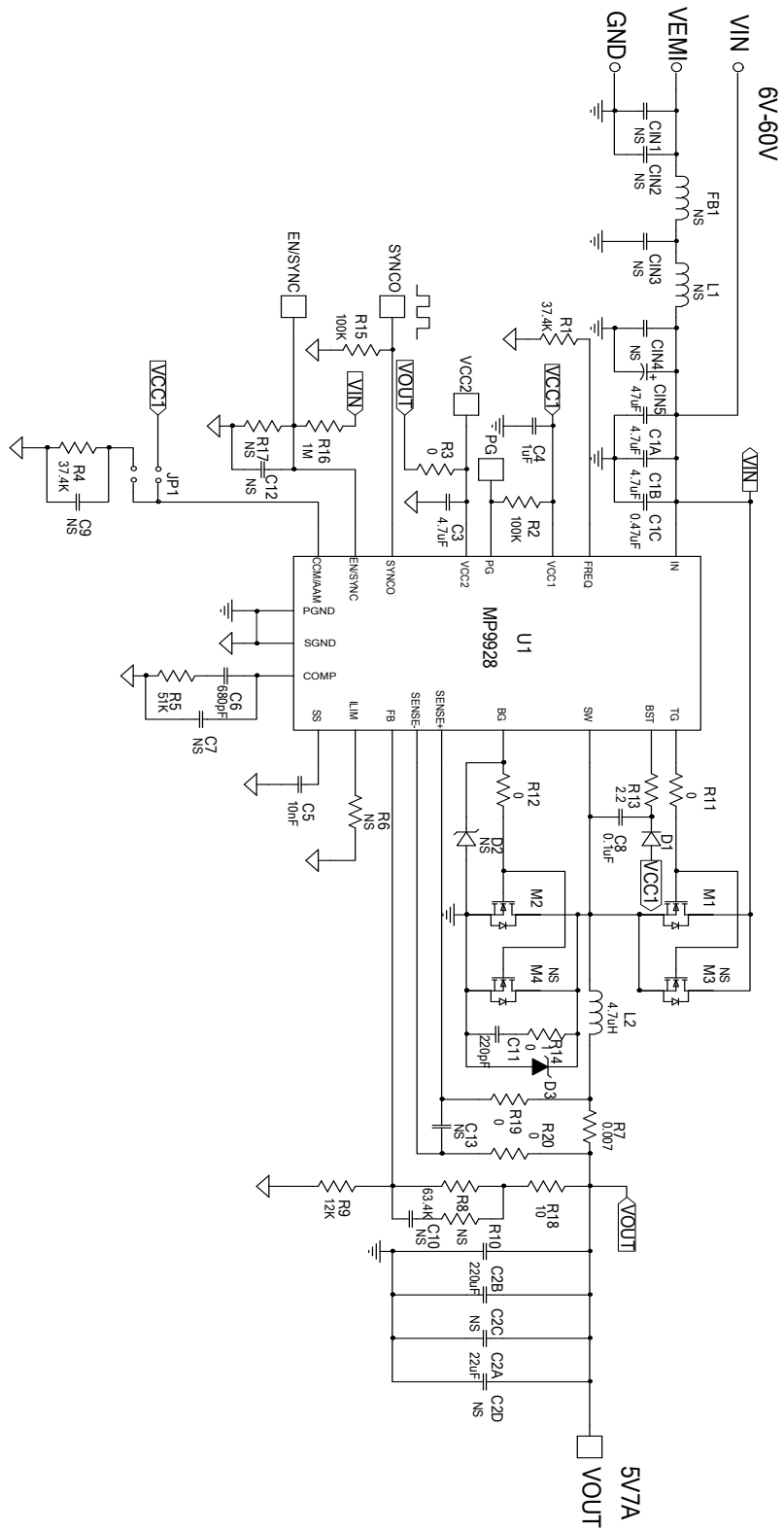

EV9928-F-00B BILL OF MATERIALS

Qty	Ref	Value	Description	Package	Manufacturer	Part Number
0	CIN1, CIN2, CIN3, CIN4	NS				
1	CIN5	47 μ F	Electrolytic Cap;100V; 10*10.5;2000H;105°C	SMD	Jiang Hai	VZ2-100V47
2	C1A,C1B	4.7 μ F	Ceramic Cap;100V;X7S	1210	TDK	C3225X7S2A475K
1	C1C	0.47 μ F	Ceramic Cap;100V;X7R	0805	muRata	GRM21BR72A474KA73L
1	C2B	220 μ F	POSCAP;6.3V;	D2	SANYO	6TPE220MI
1	C2A	22 μ F	Ceramic Cap;16V;X7R	1210	muRata	GRM32ER71C226KE79
0	C2C,C2D	NS				
1	C3	4.7 μ F	Ceramic Cap;16V;X7R	0805	muRata	GRM21BR71C475KA73L
1	C4	1 μ F	Ceramic Cap;16V;X7R	0603	muRata	GRM188R71C105KA12D
1	C5	10nF	Ceramic Cap;50V;X7R	0603	muRata	GRM188R71H103KA01
1	C6	680pF	Ceramic Cap;50V;X7R	0603	muRata	GRM188R71H681KA01D
0	C7,C9, C10,C12, C13	NS				
1	C8	0.1 μ F	Ceramic Cap;16V;X7R	0603	muRata	GRM188R71C104KA01D
1	C11	220pF	CeramicCap;100V;X7R	0603	muRata	GRM21BR72A221KA01L
1	D1	1N4148WS	Diode;75V;0.15A;	SOD-323	Diodes	1N4148WS-7-F
0	D2	NS				
1	D3	DFLS1150	Diode;150V;1A;		Diodes	DFLS1150
0	FB1	NS				
0	L1	NS				
1	L2	4.7 μ H	Inductor;4.7 μ H; 7.7mOhm;15A	SMD	Wurth	7443551470
2	M1, M2	SQJ850EP	N-Channel MOSFET; 60V;24A;0.023Ohm	PowerPAK SO-8L	Vishay	SQJ850EP
0	M3, M4	NS				
2	R1, R4	37.4k	Film Resistor;1%	0603	ROYAL	RC0603FR-0737K4L
2	R2, R15	100k	Film Resistor;1%	0603	ROYAL	RC0603FR-07100KL
5	R3, R11,R12, R19,R20	0	Film Resistor;5%	0603	ROYAL	RC0603JR-070RL
1	R5	51k	Film Resistor;1%	0603	ROYAL	RC0603FR-0751KL
0	R6,R10 R17	NS				

EV9928-F-00B BILL OF MATERIALS *(continued)*

Qty	Ref	Value	Description	Package	Manufacturer	Part Number
1	R7	0.007	Film Resistor;1%;1W	2512	CYNTEC	RL3264-6-R007-FN
1	R8	63.4k	Film Resistor;1%	0603	ROYAL	RC0603FR-0763K4L
1	R9	12k	Film Resistor;1%	0603	ROYAL	RC0603FR-0712KL
1	R13	2.2	Film Resistor;1%	0603	ROYAL	RC0603FR-072R2L
1	R14	10	Film Resistor;1%	0805	ROYAL	RC0805JR-0710RL
1	R16	1M	Film Resistor;1%	0603	ROYAL	RC0603FR-071ML
1	R18	10	Film Resistor;1%	0603	ROYAL	RC0603FR-0710RL
1	U1	MP9928GF	Synchronous Step-Down Controller	TSSOP20-EP	MPS	MP9928GF

EVB TEST RESULTS

$V_{IN} = 24V$, $V_{OUT} = 5V$, $L = 4.7\mu H$, $T_A = 25^\circ C$, unless otherwise noted.

Efficiency

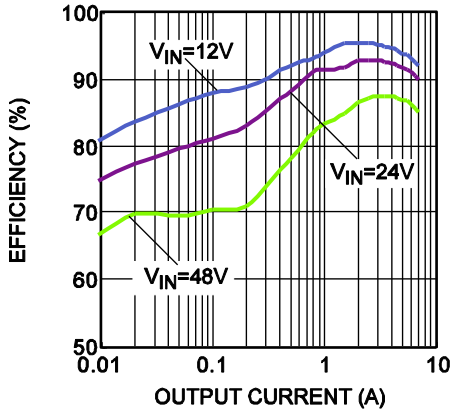

Load Regulation

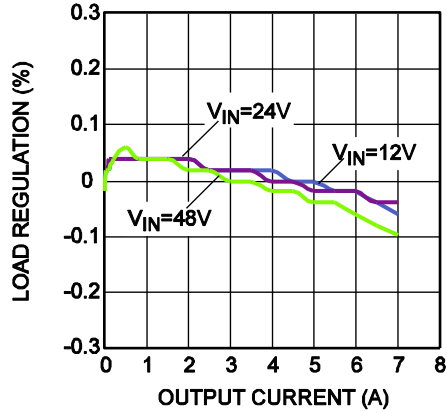

Line Regulation

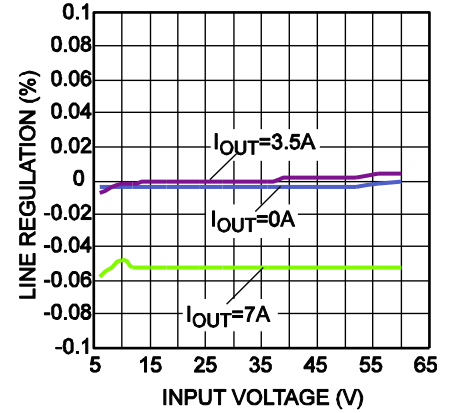

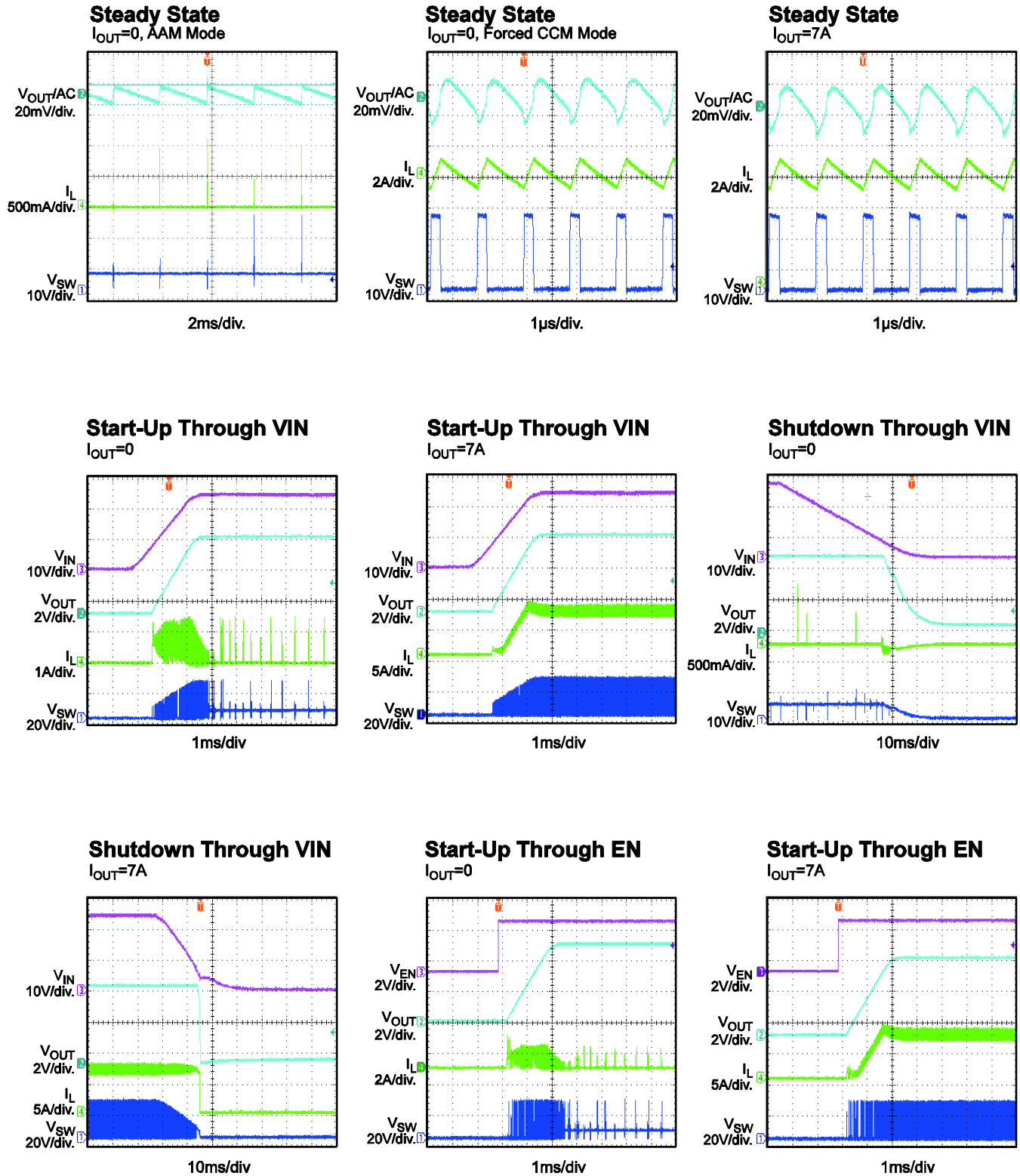
EVB TEST RESULTS (continued)
 $V_{IN} = 24V$, $V_{OUT} = 5V$, $L = 4.7\mu H$, $T_A = 25^\circ C$, unless otherwise noted.

EVB TEST RESULTS (continued)
 $V_{IN} = 24V$, $V_{OUT} = 5V$, $L = 4.7\mu H$, $T_A = 25^\circ C$, unless otherwise noted.

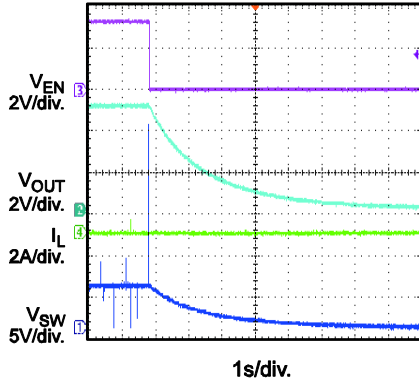
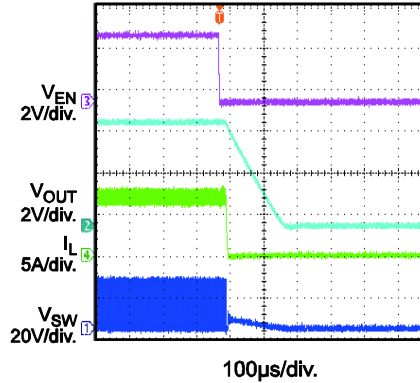
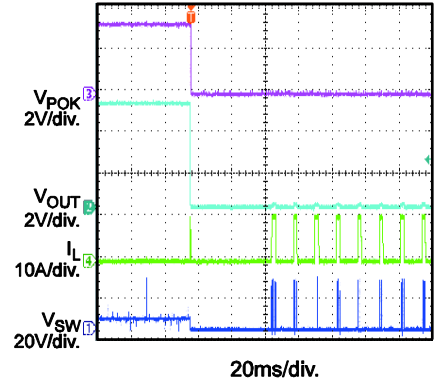
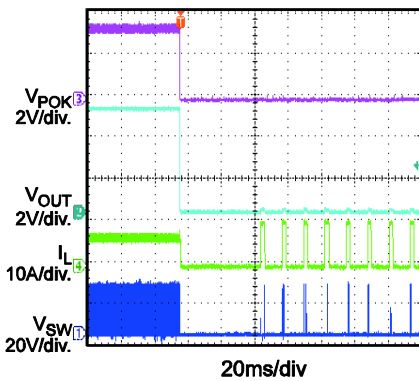
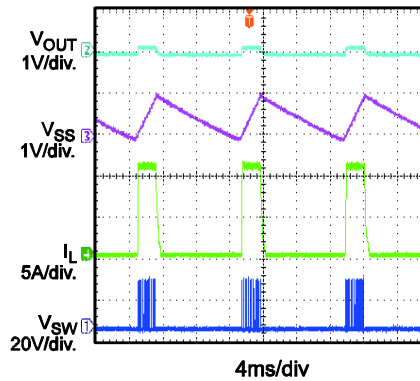
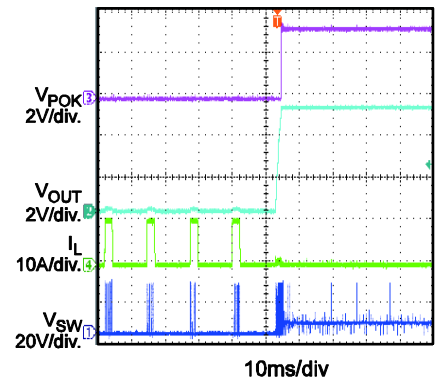
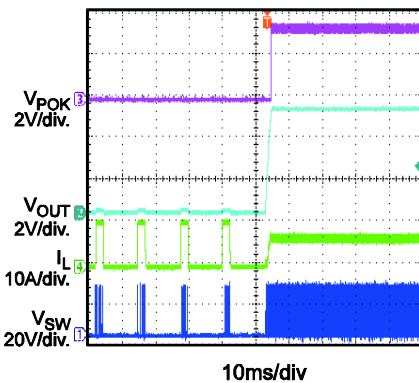
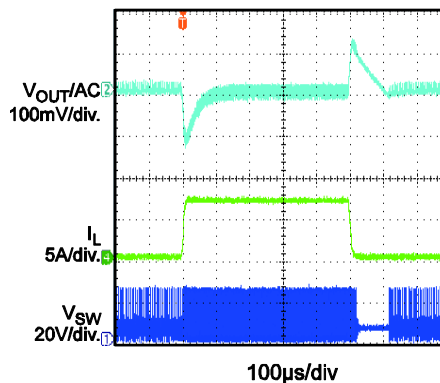
Shutdown Through EN
 $I_{OUT} = 0$

Shutdown Through EN
 $I_{OUT} = 7A$

SCP Entry
 $I_{OUT} = 0$ to short circuit

SCP Entry
 $I_{OUT} = 7A$ to short circuit

SCP Steady State

SCP Recovery
 short circuit to $I_{OUT} = 0$

SCP Recovery
 short circuit to $I_{OUT} = 7A$

Load Transient
 $I_{OUT} = 0.2A \leftrightarrow 7A$, $1.6A/\mu s$

PRINTED CIRCUIT BOARD LAYOUT

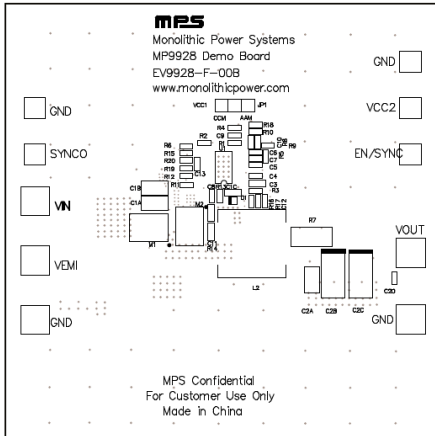

Figure 1—Top Silk Layer

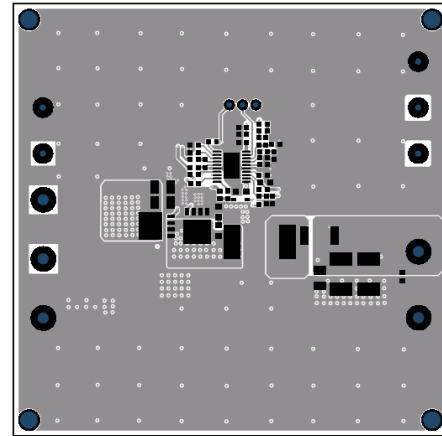

Figure 2—Top Layer

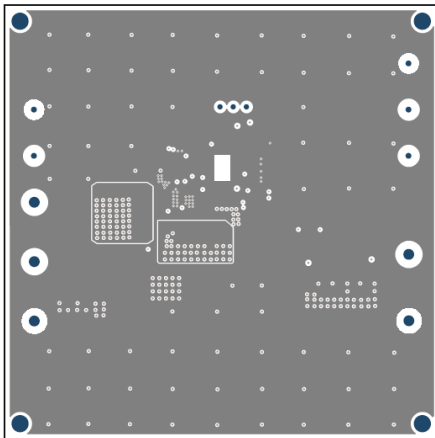

Figure 3—Middle Layer 1

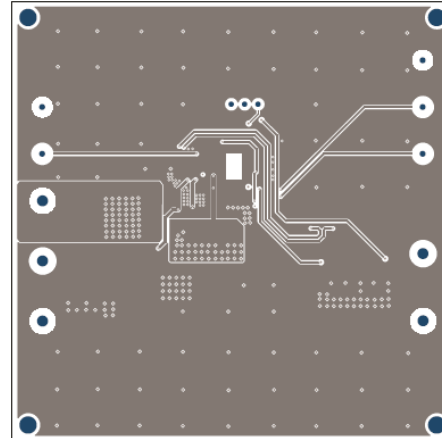

Figure 4— Middle Layer 2

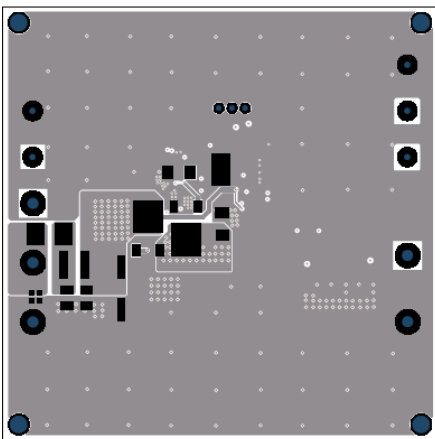

Figure 5—Bottom Layer

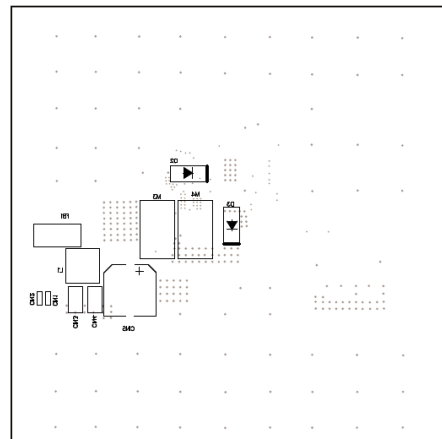

Figure 6—Bottom Silk Layer

QUICK START GUIDE

The output voltage of this board is set to 5V. The board layout accommodates most commonly used components.

1. Preset Power Supply to $6V \leq V_{IN} \leq 60V$.
2. Turn Power Supply off.
3. Connect Power Supply terminals to:
 - a. Positive (+): VIN
 - b. Negative (-): GND
4. Connect Load to:
 - a. Positive (+): VOUT
 - b. Negative (-): GND
5. The MP9928 is enabled on the evaluation board once VIN is applied.
6. Turn Power Supply on after making connections, the MP9928 will startup automatically.
7. To use the Enable function, apply a digital input to the EN pin. Drive EN higher than 1.3V to turn on EV9928-F-00B or less than 1V to turn it off.

NOTICE: The information in this document is subject to change without notice. Please contact MPS for current specifications. Users should warrant and guarantee that third party Intellectual Property rights are not infringed upon when integrating MPS products into any application. MPS will not assume any legal responsibility for any said applications.