

DESCRIPTION

The EV9486A-N-00A Evaluation Board is designed to demonstrate the performances of MPS' MP9486A which is a 4.5V-to-100V-input step-down converter.

The MP9486A employs hysteresis voltage control method to provide fast response to line or load transient. It integrates a high-side high voltage power MOSFET with a current limit of typical 3.5A. MPS's proprietary feedback control scheme minimizes the number of external components.

This board is configured for 5V step-down application. It can support 1A continuous load or 2A pulse load. The circuit requires only a minimal number of readily-available, standard, external components.

ELECTRICAL SPECIFICATION

Parameter	Symbol	Value	Units
Supply Voltage	V _{IN}	8 – 95	V
Output Voltage	V _{OUT}	5	V
Output Current	I _{OUT}	0-1	A

FEATURES

- 8V-to-95V Wide Input Range⁽¹⁾
- Hysteretic Control: Simple Compensation
- Up to 1MHz Switching Frequency
- Hiccup mode Short Circuit Protection
- Thermal Shut Down
- 170µA Quiescent Current
- Available in SOIC8 with Exposed Pad Package

Note: 1) MP9486A can support 4.5V-to-95V DC input, 8V minimum voltage is needed when V_{OUT} sets to 5V. MP9486A can support up to 100V input spike voltage.

APPLICATIONS

- Scooter, E-bike Control Power Supply
- Solar Energy System
- Automotive System Power
- Industrial Power Supply

All MPS parts are lead-free, halogen free, and adhere to the RoHS directive. For MPS green status, please visit MPS website under Quality Assurance.

"MPS" and "The Future of Analog IC Technology" are Registered Trademarks of Monolithic Power Systems, Inc.

EV9486A-N-00A EVALUATION BOARD



(L x W x H) 6.3cm x 6.3cm x 1.3cm

Board Number	MPS IC Number
EV9486A-N-00A	MP9486AGN

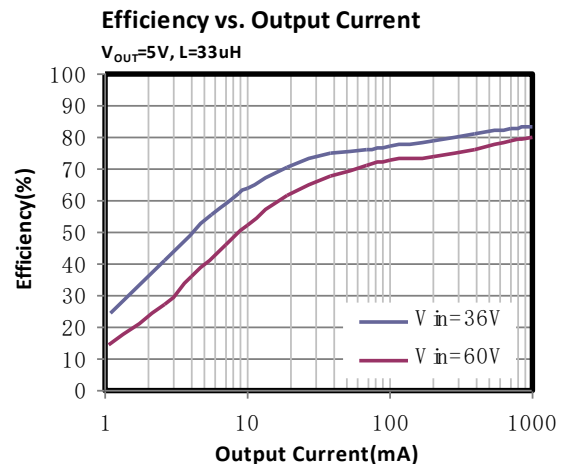

EVALUATION BOARD SCHEMATIC

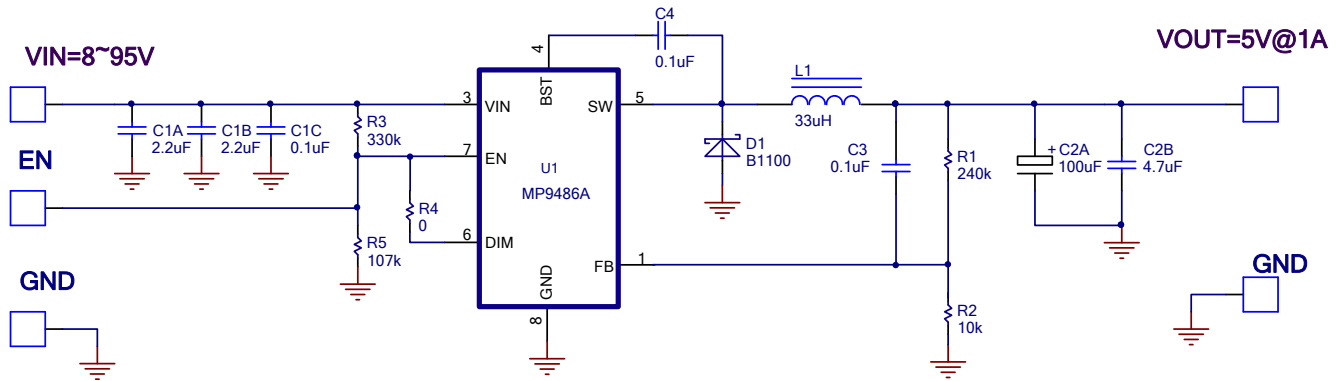

EV9486A-N-00A BILL OF MATERIALS

Qty	Ref	Value	Description	Package	Manufacturer	Part Number
2	C1A, C1B	2.2 μ F	Ceramic Cap., 100V, X7R	1210	muRata	GRM32ER72A225K
1	C1C	0.1 μ F	Ceramic Cap., 100V, X7R	0805	muRata	GCM21BR72A104K
1	C2A	100 μ F	10V, 0.74A solid tantalum capacitor, ESR=200m Ω	SMD (3.2x6.0)	VISHAY	TR3C107M010C0200
1	C2B	4.7 μ F	25V X7R Ceramic Capacitor	0805	muRata	GRM21AR71E475KL
2	C3,C4	0.1 μ F	25V Ceramic Capacitor	0603	muRata	GRM188R71E104KL
1	D1	B1100	100V,1A,schottky diode	SMA	DIODES	B1100-LS
1	L1	33 μ H	66 m Ω , Isat=2.9A inductor	SMD (10X10)		744771433
1	R1	240k	Film resistor, 1%	0603	YAGEO	RC0603FR-07240KL
1	R2	10k	Film resistor, 1%	0603	YAGEO	RC0603FR-0710KL
1	R3	330k	Film resistor, 1%	0603	YAGEO	RC0603FR-07330KL
1	R4	0	Film resistor, 5%	0603	YAGEO	RC0603JR-070RL
1	R5	107k	Film resistor, 1%	0603	YAGEO	RC0603FR-07107KL
1	U1	MP9486A	100V INPUT, 3.5A STEP-DOWN CONVERTER	SOIC8	MPS	MP9486AGN

EVB TEST RESULTS

Performance waveforms are tested on the evaluation board.

$V_{IN} = 60V$, $V_{OUT} = 5V$, $I_{OUT} = 1A$, $L=33\mu H$, $C_{OUT} = 100\mu F$, $T_A = +25^\circ C$, unless otherwise noted.

Efficiency vs. Output Current

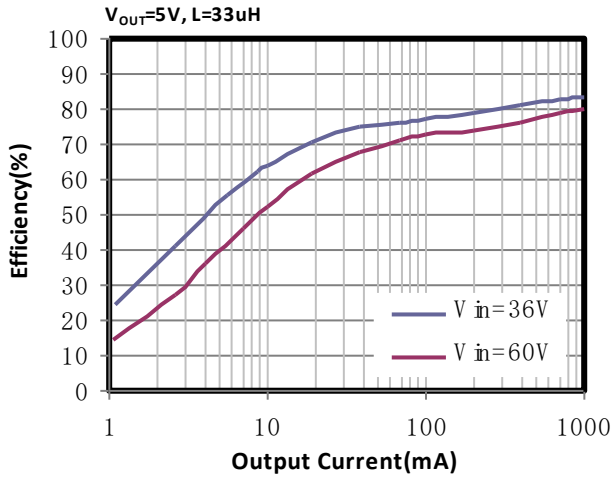

Load Regulation

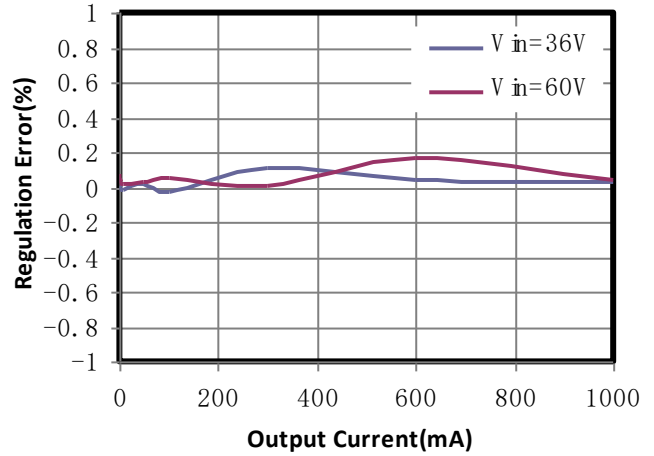

Line Regulation

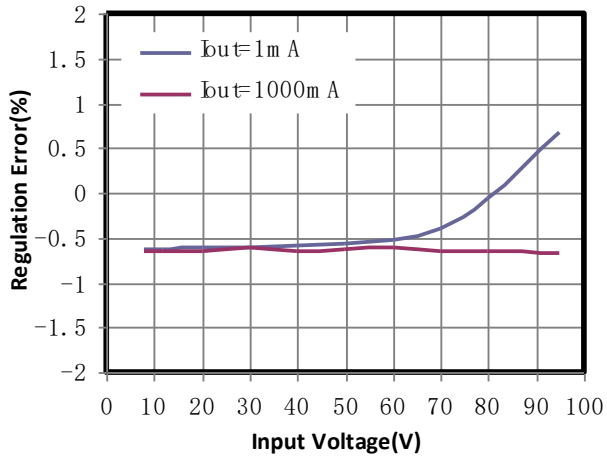

EVB TEST RESULTS *(continued)*

Performance waveforms are tested on the evaluation board.

$V_{IN} = 60V$, $V_{OUT} = 5V$, $I_{OUT} = 1A$, $L=33\mu H$, $C_{OUT} = 100\mu F$, $T_A = +25^\circ C$, unless otherwise noted.

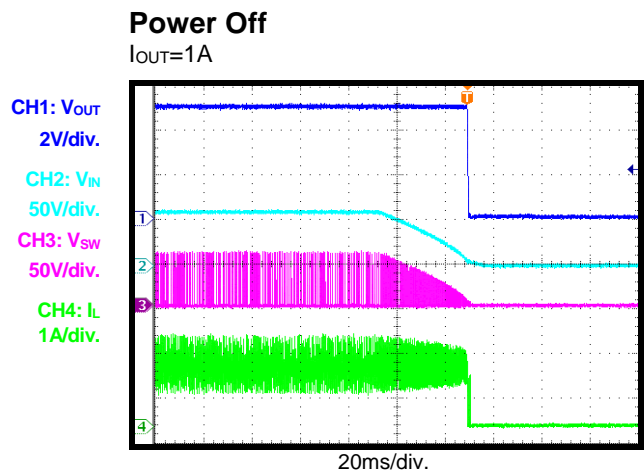
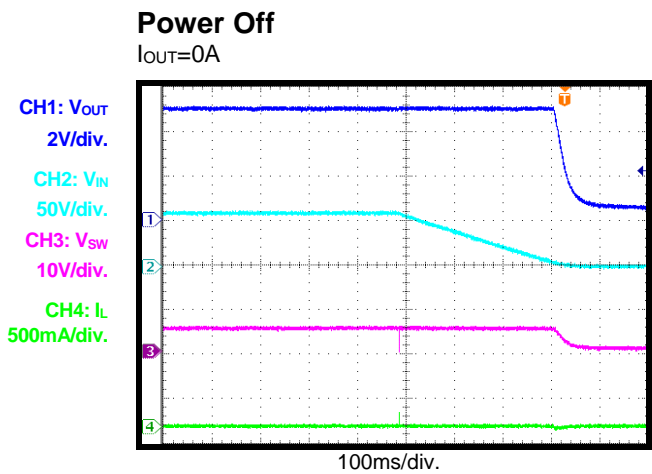
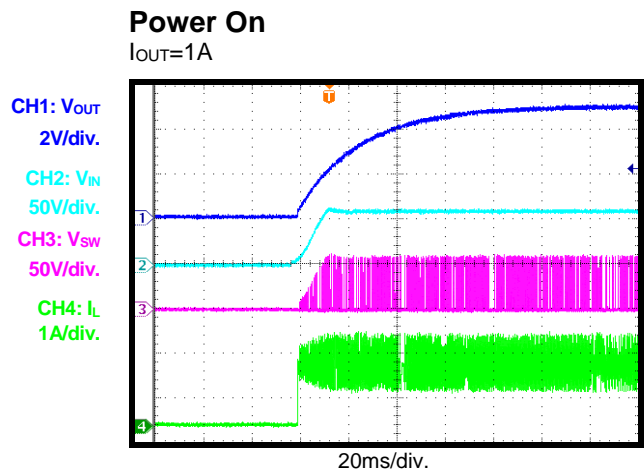
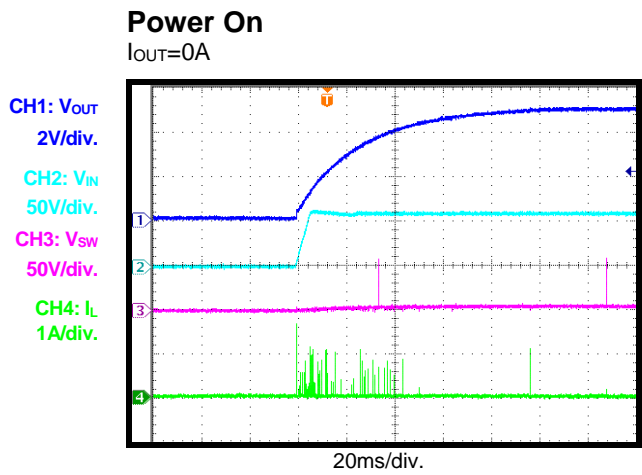
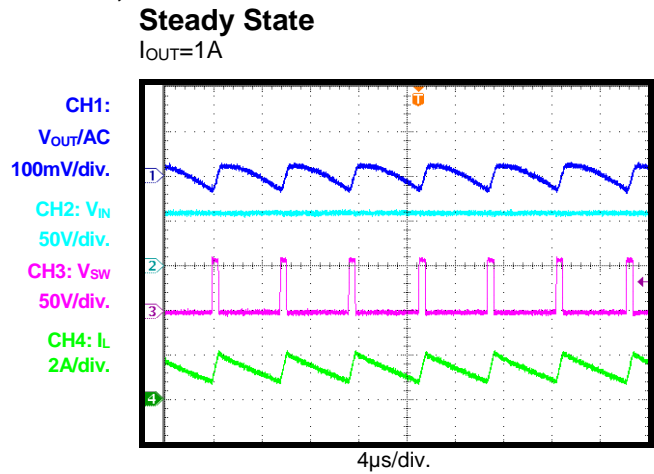
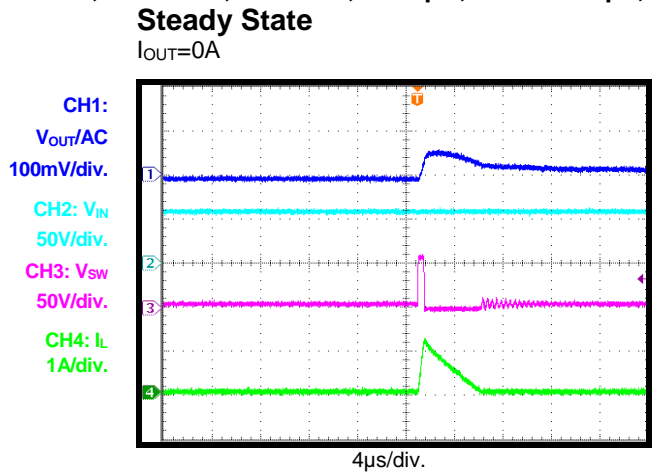

EVB TEST RESULTS (continued)

Performance waveforms are tested on the evaluation board.

$V_{IN} = 60V$, $V_{OUT} = 5V$, $I_{OUT} = 1A$, $L=33\mu H$, $C_{OUT} = 100\mu F$, $T_A = +25^\circ C$, unless otherwise noted.

EN Start-Up

$I_{OUT}=0A$

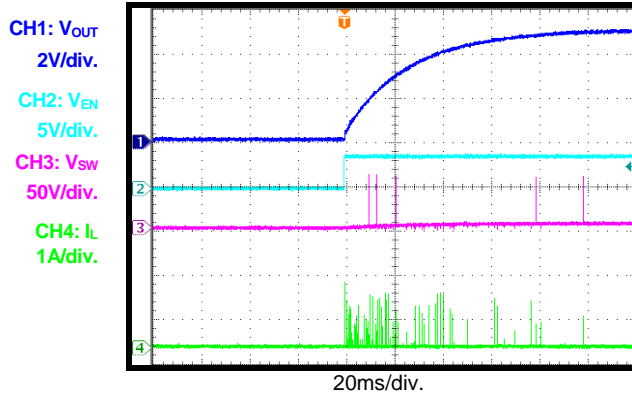

EN Start-Up

$I_{OUT}=1A$

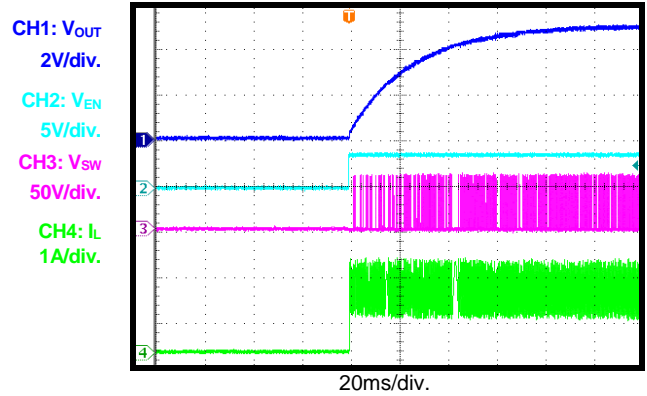

EN Shutdown

$I_{OUT}=0A$

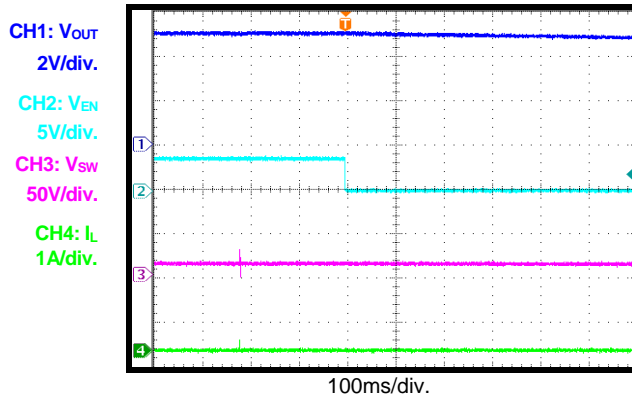

EN Shutdown

$I_{OUT}=1A$

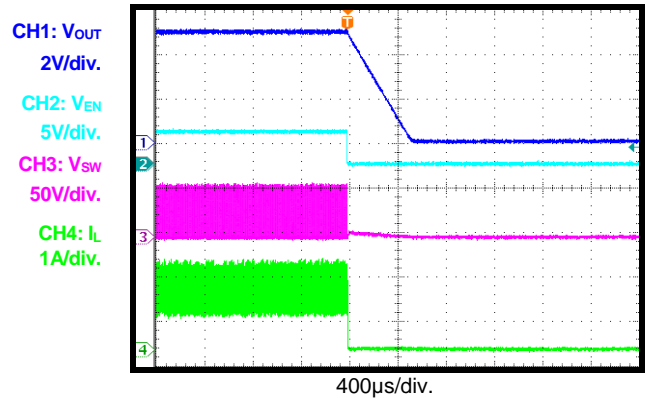

SCP Entry

$I_{OUT}=0A$

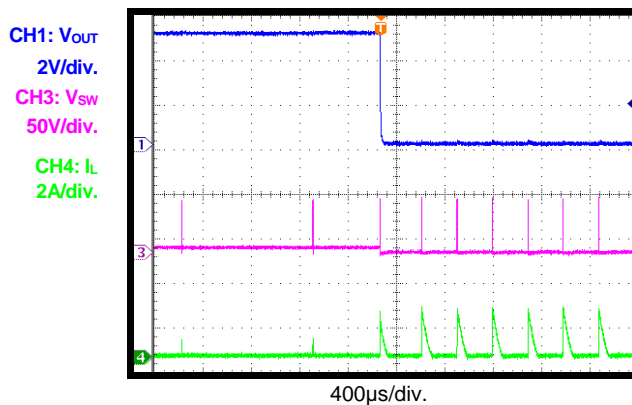

SCP Recovery

$I_{OUT}=0A$

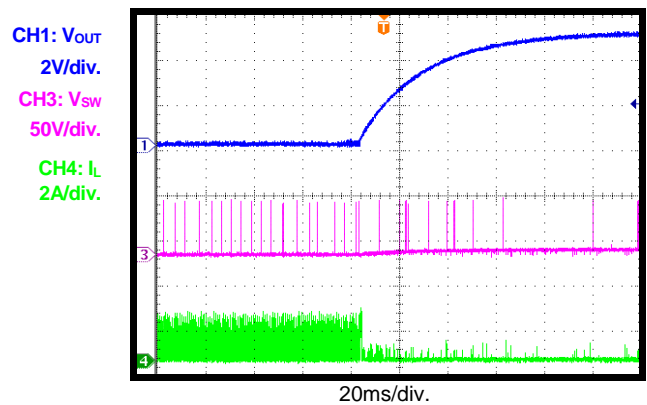

EV BOARD TEST RESULTS *(continued)*

Performance waveforms are tested on the evaluation board.

$V_{IN} = 60V$, $V_{OUT} = 5V$, $I_{OUT} = 1A$, $L=33\mu H$, $C_{OUT} = 100\mu F$, $T_A = +25^\circ C$, unless otherwise noted.

SCP Entry

$I_{OUT}=1A$

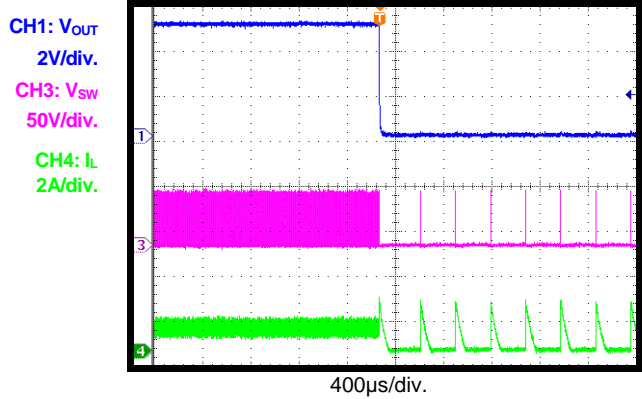

SCP Recovery

$I_{OUT}=1A$, E-load turn-on Threshold=0.32V

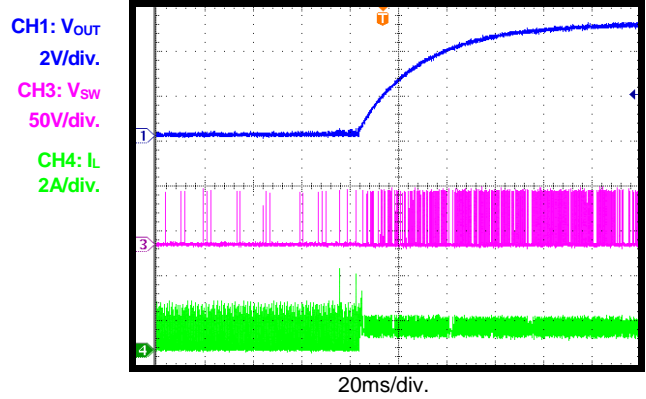

Load Transient

$I_{OUT}=0A \rightarrow 1A @ 70mA/\mu s$

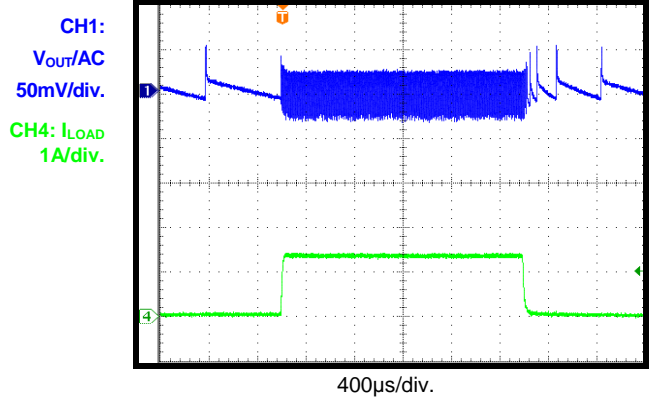

Load Transient

$I_{OUT}=1A \rightarrow 2A @ 70mA/\mu s$

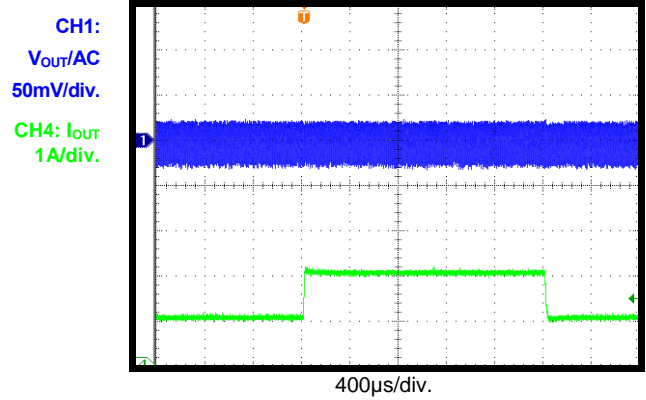

PRINTED CIRCUIT BOARD LAYOUT

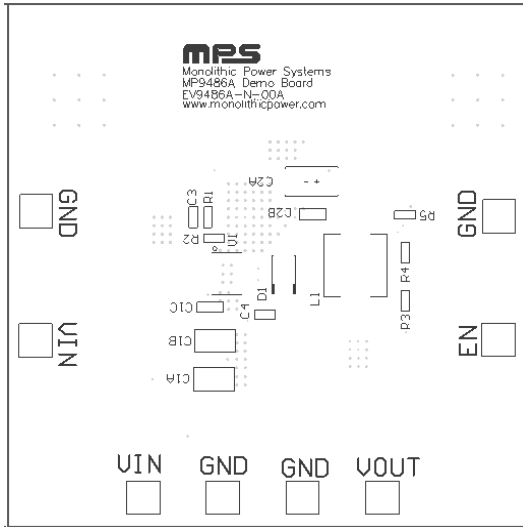

Figure 1: Top Silkscreen Layer

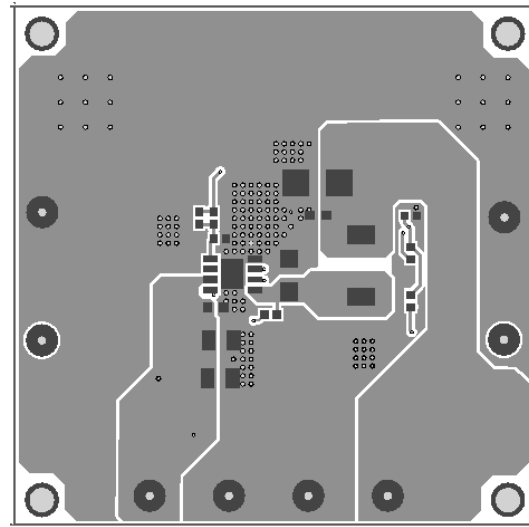

Figure 2: Top Layer

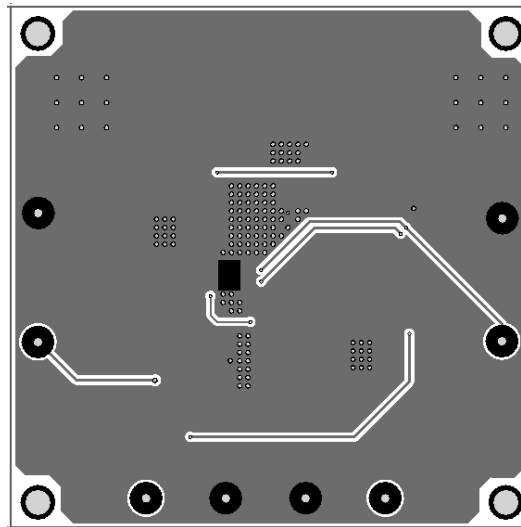

Figure 3: Bottom Layer

QUICK START GUIDE

The output voltage of this board is set to 5V. With an input ranging from 8V (lower input may cause insufficient BST voltage) to 95V, this board can provide load with 1A continuous current or 2A pulse current. To use this EVB for evaluation, you can do as below:

1. Preset Power Supply to between 8V and 95V.
2. Turn Power Supply off.
3. Preset Load to a value not greater than 1A. Note that due to the SCP mechanism MP9486A may startup into SCP mode if the load is on during startup and the turn-on threshold of the E-load is below 0.3V. To improve the startup capability C3's value should be greater.
4. Connect Power Supply terminals to:
 - a. Positive (+): VIN
 - b. Negative (-): GND
5. Connect Load to:
 - a. Positive (+): VOUT
 - b. Negative (-): GND
6. Turn Power Supply on after making connections. The MP9486A will automatically startup to work.

The output voltage VOUT can be programmed by changing R2. And the value of R2 can be calculated by the following formula:

$$R_2 = R_1 \times \frac{V_{FB}}{V_{OUT} - V_{FB}}$$

Where R1=240kΩ, and V_{FB}=0.2V.

7. If EN functions is preferred, apply a high level (>1.7V) turns on MP9486A, low level (<1V) turns off MP9486A. After being turned off, output voltage will be discharged to 0V due to load.

NOTICE: The information in this document is subject to change without notice. Please contact MPS for current specifications. Users should warrant and guarantee that third party Intellectual Property rights are not infringed upon when integrating MPS products into any application. MPS will not assume any legal responsibility for any said applications.