



The Future of Analog IC Technology®

# EV9473-L-00A

## High-Efficiency, Fast-Transient, 3.5A, 36V Step-Down Converter Evaluation Board

### DESCRIPTION

The EV9473-L-00A is an evaluation board for the MP9473, a high-efficiency step-down regulator with integrated power MOSFETs.

MP9473 offers a very compact solution to achieve a 3.5A, continuous-output current over a wide input-supply range with excellent load and line regulation. It also provides fast transient response and good stability for wide input-supply and load range.

The EV9473-L-00A is a fully assembled and tested evaluation board. It generates a +3.3V output voltage at load current up to 3.5A from a 7V to 36V input range. Switching frequency is set at 500kHz.

### ELECTRICAL SPECIFICATIONS

Parameter	Symbol	Value	Units
Input Voltage	$V_{IN}$	4.5 – 36	V
Output Voltage	$V_{OUT}$	3.3	V
Output Current	$I_{OUT}$	3.5	A

### FEATURES

- Wide 4.5V-to-36V Operating Input Range
- Guaranteed 3.5A, Continuous Output Current
- Internal 65mΩ High-Side, 30mΩ Low-Side Power MOSFETs
- Proprietary Switching-Loss-Reduction Technology
- 1.5% Reference Voltage
- Programmable Soft-Start Time
- Low Drop-out Mode
- SCP, OCP, UVP and Thermal Shutdown

### APPLICATIONS

- General Consumer
- USB Power Supplies
- Cigarette Lighter Adapters
- Power Supply for Chargers

All MPS parts are lead-free, halogen free, and adhere to the RoHS directive. For MPS green status, please visit MPS website under Quality Assurance.

“MPS” and “The Future of Analog IC Technology” are Registered Trademarks of Monolithic Power Systems, Inc.

### EV9473-L-00A EVALUATION BOARD



(L x W x H) 2.5" x 2.5" x 0.4"  
(6.4cm x 6.4cm x 1.0cm)

Board Number	MPS IC Number
EV9473-L-00A	MP9473GL

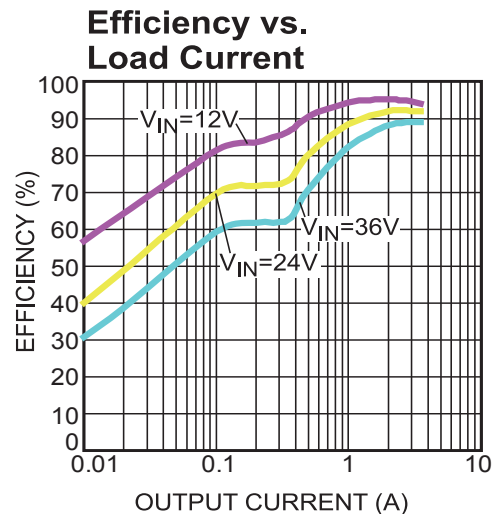

## EVALUATION BOARD SCHEMATIC

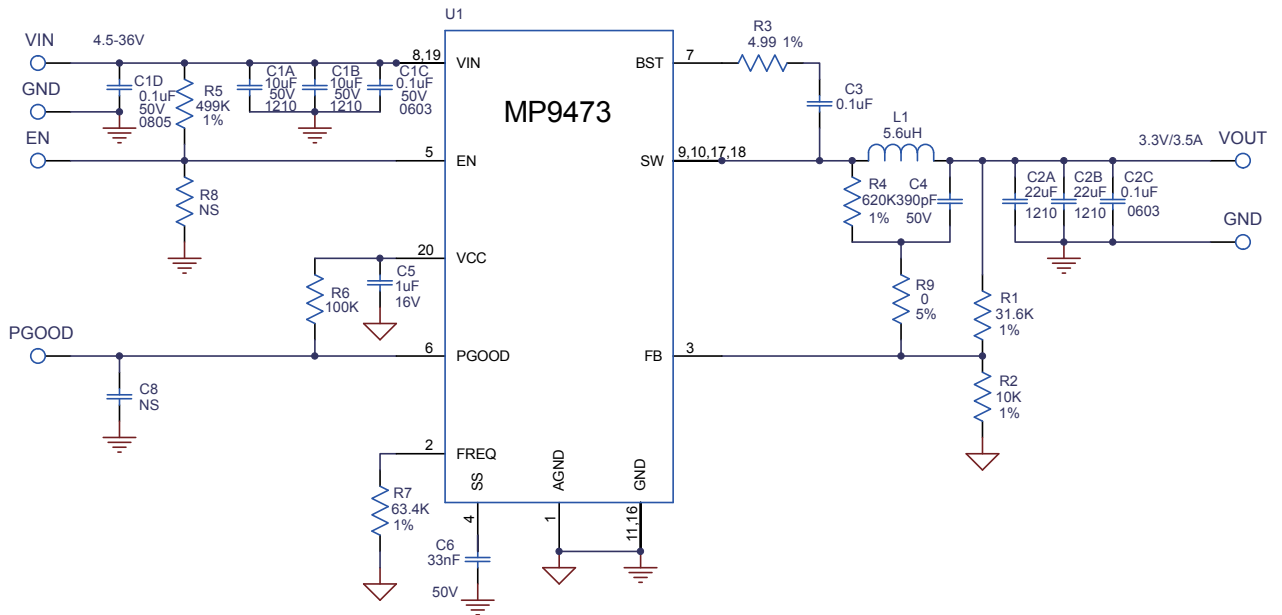

**EV9473-L-00A BILL OF MATERIALS**

Qty	RefDes	Value	Description	Package	Manufacturer	Manufacturer_P/N
2	C1A,C1B	10 $\mu$ F	Ceramic Cap., 50V, X7R	1210	muRata	GRM32ER71H106KA12L
3	C1C,C2C,C3	0.1 $\mu$ F	Ceramic Cap., 50V, X7R	0603	TDK	C1005X7R1C104K
1	C1D	0.1 $\mu$ F	Ceramic Cap., 50V, X7R	0805	muRata	GRM21BR72A104KAC4L
2	C2A,C2B	22 $\mu$ F	Ceramic Cap., 16V, X7R	1210	muRata	GRM32ER71C226KE79
1	C4	390pF	Ceramic Cap., 50V, C0G	0402	muRata	GRM1885C1H391JA01D
1	C5	1 $\mu$ F	Ceramic Cap., 25V, X7R	0402	muRata	GRM188R71C105KA12D
1	C6	33nF	Ceramic Cap., 16V, X7R	0402	muRata	GRM188R71H333KA61D
1	L1	5.6 $\mu$ H	Inductor, 15mOhm DCR, 10A	SMD	Coilcraft	XAL6060-562ME
1	R1	31.6k	Film Res., 1%	0402	Yageo	RC0603FR-0731K6L
1	R2	10k	Film Res., 1%	0402	Yageo	RC0603FR-0710KL
1	R3	4.99 $\Omega$	Film Res., 1%	0402	Yageo	RC0603FR-074R99L
1	R4	620k	Film Res., 1%	0402	Yageo	RC0603FR-07620KL
1	R5	499k	Film Res., 1%	0402	Yageo	RC0603FR-07499KL
1	R6	100k	Film Res., 5%	0402	Yageo	RC0603FR-07100KL
1	R7	63.4k	Film Res., 1%	0402	Yageo	RC0603FR-0763K4L
1	R9	0 $\Omega$	Film Res., 5%	0402	Yageo	RC0603FR-070RL
	R8	NS				
1	U1	MPQ4473	Step-Down Regulator	QFN20- 3x4	MPS	MPQ4473GL

## EVB TEST RESULTS

Performance waveforms are tested on the evaluation board.

$V_{IN} = 24V$ ,  $V_{OUT} = 3.3V$ ,  $T_A = 25^\circ C$ , unless otherwise noted.

**Output Voltage Ripple**

$I_{OUT} = 0A$

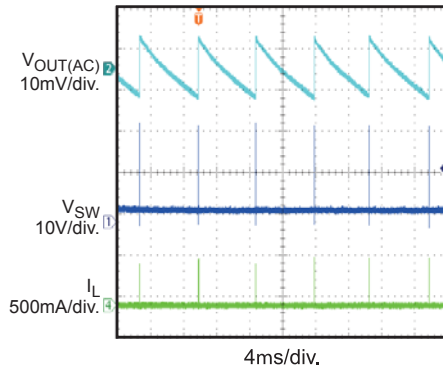

**Output Voltage Ripple**

$I_{OUT} = 3.5A$

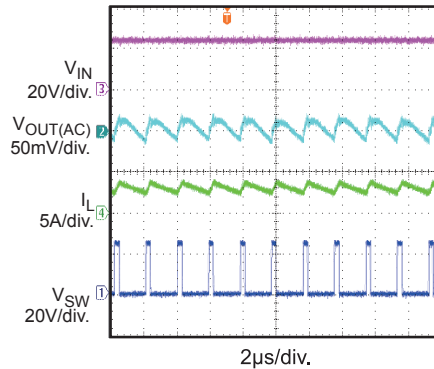

**Start-up Through  $V_{IN}$**

$I_{OUT} = 0A$

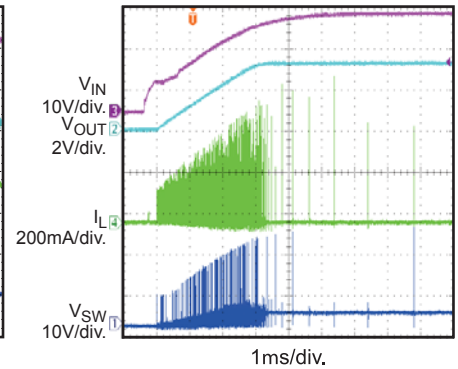

**Start-up Through  $V_{IN}$**

$I_{OUT} = 3.5A$

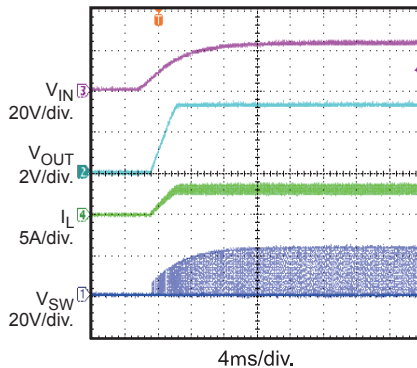

**Shutdown Through  $V_{IN}$**

$I_{OUT} = 0A$

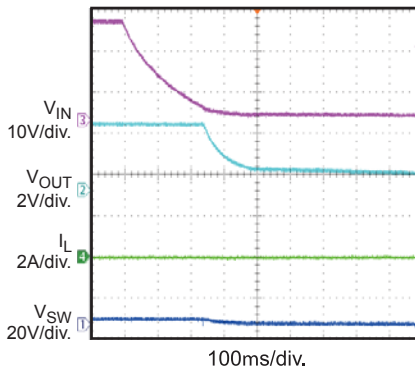

**Shutdown Through  $V_{IN}$**

$I_{OUT} = 3.5A$

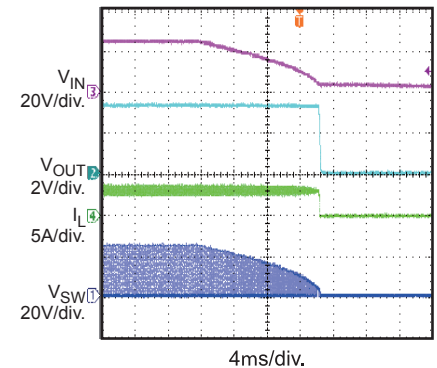

**Start-up Through EN**

$I_{OUT} = 0A$

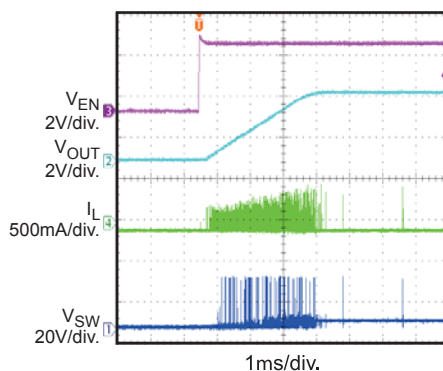

**Start-up Through EN**

$I_{OUT} = 3.5A$

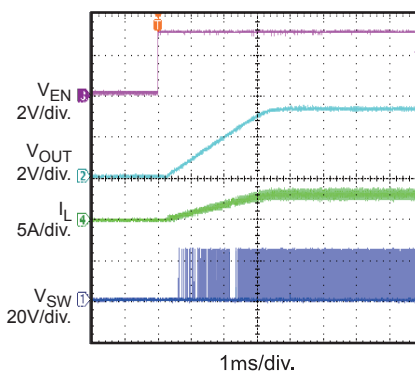

**Shutdown Through EN**

$I_{OUT} = 0A$

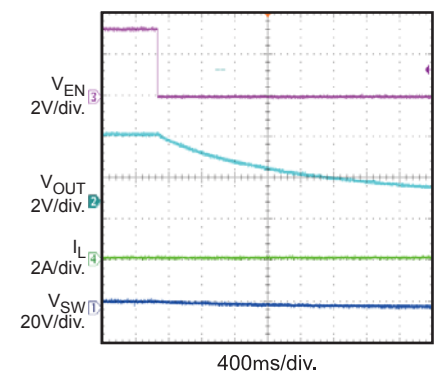

## EVB TEST RESULTS *(continued)*

Performance waveforms are tested on the evaluation board.

$V_{IN} = 24V$ ,  $V_{OUT} = 3.3V$ ,  $T_A = 25^\circ C$ , unless otherwise noted.

**Shutdown Through EN**

$I_{OUT} = 3.5A$

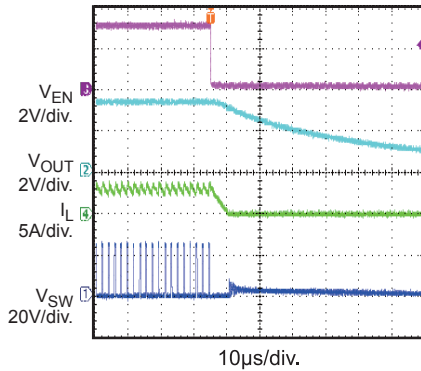

**Short Circuit Entry**

$I_{OUT} = 0A$

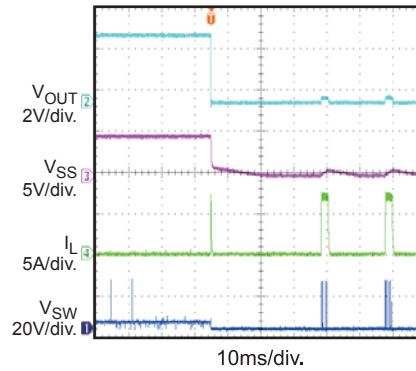

**Short Circuit Entry**

$I_{OUT} = 3.5A$

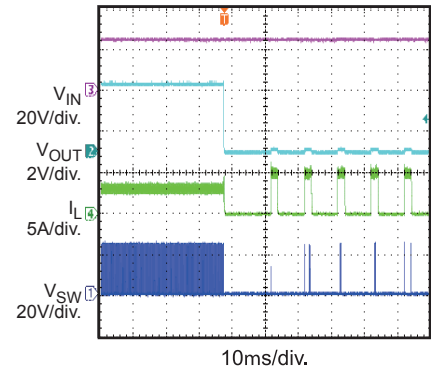

**Short Circuit Steady State**

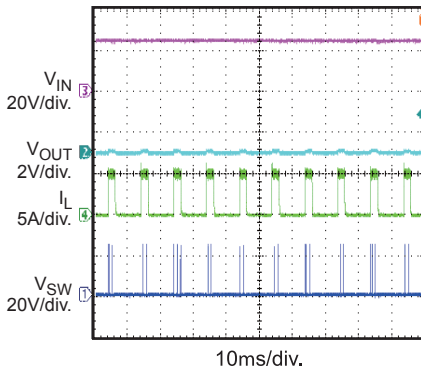

**Load Transient**

$I_{OUT} = 1A-3.5A$

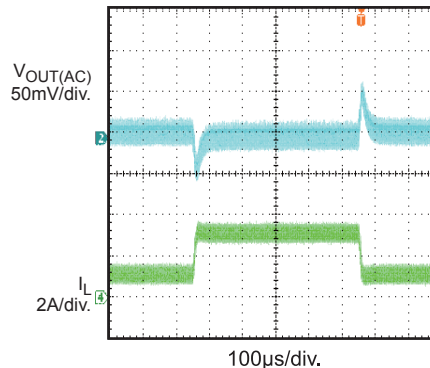

**Short Circuit Recovery**

$I_{OUT} = 0A$

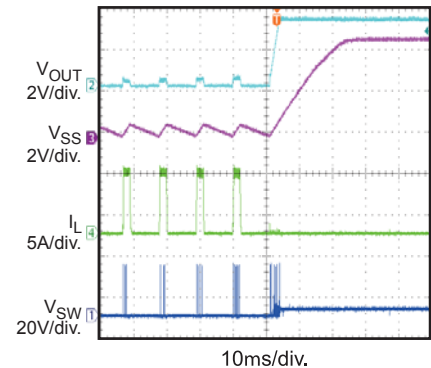

**Short Circuit Recovery**

$I_{OUT} = 3.5A$

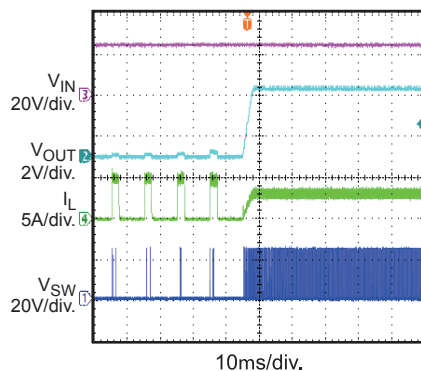

**Power Good Through EN Start-up**

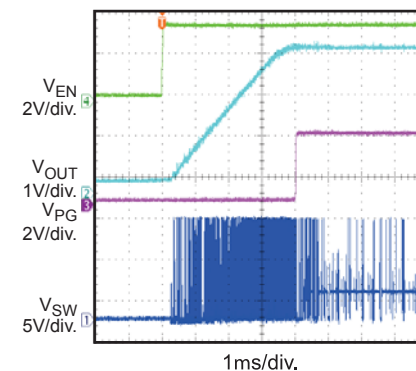

**Power Good Through EN Shutdown**

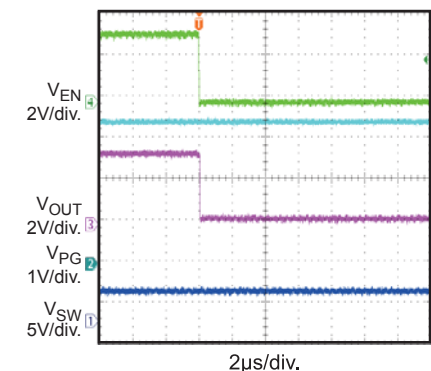

### PRINTED CIRCUIT BOARD LAYOUT

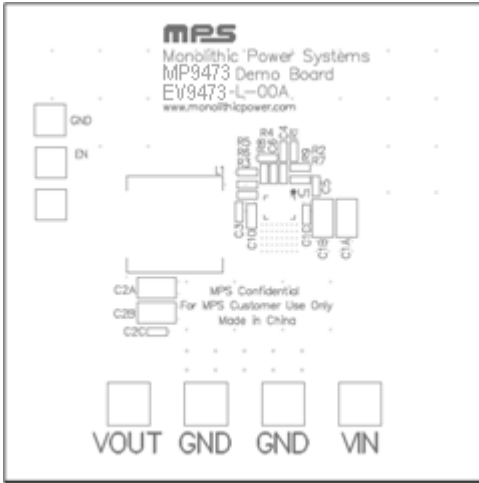

Figure 1—Top Silk Layer

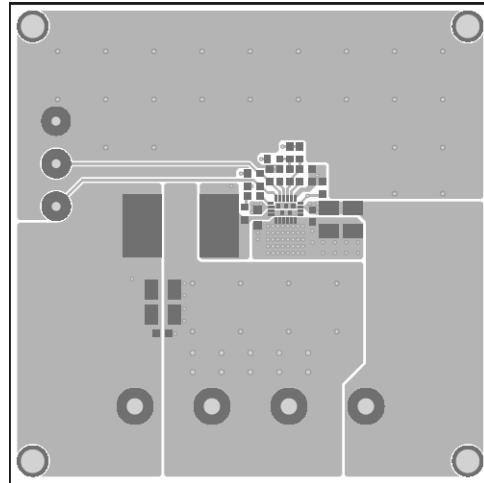

Figure 2—Top Layer

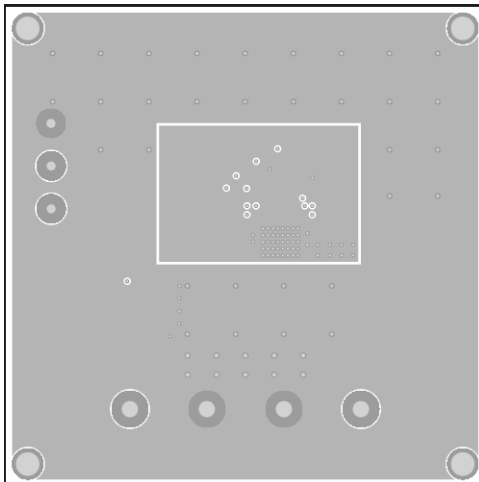

Figure 3—Inner1 Layer

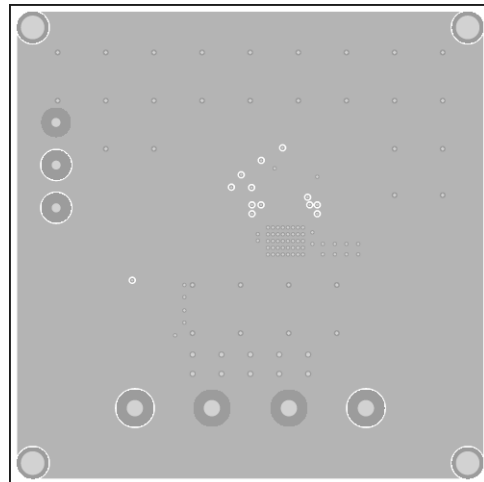

Figure 4—Inner2 Layer

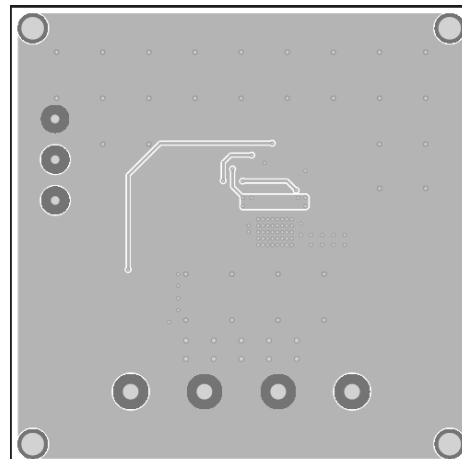

Figure 5—Bottom Layer

## QUICK START GUIDE

1. Connect the positive and negative terminals of the load to the VOUT and GND pins, respectively.
2. Preset the power supply output to between 4.5 and 36V, and then turn it off.
3. Connect the positive and negative terminals of the power supply output to the VIN and GND pins, respectively.
4. Turn the power supply on. The MP9473GL will automatically startup.
5. To use the Enable function, apply a digital input to the EN pin. Drive EN higher than 1.25V to turn on the regulator, drive EN less than 0.86V to turn it off.
6. An input under voltage lockout (UVLO) function is implemented by the addition of a resistor divider R5 and R8. The EN threshold is 0.86V (falling edge), so  $V_{IN}$  UVLO threshold is.  
$$0.86 \times \left(1 + \frac{R5}{R8}\right)$$
7. Use R1 and R2 to set the output voltage with  $V_{FB} = 0.815V$ . For  $R2 = 10k\Omega$ , R1 can be determined by:  $R1 = 12.27 \times (V_{OUT} - 0.815)$  (k $\Omega$ ). Follow the Application Information section in the device datasheet to recalculate the compensation, inductor and output capacitor values when output voltage is changed.

**NOTICE:** The information in this document is subject to change without notice. Users should warrant and guarantee that third party Intellectual Property rights are not infringed upon when integrating MPS products into any application. MPS will not assume any legal responsibility for any said applications.