



The Future of Analog IC Technology®

# EV9186-Q-00A

## 20V, 6A 500kHz Synchronous Step-down Converter EV Board

### DESCRIPTION

The EV9186-Q-00A is for demonstrating MPS's MP9186, a high-frequency, synchronous, rectified, step-down, switch-mode converter with internal power MOSFETs. MP9186 offers a very compact solution to achieve 6A continuous output current over a wide input supply range with excellent load and line regulation. The MP9186 operates at high efficiency over a wide output current load range.

Current-mode operation provides fast transient response and eases loop stabilization. The full protection features include over-current protection and thermal shutdown.

The MP9186 requires a minimal number of readily-available standard external components and comes in a space saving 3x3mm 14-pin QFN package.

### ELECTRICAL SPECIFICATION

Parameter	Symbol	Value	Units
Input Voltage	$V_{IN}$	5 – 20	V
Output Voltage	$V_{OUT}$	1	V
Output Current	$I_{OUT}$	6	A

### FEATURES

- Wide 5V-to-20V Operating Input Range
- 6A Output Current
- Low  $R_{DS(ON)}$  Internal Power MOSFETs
- Programmable Switching Frequency
- Programmable EN Delay
- Frequency SYNC from 300kHz-to-2MHz External Clock
- Low Power Mode Selectable by External Signal
- External Soft-Start
- OCP and Thermal Shutdown
- Available in 14-pin QFN3x3 Package

### APPLICATIONS

- DSL Modems
- Cable Modems
- Set Top Boxes

All MPS parts are lead-free and adhere to the RoHS directive. For MPS green status, please visit MPS website under Products, Quality Assurance page.

"MPS" and "The Future of Analog IC Technology" are registered trademarks of Monolithic Power Systems, Inc.

### EV9186-Q-00A EVALUATION BOARD



Board Number	MPS IC Number
EV9186-Q-00A	MP9186GQ

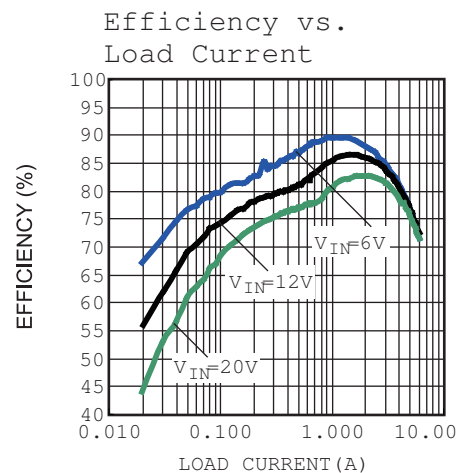

## EVALUATION BOARD SCHEMATIC

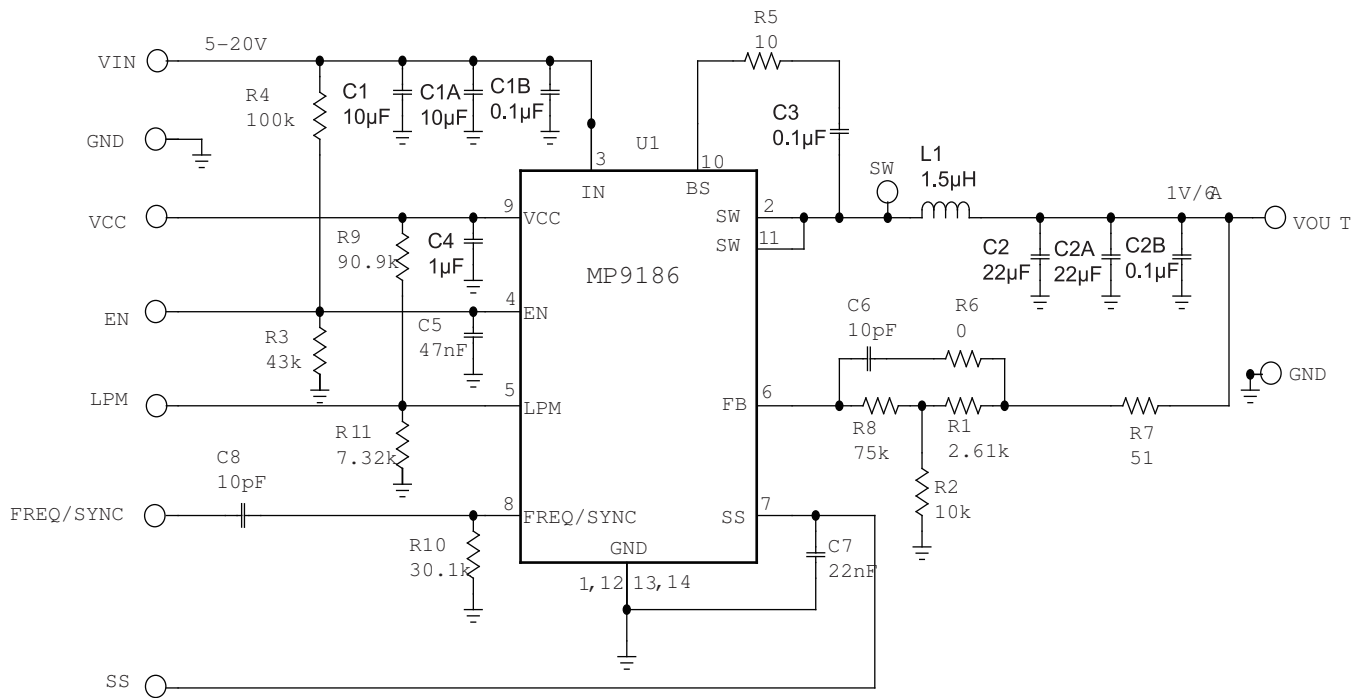

## EV9186-Q-00A BILL OF MATERIALS

Qty	Ref	Value	Description	Package	Manufacturer	Part Number
2	C1,C1A	10µF	Ceramic Cap., 25V, X7R	1210	Murata	GRM32DR71E106KA12L
2	C1B,C2B	0.1µF	Ceramic Cap., 25V, X7R	0805	Murata	GRM21BR71E104KA01L
2	C2,C2A	22µF	Ceramic Cap., 6.3V, X5R	1210	Murata	GRM32DR60J226KA01L
1	C3	0.1µF	Ceramic Cap., 25V, X7R	0603	Murata	GRM188R71E104KA01D
1	C4	1µF	Ceramic Cap., 6.3V, X5R	0603	Murata	GRM188R60J105KE19D
1	C5	47nF	Ceramic Cap., 25V, X7R	0603	Murata	GRM188R71E473KA01D
2	C6,C8	10pF	Ceramic Cap., 50V, NP0	0603	Murata	GRM1885C1H180JA01D
1	C7	22nF	Ceramic Cap., 50V, X7R	0603	Murata	GRM188R71H223KA01D
1	R1	2.61kΩ	Film Res., 1%	0603	Yageo	9C06031A2612FKHFT
1	R2	10kΩ	Film Res., 1%	0603	Yageo	9C06031A1002FKHFT
1	R3	43kΩ	Film Res., 1%	0603	Yageo	9C06031A4302FKHFT
1	R4	100kΩ	Film Res., 1%	0603	Yageo	9C06031A1003KHFT
1	R5	10Ω	Film Res., 5%	0603	Yageo	9C06031A10R0JLHFT
1	R6	0Ω	Film Res., 5%	0603	Yageo	RC0603JR-070R0L
1	R7	51Ω	Film Res., 5%	0603	Yageo	RC0603JR-0751RL
1	R8	75kΩ	Film Res., 1%	0603	Yageo	9C06031A7502FKHFT
1	R9	90.9kΩ	Film Res., 1%	0603	Yageo	9C06031A9092FKHFT
1	R10	30.1kΩ	Film Res., 1%	0603	Yageo	9C06031A3012FKHFT
1	R11	7.32kΩ	Film Res., 1%	0603	Yageo	9C06031A7321FKHFT
1	L1	1.5µH	DCR=6.6mΩ, Is=14A	7x6.9x4mm	Würth	744311150
1	U1	MP9186	Step-Down Converter	QFN14 (3x3)	MPS	MP9186GQ

## EVB TEST RESULTS

Performance waveforms are tested on the evaluation board.

$V_{IN}=12V$ ,  $V_{OUT}=1V$ ,  $T_A = 25^{\circ}C$ , unless otherwise noted.

Input / Output Ripple  
 $I_{OUT} = 0A$

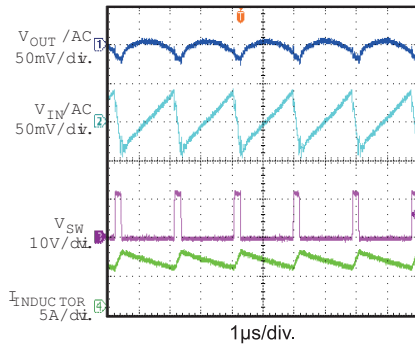

Load Transient Reponse  
 $I_{OUT} = 3A - 16A$

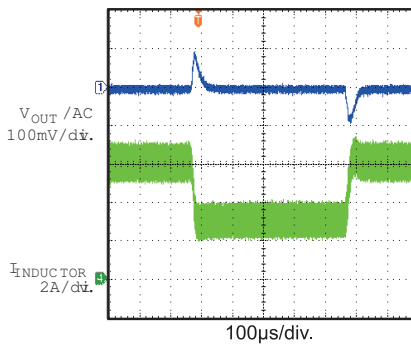

Startup Through Enable  
 $I_{OUT} = 0A$

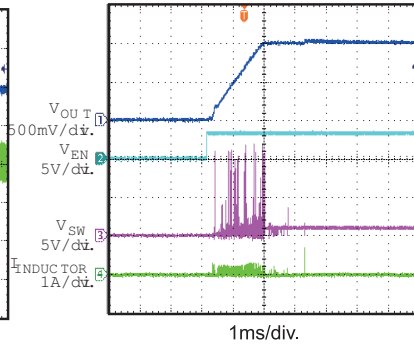

Startup Through Enable  
 $I_{OUT} = 0A$

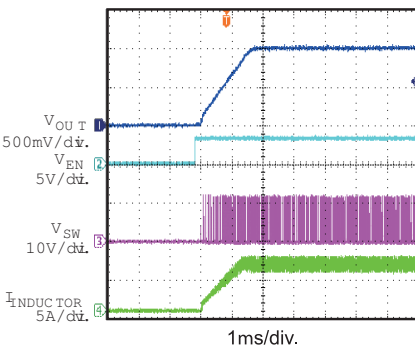

Shutdown Through Enable  
 $I_{OUT} = 0A$

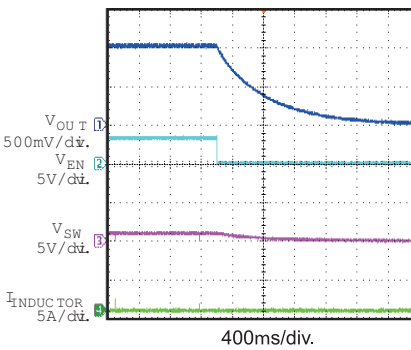

Shutdown Through Enable  
 $I_{OUT} = 0A$

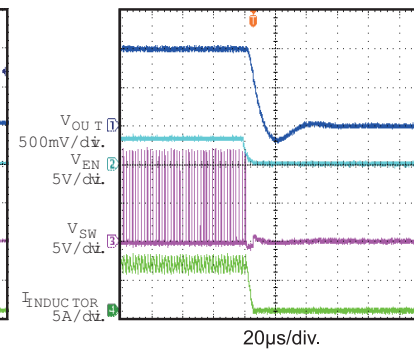

Short Entry  
 $I_{OUT} = 0A$

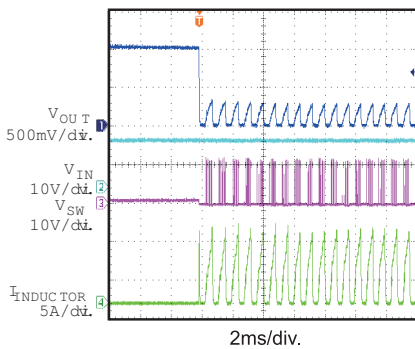

Short Recovery  
 $I_{OUT} = 0A$

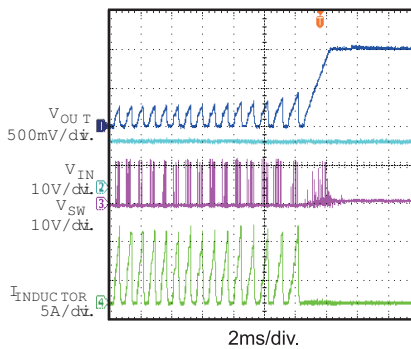

Case Temperature Rise vs. Output Current

$V_{IN}=12V$ ,  $I_{OUT}=1A-6A$ , 4 Layers PCB  
Size: 6.35cm x 6.35cm

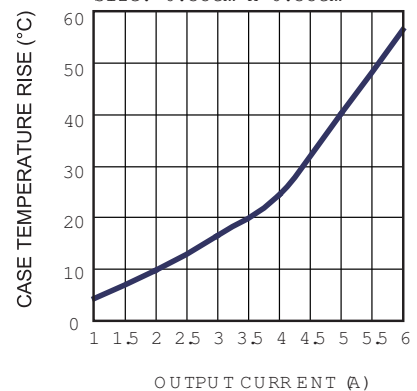

## PRINTED CIRCUIT BOARD LAYOUT

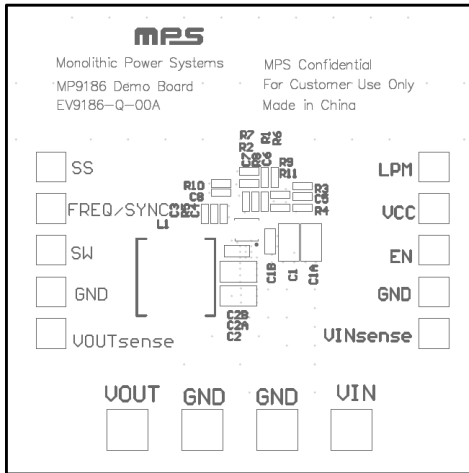

Figure 1—Top Silk Layer

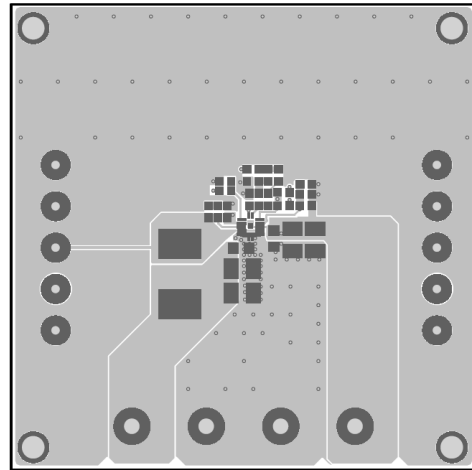

Figure 2—Top Layer

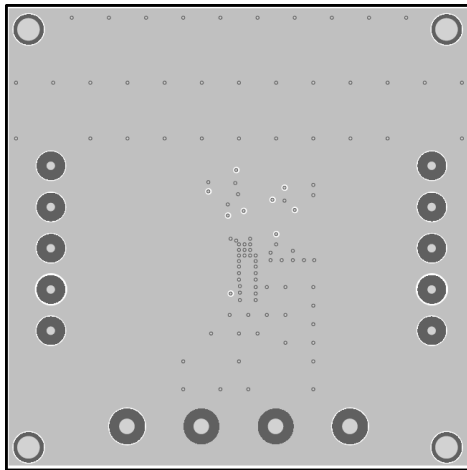

Figure 3—Inner 1 Layer

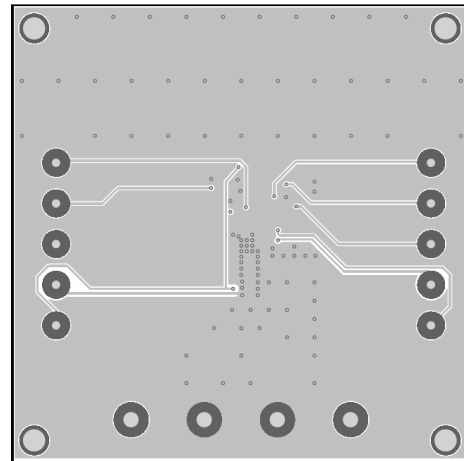

Figure 4— Inner 2 Layer

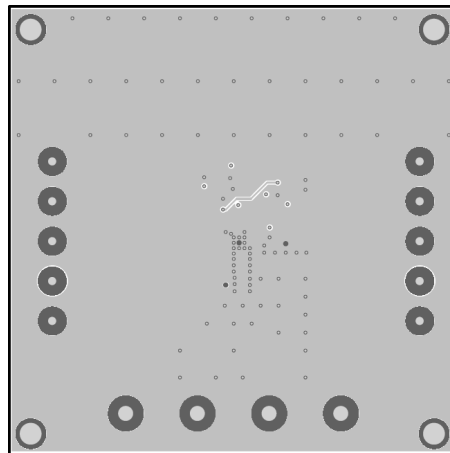

Figure 5—Bottom Layer

## QUICK START GUIDE

1. Connect the positive and negative terminals of the load to the VOUT and GND pins, respectively.
2. Preset the power supply output between 5V and 20V, and then turn off the power supply.
3. Connect the positive and negative terminals of the power supply output to the VIN and GND pins, respectively.
4. Turn the power supply on. The board will automatically start up.
5. To use the Enable function, apply a digital input to the EN pin. Drive EN higher than 1.6V to turn on the regulator or less than 0.4V to turn it off.
6. Apply up to 2MHz frequency logic level clock signal to the SYNC pin to synchronize the device to an external clock. The duty cycle is not critical.

**NOTICE:** The information in this document is subject to change without notice. Please contact MPS for current specifications. Users should warrant and guarantee that third party Intellectual Property rights are not infringed upon when integrating MPS products into any application. MPS will not assume any legal responsibility for any said applications.