

DESCRIPTION

The EV8867-LE-00A is used for demonstrating the performance of MPS's MP8867. MP8867 is a highly integrated and high frequency synchronous step-down switcher with I²C control interface. It is optimized to support up to 8A load current over an input supply range from 4.5V to 17V with excellent load and line regulation.

Current-Mode operation provides fast transient response and eases loop stabilization. The reference voltage level can be controlled, on-the fly through an I²C serial interface. Reference voltage range can be adjusted from 0.6V to 1.87V in 10mV steps. Voltage scaling slew rate, enable and power saving mode are also selectable through the I²C interface. Full protection features include over voltage, hiccup over-current protection and thermal shut down.

The MP8867 is available in QFN-14(3mmx4mm) package.

ELECTRICAL SPECIFICATION

Parameter	Symbol	Value	Units
Input Voltage	V _{IN}	4.5– 17	V
Output Voltage	V _{OUT}	1	V
Output Current	I _{OUT}	8	A

FEATURES

- Wide 4.5V-to-17V Operating Input Range
- 1% Internal Reference Accuracy
- I²C Programmable Reference Output Voltage
- Range from 0.6V to 1.87V in 10mV Steps with Slew Rate Control
- I²C Selectable Switching Frequency.
- 200kHz-2MHz Synchronized External Clock
- OTP, OCP Hiccup Indication Via I²C
- Selectable PSM and Fs Through I²C
- Programmable Soft Start Time
- Open-Drain Power Good Indicator
- Small 3x4mm QFN 14 Package

APPLICATIONS

- SoC and Media Processors
- FPGA-based Systems
- ASIC Supplies
- Distributed Power Systems

All MPS parts are lead-free, halogen free, and adhere to the RoHS directive. For MPS green status, please visit MPS website under Quality Assurance. "MPS" and "The Future of Analog IC Technology" are Registered Trademarks of Monolithic Power Systems, Inc.

EV8867-LE-00A EVALUATION BOARD



Board Number	MPS IC Number
EV8867-LE-00A	MP8867GLE

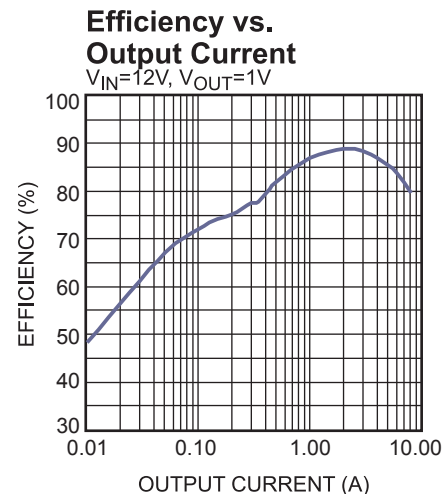

EVALUATION BOARD SCHEMATIC

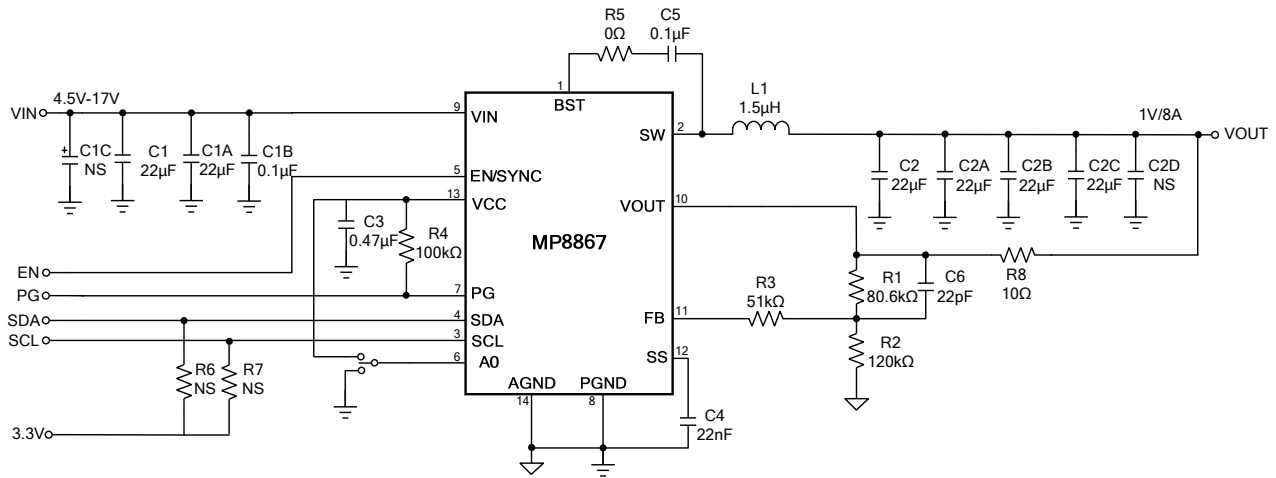

EV8867-LE-00A BILL OF MATERIALS

Qty	RefDes	Value	Description	Package	Manufacturer	Manufacturer P/N
1	R1	80.6k	Film Res,1%	0603	ROYAL	RC0603FR-0780K6L
1	R2	120k	Film Res,1%	0603	ROYAL	RL0603FR-07120KL
1	R3	51k	Film Res,1%	0603	ROYAL	RL0603FR-0751KL
1	R5	0Ω	Film Res,1%	0402	RALEC	RTT020000FTP
1	R4	100k	Film Res,1%	0603	ROYAL	RL0603FR-07100KL
2	R6, R7	NS				
1	R8	10 Ω	Film Res,1%	0603	ROYAL	RL0603FR-0710RL
2	C1B, C5	0.1μF	Ceramic Cap,25V,X7R	0603	muRata	GRM188R71E104KA01D
2	C1A, C1	22μF	Ceramic Cap,25V,X5R	1206	muRata	GRM31CR61E226KE15L
4	C2, C2A, C2B, C2C	22μF	Ceramic Cap, 25V,X5R	0805	muRata	GRM21BR61E226ME44L
2	C2D, C1C	NS				
1	C3	0.47 μF	Ceramic Cap,16V,X7R	0603	muRata	GRM188R71C474KA88D
1	C4	22nF	Ceramic Cap,16V,X7R	0603	muRata	GRM188R71C223KA01D
1	C6	22pF	Ceramic Cap,50V,C0G	0603	muRata	GRM1885C1H220JA01D
1	L1	1.5μH	IR=11A,Isat=14A, DCR=6.6m Ω	SMD	Wurth	744 311 150
1	U1	MP8867	Step-Down Converter with I2C Interface	QFN14 (3*4)	MPS	MP8867GLE

EVB TEST RESULTS

Performance waveforms are tested on the evaluation board.

V_{IN} = 12V, V_{OUT} = 1V, L = 1.5μH, T_A = 25°C, unless otherwise noted.

Short Entry

I_{OUT} = 0A

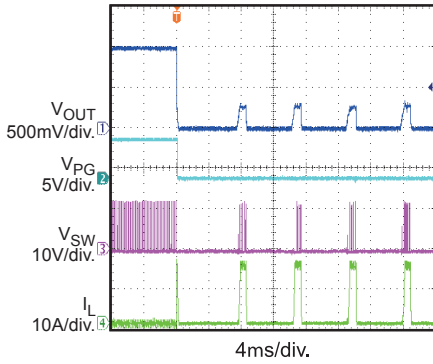

Short Recovery

I_{OUT} = 0A

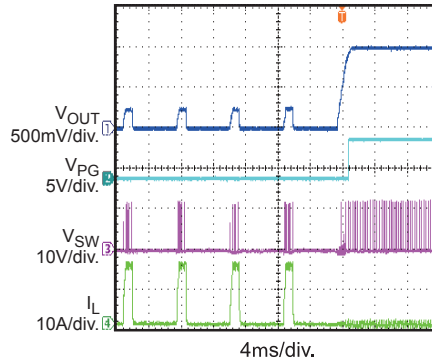

Start-Up through Enable

I_{OUT} = 0A

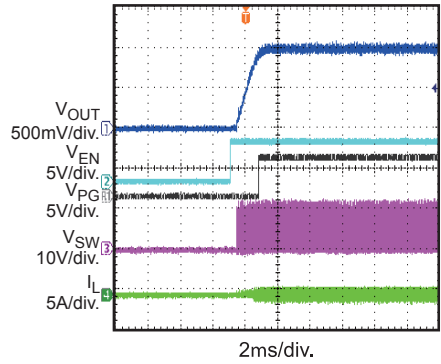

Start-Up through Enable

I_{OUT} = 8A

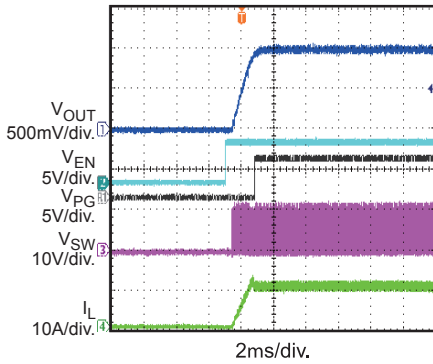

Shutdown through Enable

I_{OUT} = 0A

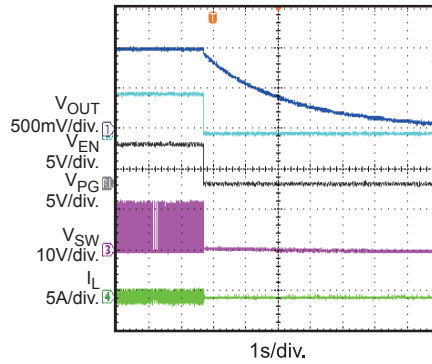

Shutdown through Enable

I_{OUT} = 8A

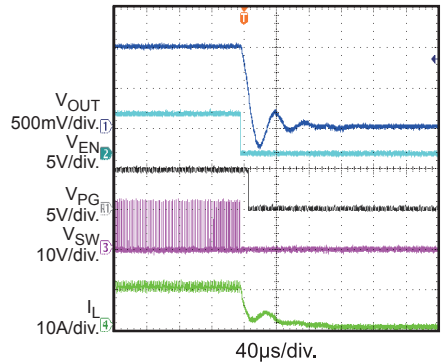

Start-Up through Input Voltage

I_{OUT} = 0A

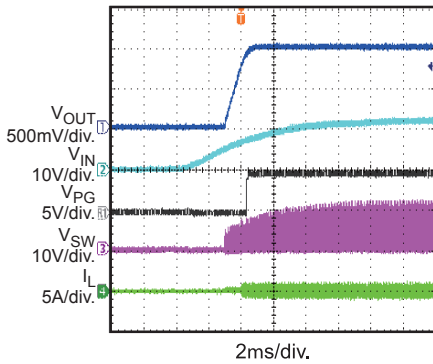

Start-Up through Input Voltage

I_{OUT} = 8A

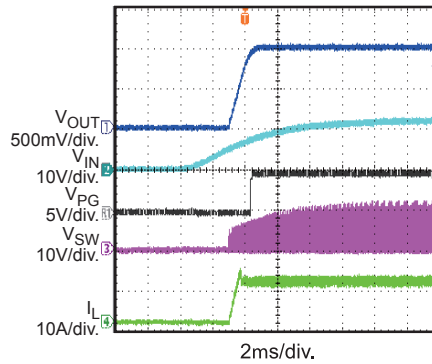

Shutdown through Input Voltage

I_{OUT} = 0A

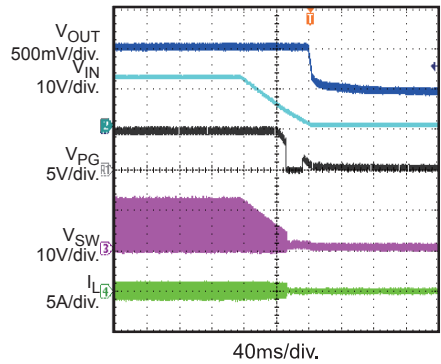

EVB TEST RESULTS (continued)

Performance waveforms are tested on the evaluation board.

V_{IN} = 12V, V_{OUT} = 1V, L = 1.5μH, T_A = 25°C, unless otherwise

Shutdown through Input Voltage
I_{OUT} = 8A

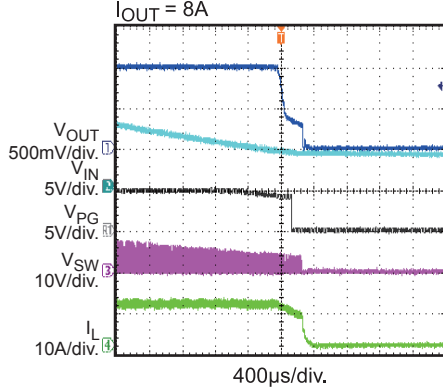

Input/Output Ripple
I_{OUT} = 8A

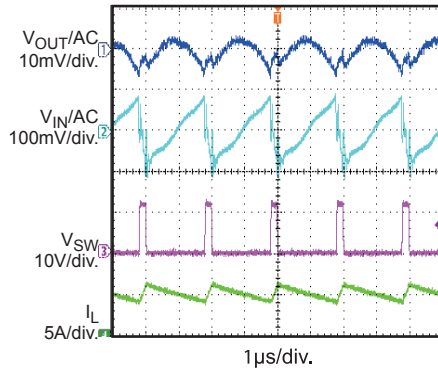

Input/Output Ripple
I_{OUT} = 0A, PFM

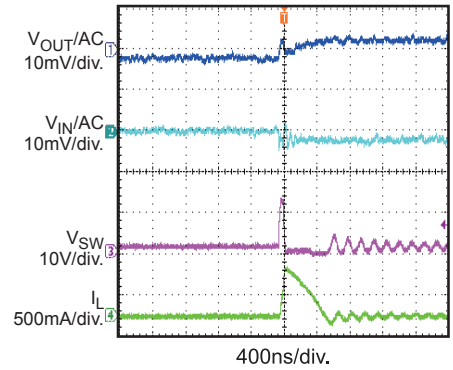

Load Transient Response
I_{OUT} = 4A to 8A

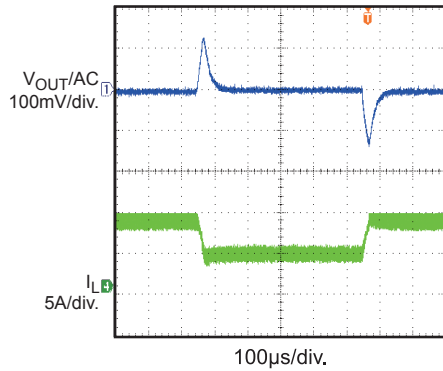

I²C Control Slew Rate
Slew Rate=16mV/μs, I_{OUT} = 0A, from 0.9V to 1.2V

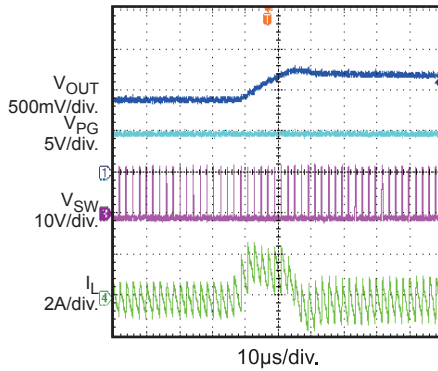

I²C Control Slew Rate
Slew Rate=16mV/μs, I_{OUT} = 0A, from 1.2V to 0.9V

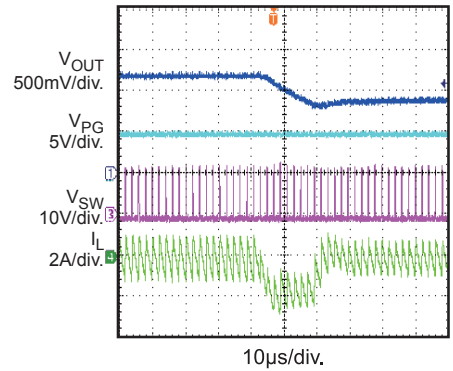

I²C Control Slew Rate
Slew Rate=16mV/μs, I_{OUT} = 5A, from 0.9V to 1.2V

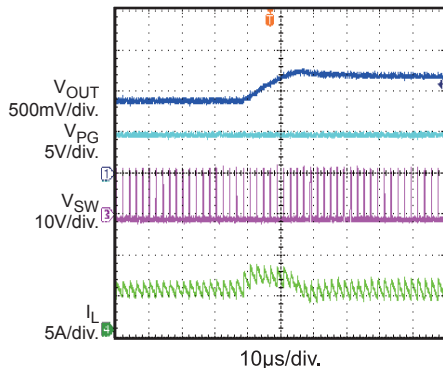

I²C Control Slew Rate
Slew Rate=16mV/μs, I_{OUT} = 5A, from 1.2V to 0.9V

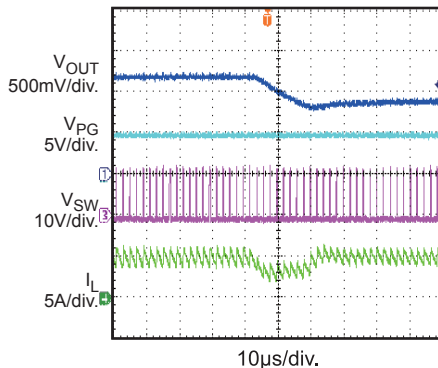

PRINTED CIRCUIT BOARD LAYER

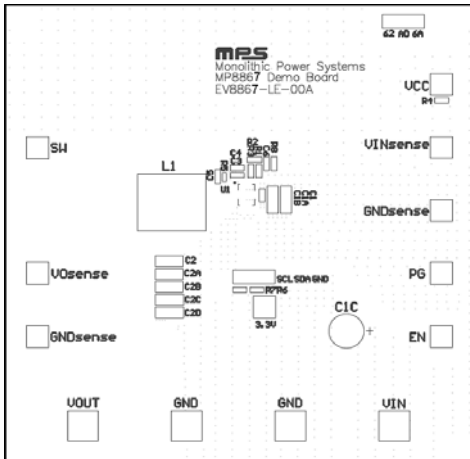

Figure 1: Top Silk Layer

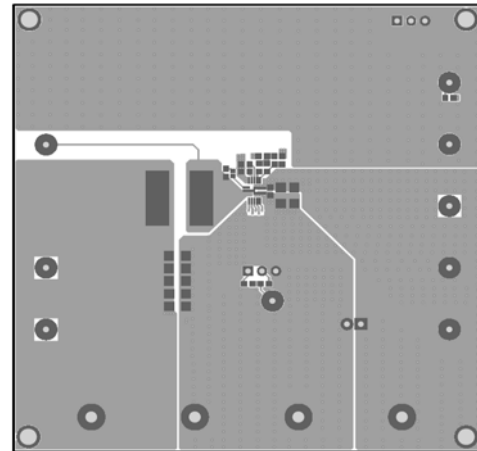

Figure 2: Top Layer

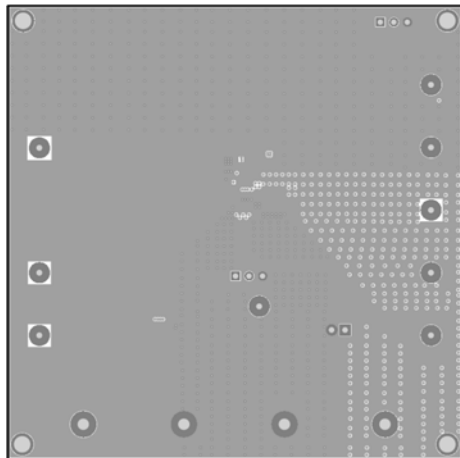

Figure 3: Inner 1 Layer

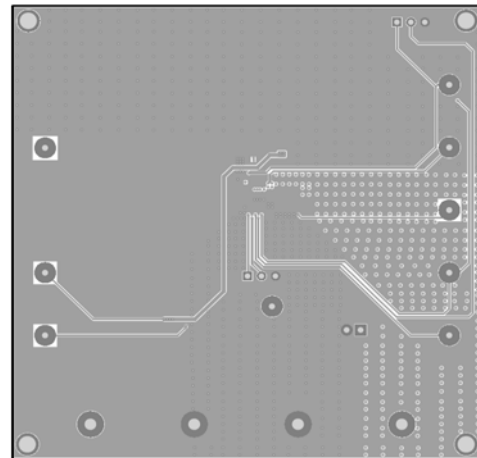

Figure 4: Inner 2 Layer

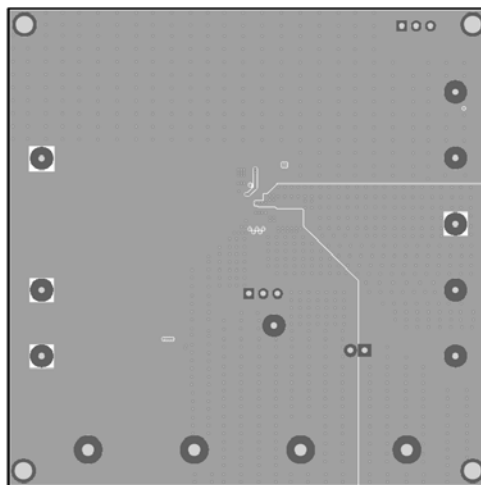

Figure 5: Bottom Layer

QUICK START GUIDE

1. Connect the positive and negative terminals of the load to the VOUT and GND pins, respectively.
2. Preset the power supply output between 4.5V and 17V, and then turn off the power supply.
3. Connect the positive and negative terminals of the power supply output to the VIN and GND pins, respectively.
4. Turn the power supply on. The board will automatically start up.
5. To use the Enable function, apply a digital input to the EN pin. Drive EN higher than 1.52V to turn on the regulator, or less than 1.02V to turn it off.
6. To program I²C function, connect SCL, SDA and GND to I²C start kit board. Connect I²C start kit board to computer and run MP8867 GUI software to program MP8867 I²C register.

NOTICE: The information in this document is subject to change without notice. Please contact MPS for current specifications. Users should warrant and guarantee that third party Intellectual Property rights are not infringed upon when integrating MPS products into any application. MPS will not assume any legal responsibility for any said applications.