

### DESCRIPTION

The EV8845C-C-02A evaluation Board is designed to demonstrate the capabilities of MP8845C. The MP8845C is a low voltage high switching frequency step-down switcher with I<sup>2</sup>C interface. It can support up to 5A load current over an input supply range from 2.7V to 6V with excellent load and line regulation.

Constant frequency hysteretic control mode provides extremely fast transient response and high efficiency. A 3.4Mbps I<sup>2</sup>C serial interface is used to adjust MP8845C output voltage from 0.6V to 1.45V in 6.69mV steps. Voltage slew rate, switching frequency are also selectable through the I<sup>2</sup>C interface. Fully protection features includes internal soft start, over current protection and over temperature protection.

MP8845C is available in WLCSP20-1.6mm×2mm package.

### ELECTRICAL SPECIFICATION

Parameter	Symbol	Value	Units
Input Voltage Range	V <sub>IN</sub>	2.7-6	V
Output Voltage	V <sub>OUT</sub>	1.1	V
Load Current	I <sub>OUT</sub>	5	A

### FEATURES

- 2.7V to 6V Input Voltage Range
- Up to 5A Load Current
- Internal 32mΩ High-Side, 17mΩ Low-Side Power MOSFETs
- Fixed Frequency Hysteretic Mode Control
- I<sup>2</sup>C Compatible Interface up to 3.4Mbps
- I<sup>2</sup>C Programmable Output Range from 0.6V to 1.45V in 6.69mV Steps
- Factory Adjustable Switching Frequency from 1MHz to 2.2MHz
- I<sup>2</sup>C Programmable Voltage Transition Slew Rate
- Internal Soft-Start
- Power Good Indicator
- Current Overload and Thermal Shutdown Protection
- Available in 20-ball WLCSP-1.6mmx2mm package

### APPLICATIONS

- Processor Core Supply
- Micro Converter

All MPS parts are lead-free and adhere to the RoHS directive. For MPS green status, please visit MPS website under Quality Assurance. "MPS" and "The Future of Analog IC Technology", are Registered Trademarks of Monolithic Power Systems, Inc.

### EV8845C-C-02A EVALUATION BOARD



Board Number	MPS IC Number
EV8845C-C-02A	MP8845CGC

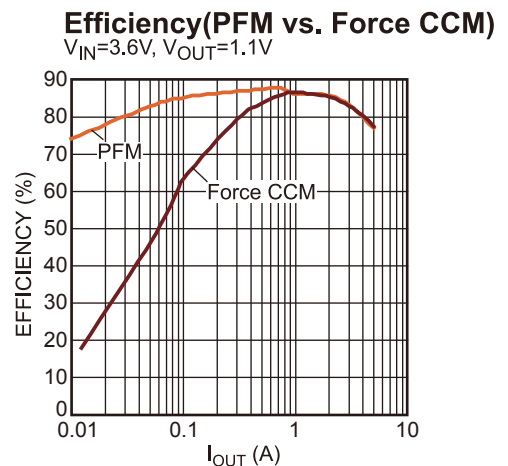

## EVALUATION BOARD SCHEMATIC

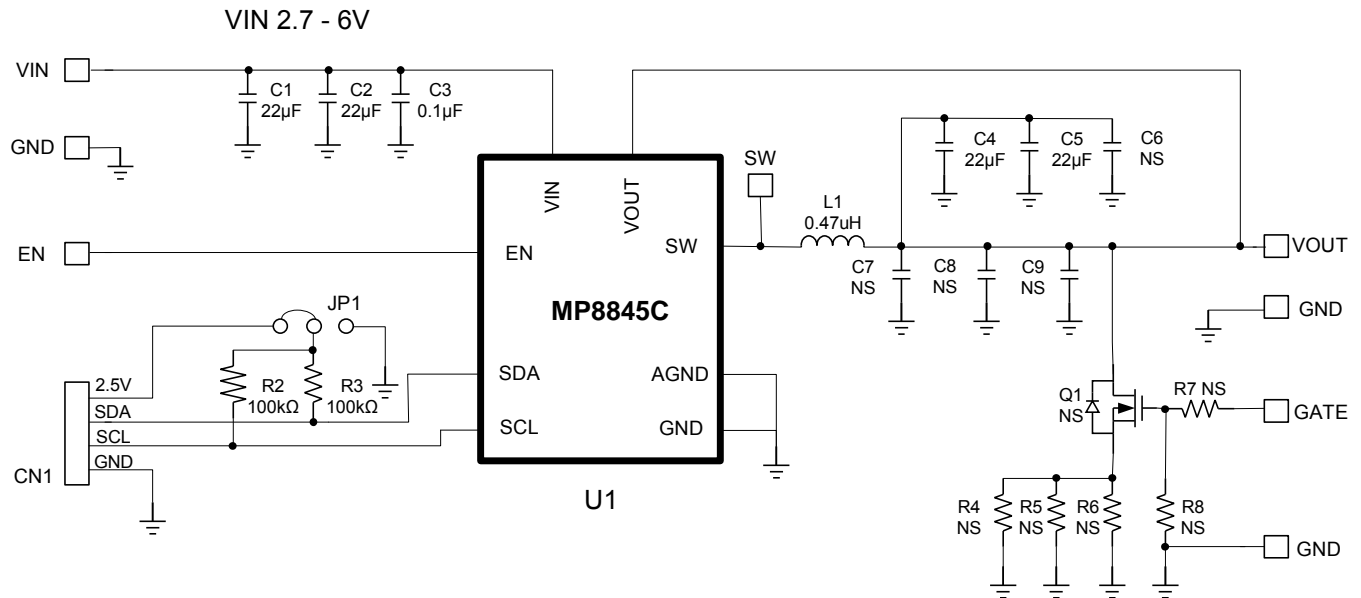

## EV8845C-C-02A BILL OF MATERIALS

Qty	RefDes	Value	Description	Package	Manufacturer	Manufacturer P/N
2	C1, C2,	22µF	Ceramic Cap., 10V, X5R	SM0805	muRata	GRM21BR61A226ME51L
1	C3	0.1µF	Ceramic Cap,16V,X7R	SM0603	muRata	GRM188R71C104KA01D
2	C4 C5	22µF	Ceramic Cap,6.3V,X5R	SM0805	muRata	GRM21BR60J226ME39L
0	C6 C7 C8 C9	NS				
2	R2 R3	100k	Film Res.,5%	SM0603	Any	
0	R4 R5 R6 R7 R8	NS				
0	Q1	NS				
1	L1	0.47µH	Inductor IR=6.8A,Isat=14.5A	SM 4.0X2.0mm	Würth	744 373 240 047
1	U1	MP8845C	Step Down Switcher With I2C	WLCSP20- 1.6mmx2mm	MPS	MP8845CGC

## EVB TEST RESULTS

Performance waveforms are tested on the evaluation board.

$V_{IN} = 5V$ ,  $V_{OUT} = 1.1V$ ,  $L = 0.47\mu H$ ,  $C_{OUT} = 2 \times 22$ ,  $T_A = 25^\circ C$ , unless otherwise noted.

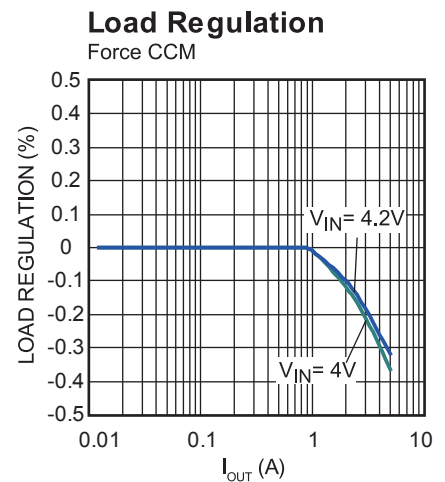
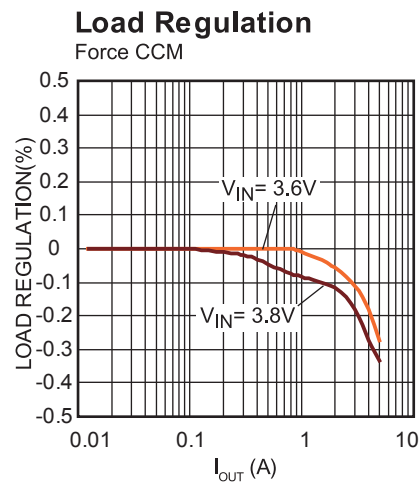
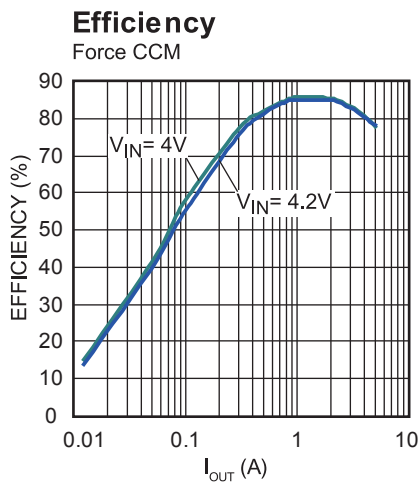
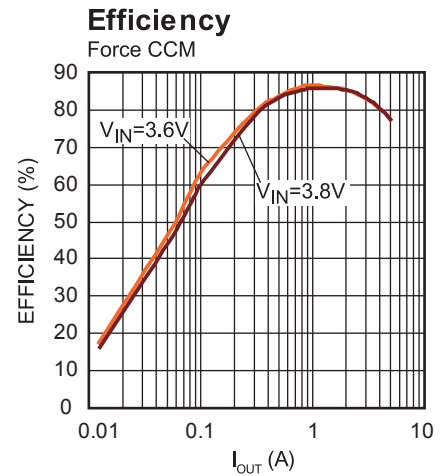
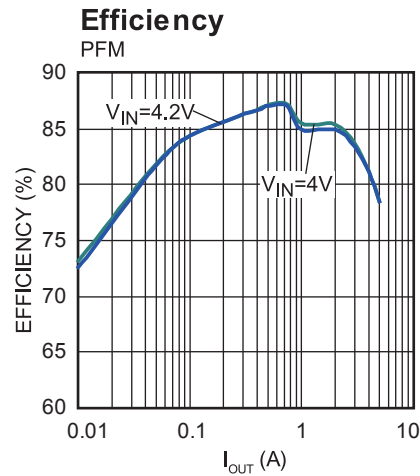
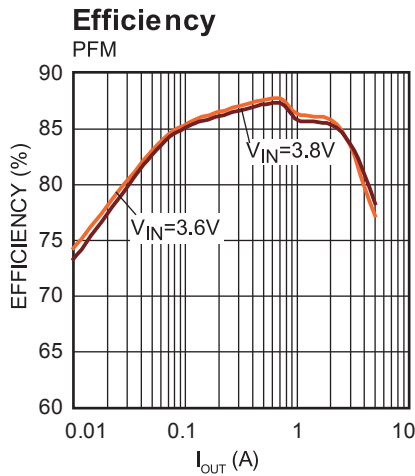

## EVB TEST RESULTS *(continued)*

Performance waveforms are tested on the evaluation board.

$V_{IN} = 5V$ ,  $V_{OUT} = 1.1V$ ,  $L = 0.47\mu H$ ,  $C_{OUT} = 2 \times 22$ , PFM,  $T_A = 25^\circ C$ , unless otherwise noted.

**Steady State**  
 $I_{OUT} = 0A$

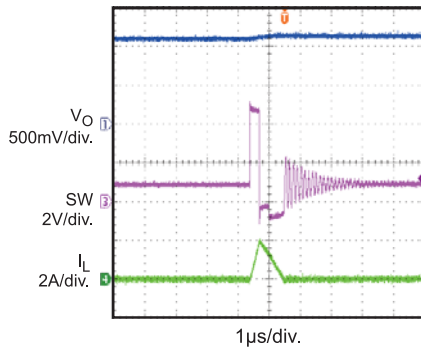

**Steady State**  
 $I_{OUT} = 2.5A$

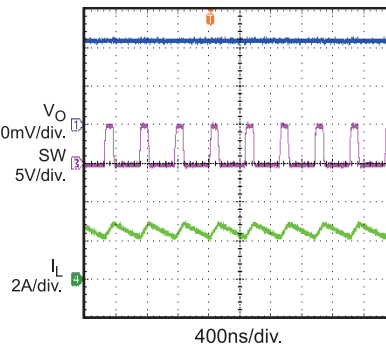

**Output ripple**  
 $I_{OUT} = 5A$

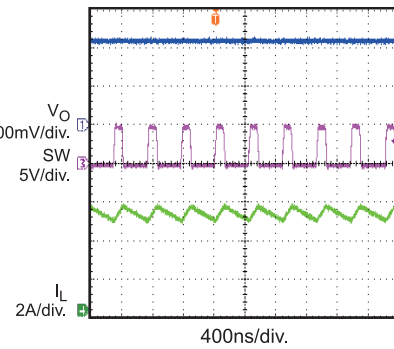

**Vin power up without load**  
 $I_{OUT} = 0A$

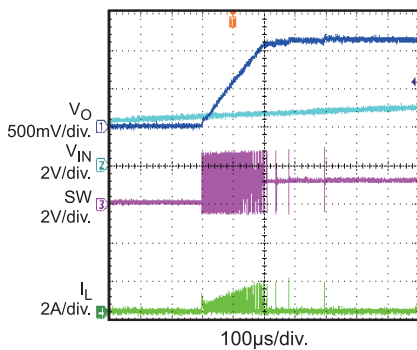

**Vin power up full load**  
 $I_{OUT} = 5A$

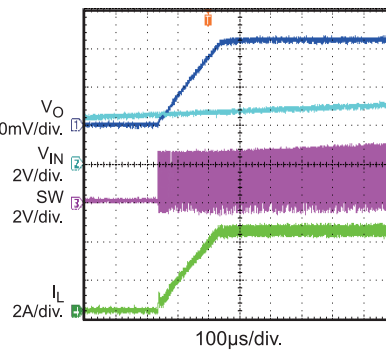

**Vin power down without load**  
 $I_{OUT} = 0A$

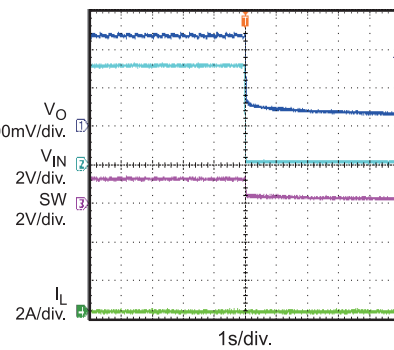

**Vin power down full load**  
 $I_{OUT} = 5A$

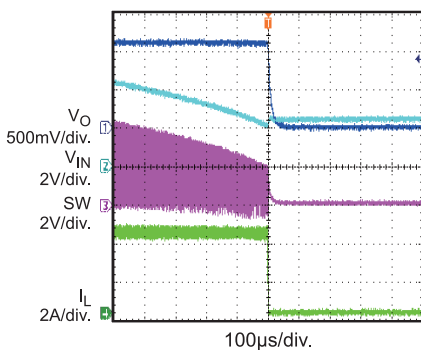

**EN on without load**  
 $I_{OUT} = 0A$

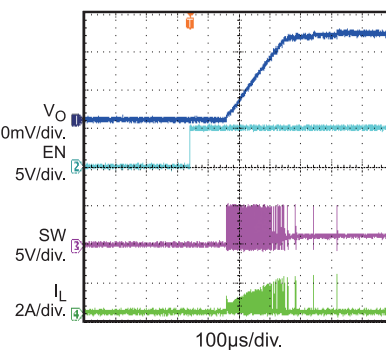

**EN on with full load**  
 $I_{OUT} = 5A$

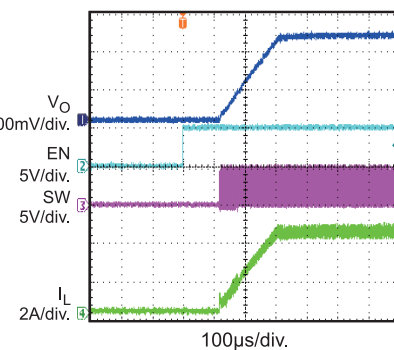

**EVB TEST RESULTS** *(continued)*

Performance waveforms are tested on the evaluation board.

$V_{IN} = 5V$ ,  $V_{OUT} = 1.1V$ ,  $L = 0.47\mu H$ ,  $C_{OUT} = 2 \times 22$ , PFM,  $T_A = 25^\circ C$ , unless otherwise noted.

**EN down without load**  
 $I_{OUT} = 0A$

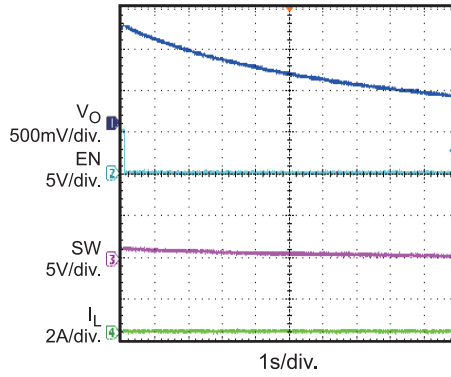

**EN down with full load**  
 $I_{OUT} = 5A$

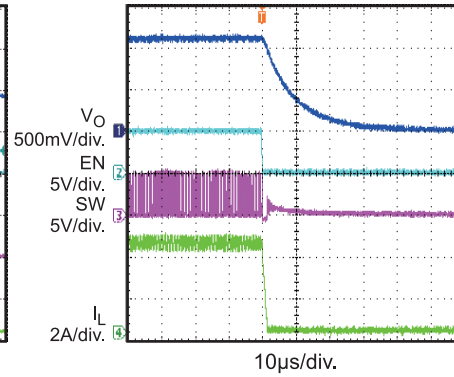

## PRINTED CIRCUIT BOARD LAYOUT

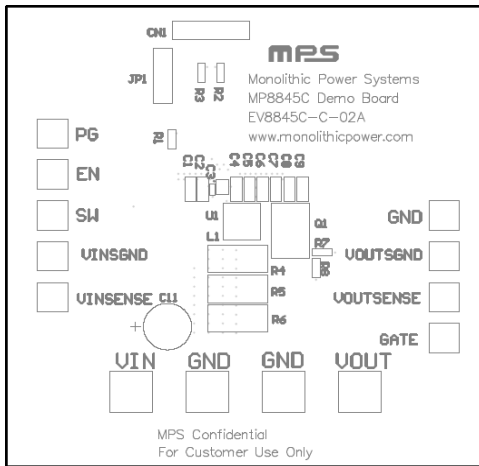

Figure 1—Top Silk Layer

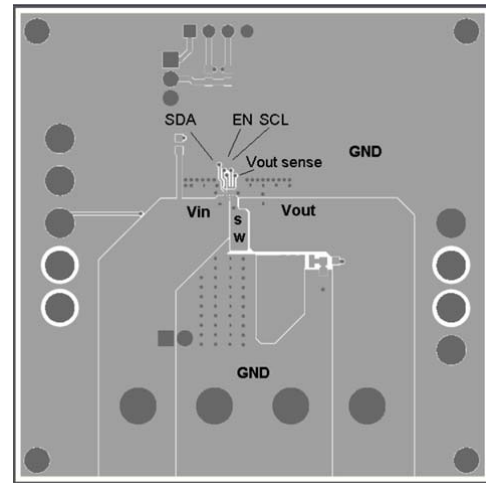

Figure 2—Top Layer

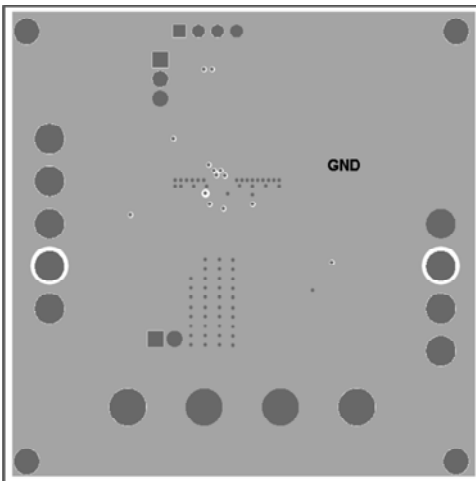

Figure 3—Inner 1 Layer

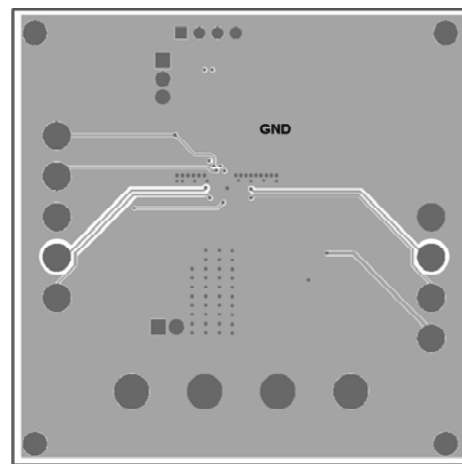

Figure 4—Inner 2 Layer

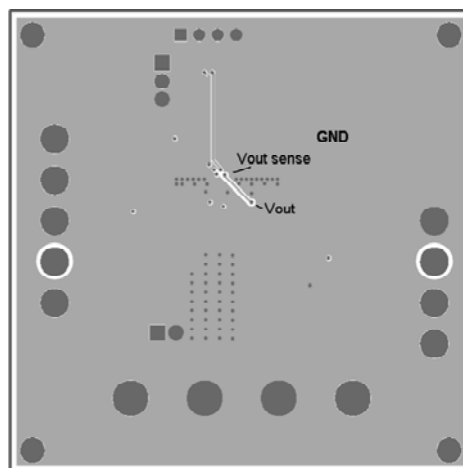

Figure 5—Bottom Layer

## QUICK START GUIDE

1. Install MP8845C software showed in figure 6(a) and figure 6(b). You can get the software from factory.



(a) MP8845 GUI



(b) The software to load the program

Figure 6

2. Use three wires to get the SDA, SCL and GND signals from the I<sup>2</sup>C interface board, and then connect the board to EV8845C-C-02A by the three wires, figure 7 shows the connecting method.

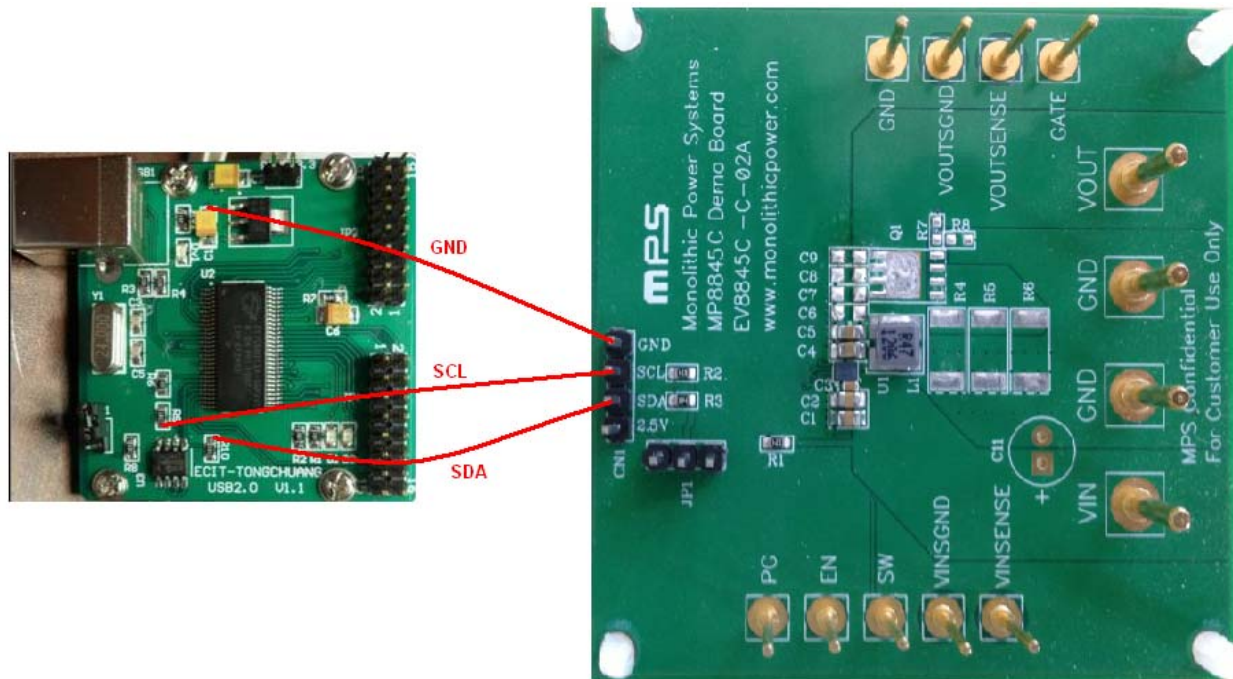
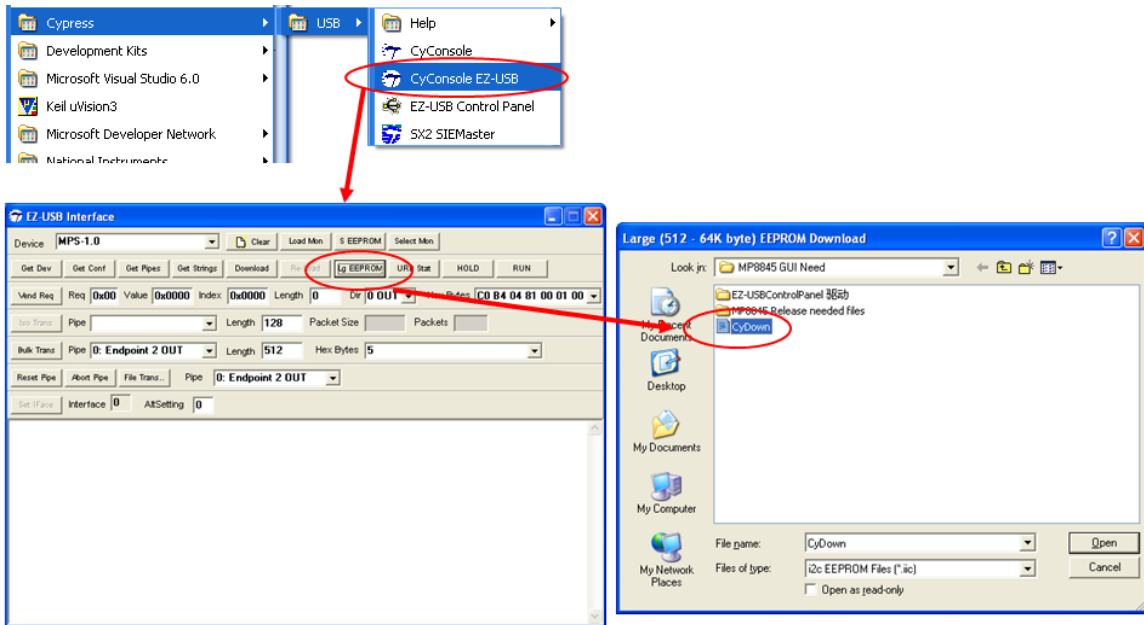

Figure 7—I2C interface board connecting method

3. Connect I<sup>2</sup>C interface board to computer, and then load the hardware program to the board. Figure 8 shows the loading process.
4. Connect the positive and negative terminals of the load to VOUT and GND pins of EV8845C-C-02A board, respectively.
5. Preset the power supply output between 2.7V and 6V, and then turn off the power supply.
6. Connect the positive and negative terminals of the power supply output to the VIN and GND pins of EV8845C-C-02A board, respectively.
7. Turn the power supply on. Drive EN higher than 1.8V to turn on the EV8845C-C-02A board or less than 0.4V to turn it off.
8. Run MP8845C software, fill slave address 1C, and check address, when it shows VALID and the color turns to green, I2C GUI interface can achieve control of MP8845C. MP8845C I2C control interface is showed in figure 9.





**Figure 8—loading hardware program process**

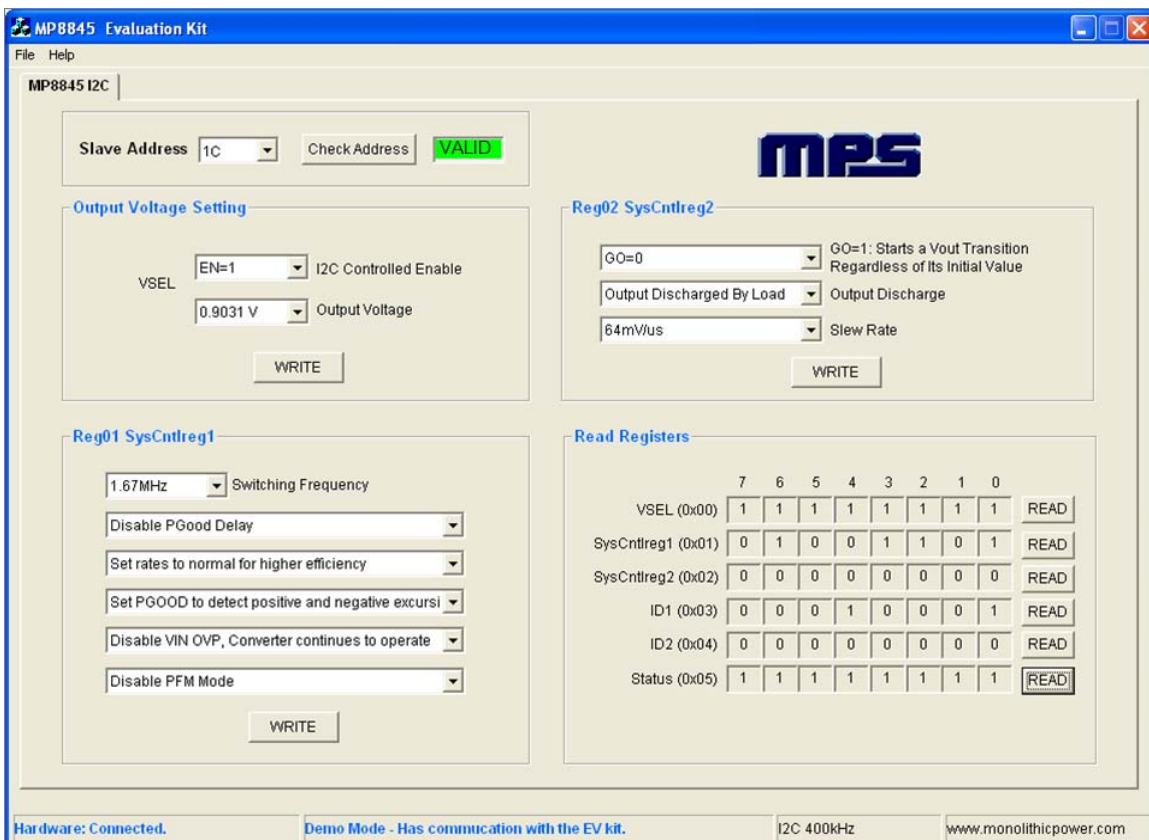

**Figure 9—MP8845C control interface**



## LAYOUT RECOMMENDATION OF MP8845C

Proper layout of the switching power supplies is very important, and sometimes critical to make it work properly. Especially, for the high switching frequency converter, if the layout is not carefully done, the regulator could show poor line or load regulation, and stability issues.

**NOTICE:** The information in this document is subject to change without notice. Please contact MPS for current specifications. Users should warrant and guarantee that third party Intellectual Property rights are not infringed upon when integrating MPS products into any application. MPS will not assume any legal responsibility for any said applications.