



The Future of Analog IC Technology®

EV8845-C-02A

5A High Efficient Synchronous Step-Down Switcher with I²C Interface

DESCRIPTION

The EV8845-C-02A is used for demonstrating the performance of MPS's MP8845. MP8845 is a highly integrated and high frequency synchronous step-down switcher with I²C control interface. It is optimized to support up to 5A load current over an input supply range from 2.7V to 6V with excellent load and line regulation.

Constant frequency hysteretic control mode provides extremely fast transient response and high efficiency. The output voltage level can be controlled, on-the fly through a 3.4Mbps I²C serial interface. Voltage range can be adjusted from 0.6V to 1.1V in 3.9mV steps. Voltage slew rate, switching frequency and power savings mode are also selectable through the I²C interface. Fully protection features includes internal soft start, over current protection and over temperature protection.

MP8845 is available in WLCSP20-1.6mmx2mm package.

ELECTRICAL SPECIFICATION

Parameter	Symbol	Value	Units
Input Voltage	V _{IN}	2.7– 6	V
Output Voltage	V _{OUT}	0.9	V
Output Current	I _{OUT}	5	A

FEATURES

- Wide 2.7V to 6V Operating Input Range
- Up to 5A Load Current
- Internal 28mΩ High-Side, 17mΩ Low-Side Power MOSFETs
- Fixed Frequency Hysteretic Mode Control
- I²C Compatible Interface up to 3.4Mbps
- I²C Programmable Output Range from 0.6V to 1.1V in 3.9mV Steps
- Factory Adjustable Switching Frequency from 1MHz to 2.2MHz
- I²C Programmable Voltage Transition Slew Rate
- Power Saving Mode Selectable via I²C
- Internal Soft-Start
- Power Good Indicator
- Current Overload and Thermal Shutdown Protection
- Available in 20-ball WLCSP-1.6mmx2mm package

APPLICATIONS

- Processor Core Supply
- Micro Converter

All MPS parts are lead-free and adhere to the RoHS directive. For MPS green status, please visit MPS website under Products, Quality Assurance page. "MPS" and "The Future of Analog IC Technology" are registered trademarks of Monolithic Power Systems, Inc.

EV8845-C-02A EVALUATION BOARD



Board Number	MPS IC Number
EV8845-C-02A	MP8845GC

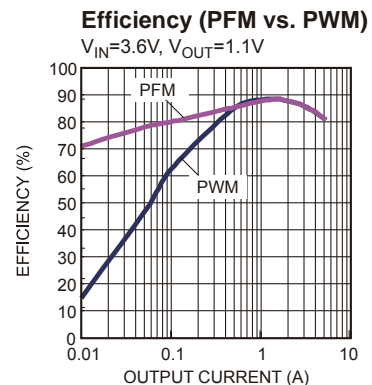

EVALUATION BOARD SCHEMATIC

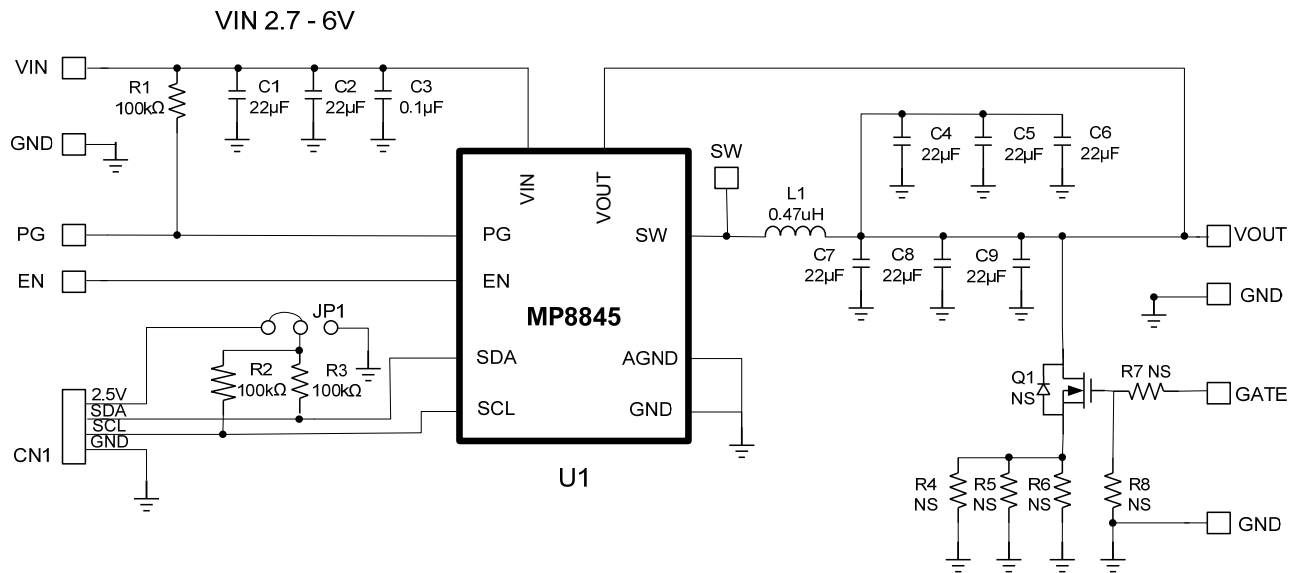

EV8845-C-02A BILL OF MATERIALS

Qty	RefDes	Value	Description	Package	Manufacturer	Manufacturer P/N
2	C1, C2,	22μF	Ceramic Cap., 10V, X5R	SM0805	muRata	GRM21BR61A226ME51L
1	C3	0.1μF	Ceramic Cap, 16V, X7R	SM0603	muRata	GRM188R71C104KA01D
6	C4 C5 C6 C7 C8 C9	22μF	Ceramic Cap, 6.3V, X5R	SM0805	muRata	GRM21BR60J226ME39L
3	R1 R2 R3	100k	Film Res., 5%	SM0603	Any	
0	R4 R5 R6 R7 R8	NS				
0	Q1	NS				
1	L1	0.47μH	Inductor IR=6.8A, Isat=14.5A	SM 4.0X2.0mm	Würth	744 373 240 047
1	U1	MP8845	Step Down Switcher With I2C	WLCSP20- 1.6mmx2mm	MPS	MP8845GC

EVB TEST RESULTS

Performance waveforms are tested on the evaluation board.

$V_{IN} = 5V$, $V_{OUT} = 0.9V$, $L = 0.47\mu H$, $T_A = 25^\circ C$, unless otherwise noted.

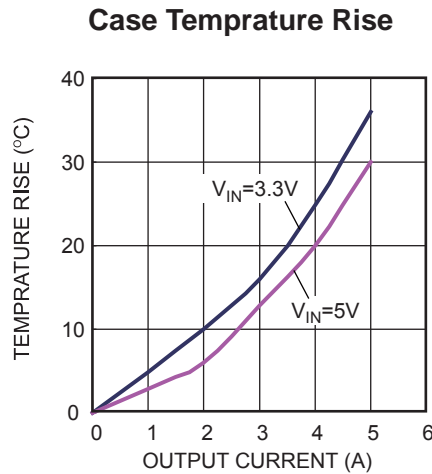
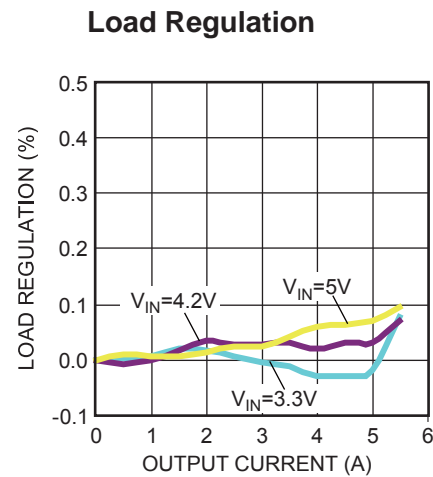
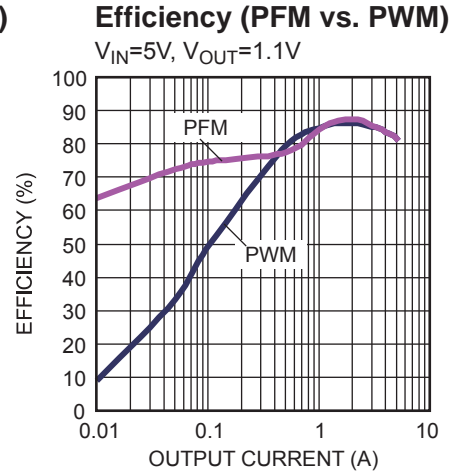
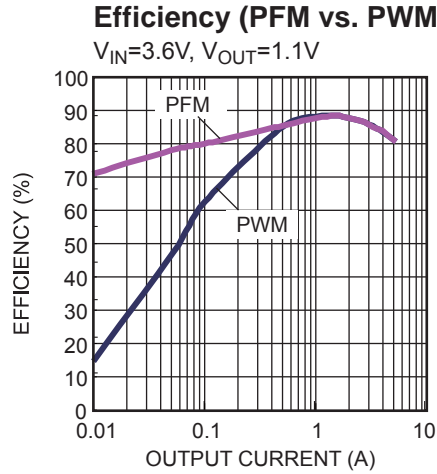
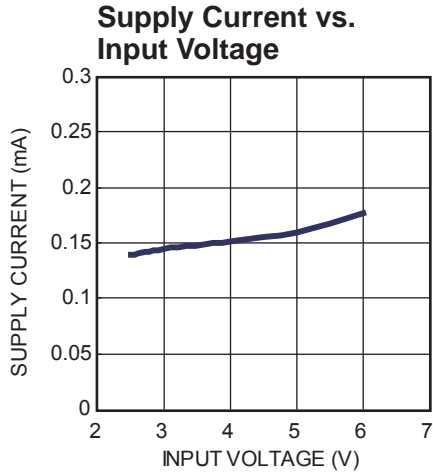

EVB TEST RESULTS (continued)

Performance waveforms are tested on the evaluation board.

 $V_{IN} = 5V$, $V_{OUT} = 0.9V$, $L = 0.47\mu H$, $T_A = 25^\circ C$, unless otherwise noted.

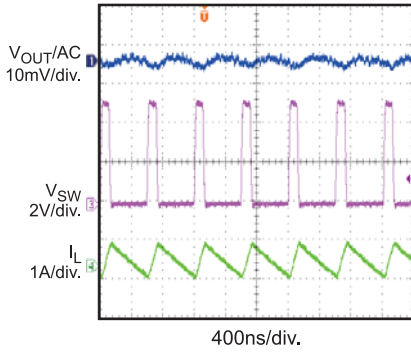
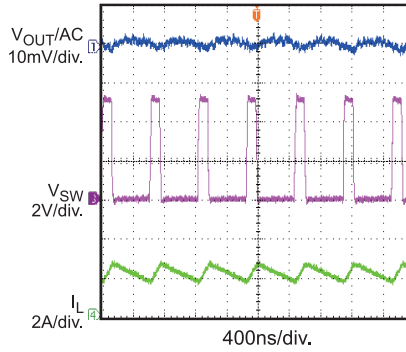
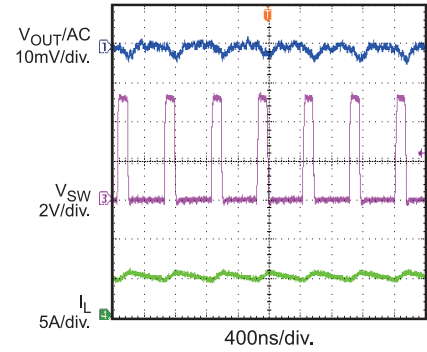
Output Ripple
 $I_{OUT} = 0A$

Output Ripple
 $I_{OUT} = 2A$

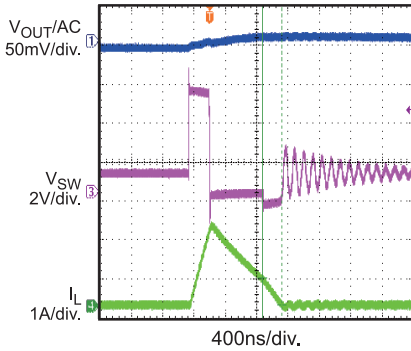
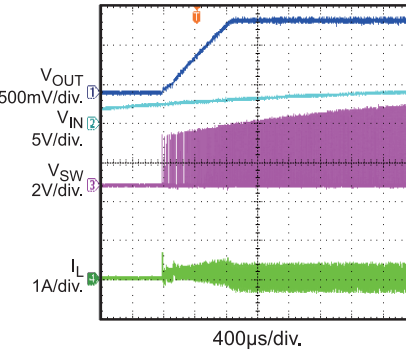
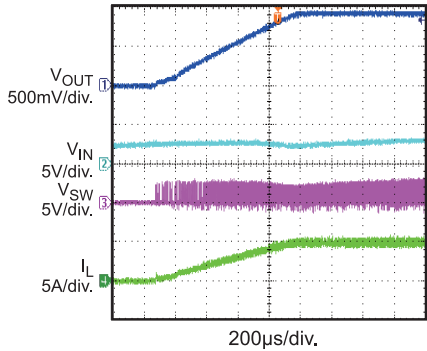
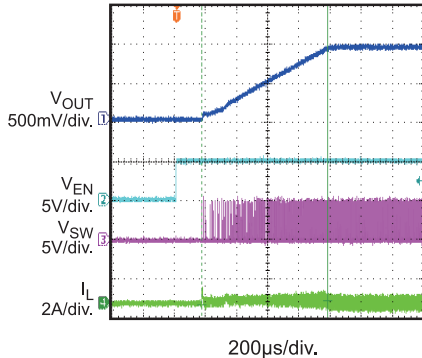
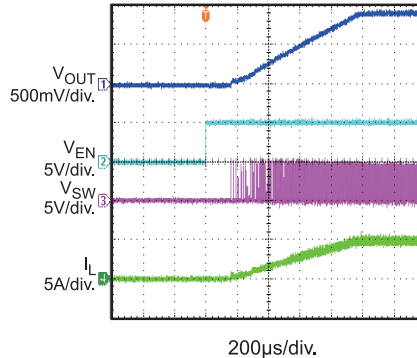
Output Ripple
 $I_{OUT} = 5A$

Output Ripple

PFM Mode

VIN Power Up without Load
 $I_{OUT} = 0A$

VIN Power Up with 5A Load
 $I_{OUT} = 5A$

EN Start Up without Load
 $I_{OUT} = 0A$

EN Start Up with 5A Load
 $I_{OUT} = 5A$

PRINTED CIRCUIT BOARD LAYER

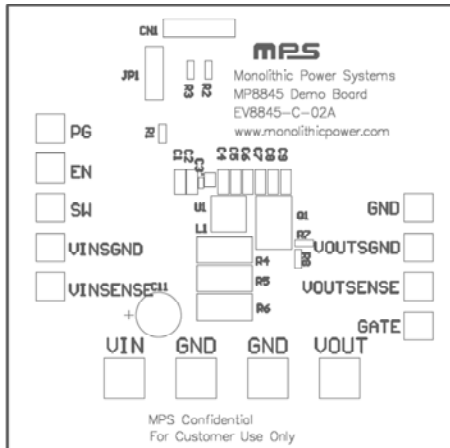

Figure 1: Top Silk Layer

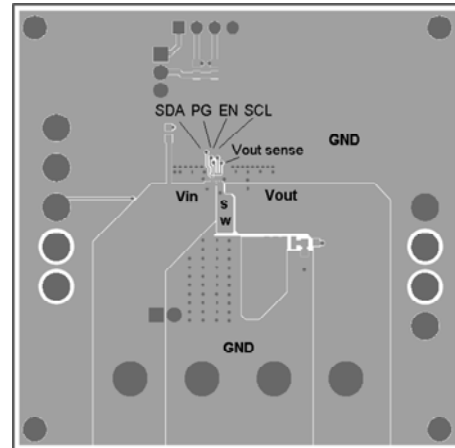

Figure 2: Top Layer

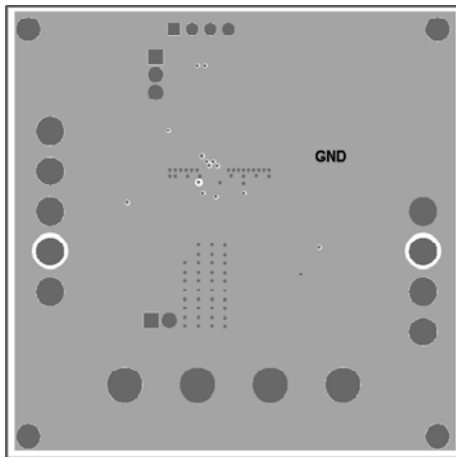

Figure 3: Inner 1 Layer

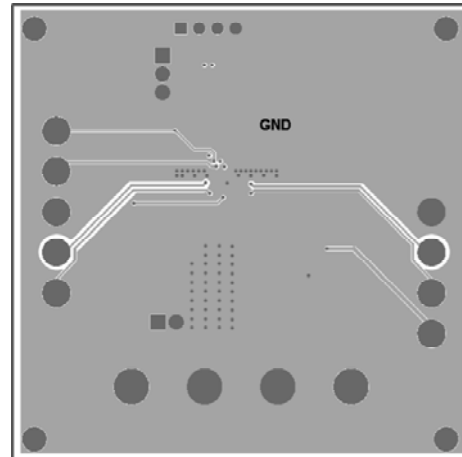

Figure 4: Inner 2 Layer

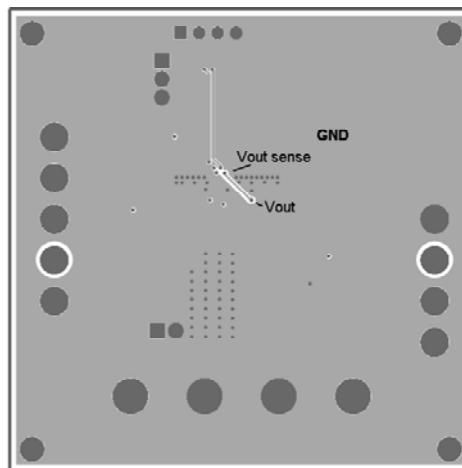

Figure 5: Bottom Layer

QUICK START GUIDE

1. Connect the positive and negative terminals of the load to the VOUT and GND pins, respectively.
2. Preset the power supply output between 2.7V and 6V, and then turn off the power supply.
3. Connect the positive and negative terminals of the power supply output to the VIN and GND pins, respectively.
4. Turn the power supply on. The board will automatically start up.

LAYOUT RECOMMENDATION OF MP8845

Proper layout of the switching power supplies is very important, and sometimes critical to make it work properly. Especially, for the high switching frequency converter, if the layout is not carefully done, the regulator could show poor line or load regulation, stability issues.

NOTICE: The information in this document is subject to change without notice. Please contact MPS for current specifications. Users should warrant and guarantee that third party Intellectual Property rights are not infringed upon when integrating MPS products into any application. MPS will not assume any legal responsibility for any said applications.