

EVALUATION BOARD SCHEMATIC

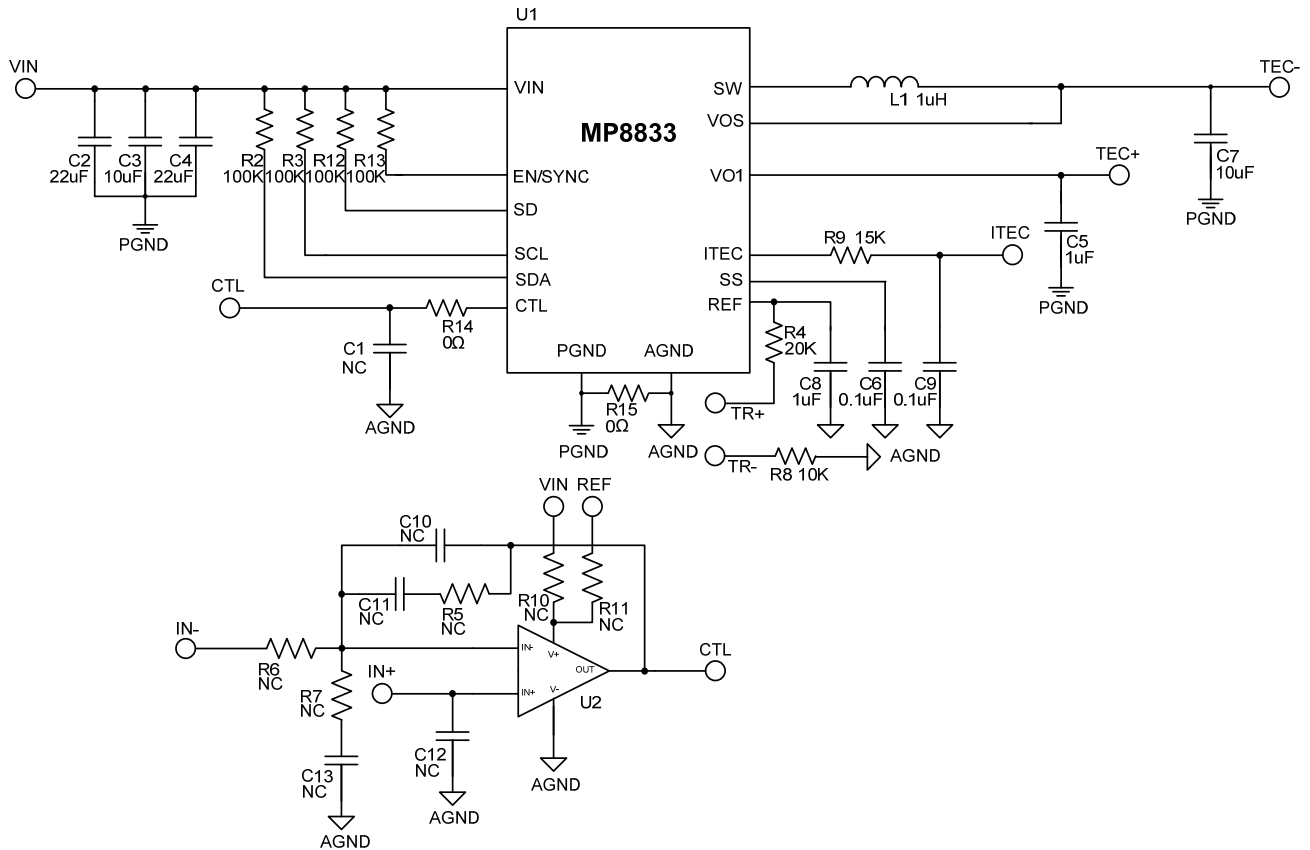

Figure1—Typical Application Circuit for MP8833GD

EV8833-D-01B BILL OF MATERIALS

Qty	RefDes	Value	Description	Package	Manufacturer	Manufacturer P/N
2	C6, C9	100nF	Ceramic Cap.,25V,X7R	0603	Murata	GRM188R71E104KA01D
2	C3, C7	10uF	Ceramic Cap.,25V,X7S	0805	Murata	GRM21BC71E106KE11L
2	C2, C4	22uF	Ceramic Cap.,25V,X5R	0805	Murata	GRM21BR61E226ME44L
2	C5, C8	1uF	Ceramic Cap.,25V,X7R	0603	Murata	GRM188R71E105KA12D
4	R2, R3, R12, R13	100k	Film Res,1%,0603,100K	0603	YAGEO	RC0603FR-07100KL
1	R9	15k	Film Res,1%,0603,15K	0603	YAGEO	RC0603FR-0715KL
2	R14, R15	0R	Film Res,1%,0603,0R	0603	YAGEO	RC0603FR-070RL
1	L1	1uH	Inductor,RDC=27mOhm,Isat=9 .0A	4020	WE	74437324010
1	R4	20k	Film Res,1%,0603,20K	0603	YAGEO	RC0603FR-0720KL
1	R8	10k	Film Res,1%,0603,10K	0603	YAGEO	RC0603FR-0710KL
1	U1	MP8833	1.5A Thermoelectric Cooler Controller	QFN-16	MPS	MP8833GD
0	C1, C10, C11, C12, C13	NC				
0	R5, R6, R7, R10, R11	NC				
0	U2	NC				

TYPICAL PERFORMANCE CHARACTERISTICS(continued)

$V_{IN} = 3.3V$, $L = 1\mu H$, $C_{OUT} = 10\mu F$, $T_A = +25^\circ C$, unless otherwise noted.

VIN Start-Up

$V_{IN} = 3.3V$, Cooling, $I_{OUT} = 0A$

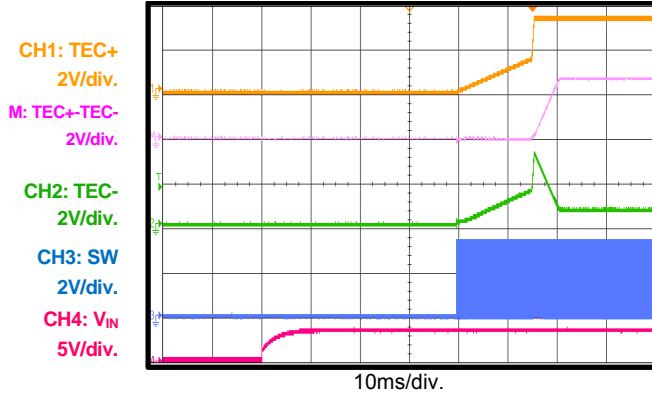

VIN Start-Up

$V_{IN} = 3.3V$, Heating, $I_{OUT} = 0A$

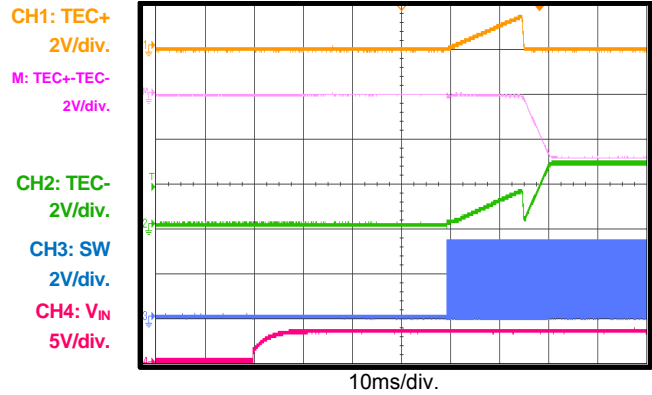

VIN Shutdown

$V_{IN} = 3.3V$, Cooling, $I_{OUT} = 0A$

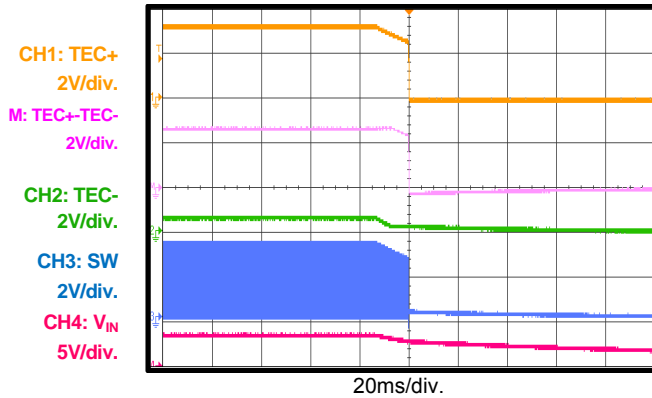

EN Start-Up

$V_{IN} = 3.3V$, Cooling, $I_{OUT} = 0A$

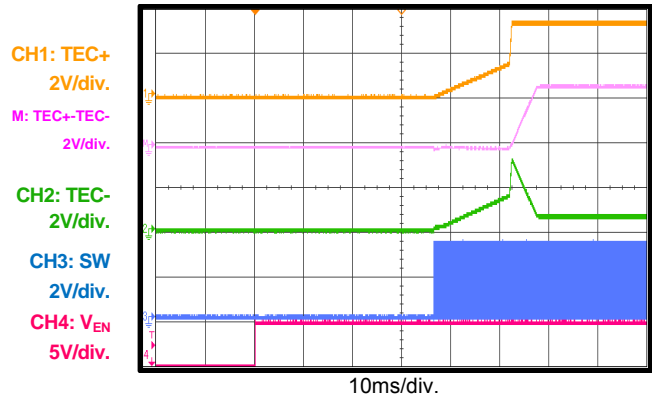

EN Shutdown

$V_{IN} = 3.3V$, Cooling, $I_{OUT} = 0A$

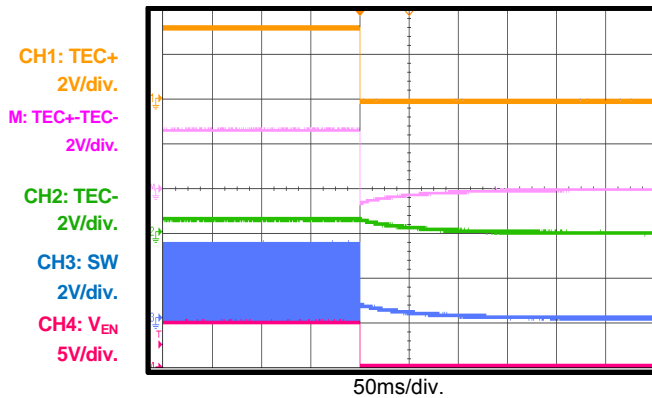

SD Start-Up

$V_{IN} = 3.3V$, Cooling, $I_{OUT} = 0A$

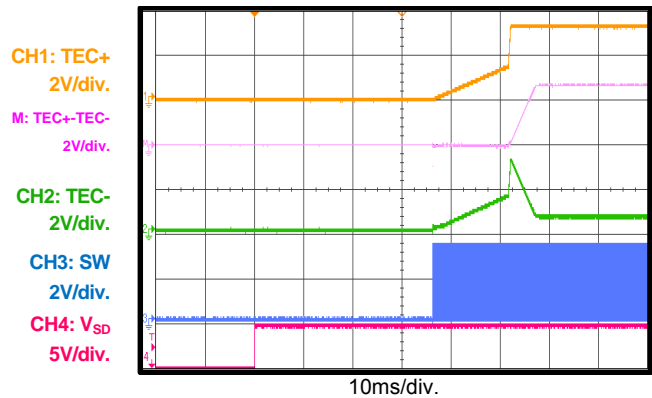

TYPICAL PERFORMANCE CHARACTERISTICS(continued)

$V_{IN} = 3.3V$, $L = 1\mu H$, $C_{OUT} = 10\mu F$, $T_A = +25^\circ C$, unless otherwise noted.

SD Shutdown

$V_{IN} = 3.3V$, Cooling, $I_{OUT} = 0A$

CH1: TEC+
2V/div.
M: TEC+ - TEC-
2V/div.
CH2: TEC-
2V/div.
CH3: SW
2V/div.
CH4: V_{SD}
5V/div.

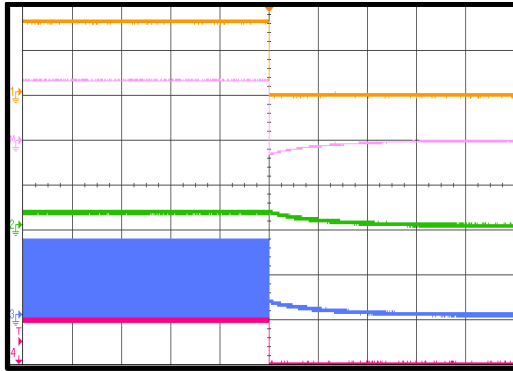

CTL Transient

$V_{IN} = 3.3V$, $I_{OUT} = 0A$

CH1: TEC+
2V/div.
M: TEC+ - TEC-
2V/div.
CH2: TEC-
2V/div.
CH3: SW
2V/div.
CH4: V_{CTL}
2V/div.

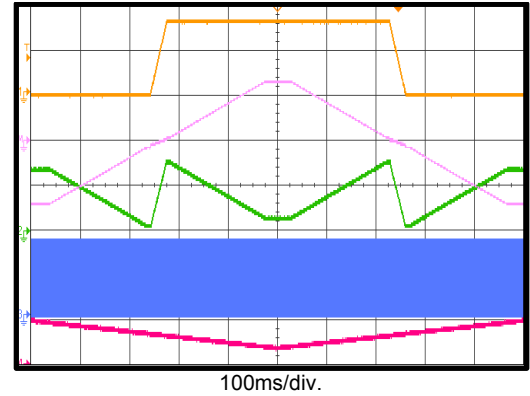

PRINTED CIRCUIT BOARD LAYOUT

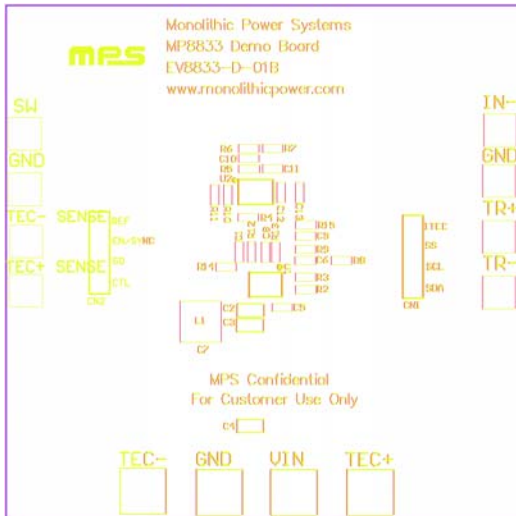

Figure 2—Top Silk Layer

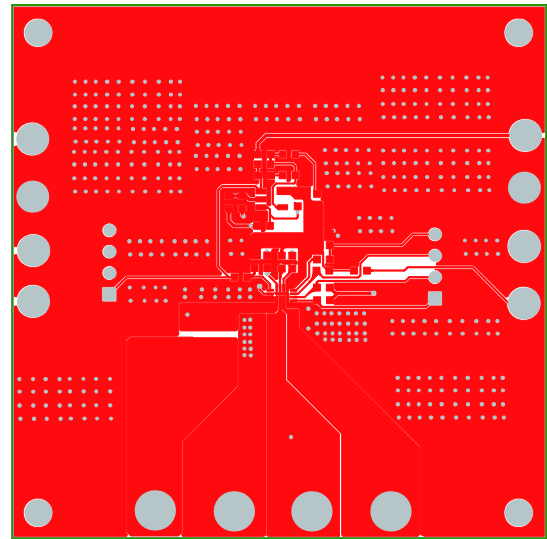

Figure 3—Top Layer

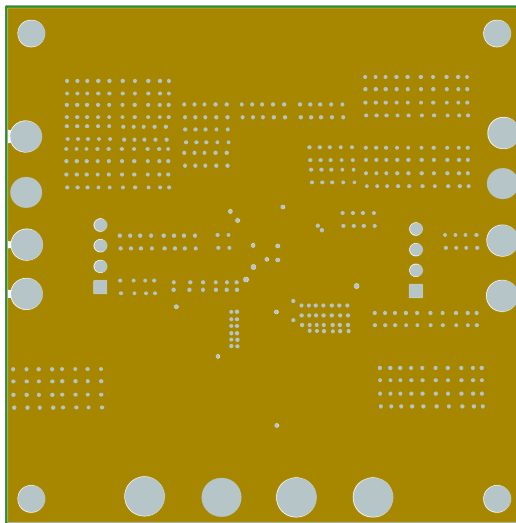

Figure 4—Middle Layer1

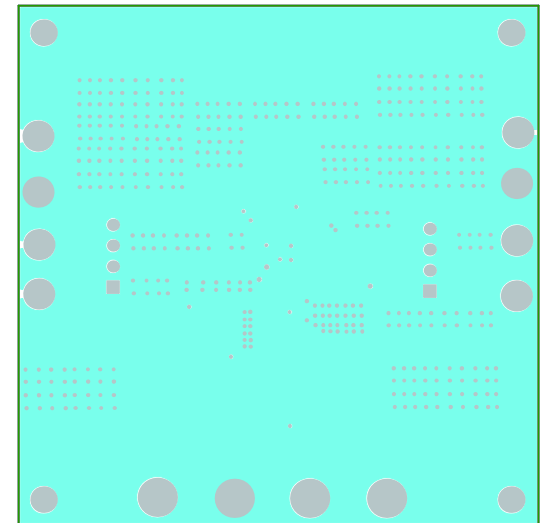

Figure 5—Middle Layer2

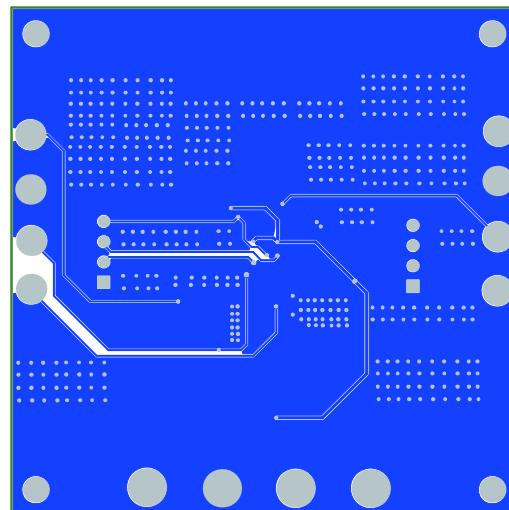

Figure 6—Bottom Layer

QUICK START GUIDE

EV8833-D-01B can combine with EV8833-Base-00A to get a close loop system, please refer EV8833-Base-Board datasheet and MP8833 datasheet for more details.

EV8833-D-01B can also work in open loop, please follow below steps to setup:

1. Connect a TEC or an R-load to the TEC+ and TEC- pins, respectively.
2. Preset the power supply output between 2.7V and 5.5V, and then turn off the power supply.
3. Connect the positive and negative terminals of the power supply output to the VIN and GND pins, respectively.
4. Turn the power supply on. The board will automatically start up.
5. Connect the CTL pin to a voltage within 0V to 5V to adjust the TEC voltage and direction.

NOTICE: The information in this document is subject to change without notice. Users should warrant and guarantee that third party Intellectual Property rights are not infringed upon when integrating MPS products into any application. MPS will not assume any legal responsibility for any said applications.