

DESCRIPTION

The EV8765-Q-00A is an evaluation board for the MP8765GQ, a high efficiency monolithic synchronous step-down converter.

The Evaluation Board can deliver 6A continuous load current from a 5V to 24V input with excellent load and line regulation.

Constant-On-Time (COT) control mode provides fast transient response and eases loop stabilization.

The Evaluation Board can be turned on or shut down via a remote ON/OFF input that is reference to ground. This input is compatible with popular logic devices.

ELECTRICAL SPECIFICATION

Parameter	Symbol	Value	Units
Input Voltage	V_{IN}	5 – 24	V
Output Voltage	V_{OUT}	1.05	V
Output Current	I_{OUT}	6	A
Switching Frequency	f_{SW}	500	kHz

FEATURES

- Wide 5V to 24V Operating Input Range
- 6A Continuous Output Current
- PFM/PWM Mode Selectable
- Low $R_{DS(ON)}$ Internal Power MOSFETs
- Proprietary Switching Loss Reduction Technique
- 1% Reference Voltage
- Internal Soft Start
- Output Discharge
- 500kHz Switching Frequency
- OCP, OVP, UVP Protection and Thermal Shutdown
- Available in a QFN3x3 package

APPLICATIONS

- Laptop Computer
- Tablet PC
- Networking Systems
- Personal Video Recorders
- Flat Panel Television and Monitors
- Distributed Power Systems

All MPS parts are lead-free and adhere to the RoHS directive. For MPS green status, please visit MPS website under Products, Quality Assurance page.

"MPS" and "The Future of Analog IC Technology", are Registered Trademarks of Monolithic Power Systems, Inc.

EV8765-Q-00A EVALUATION BOARD



(L x W x H) 8.55cm x 8.55cm x 1.6cm

Board Number	MPS IC Number
EV8765-Q-00A	MP8765GQ

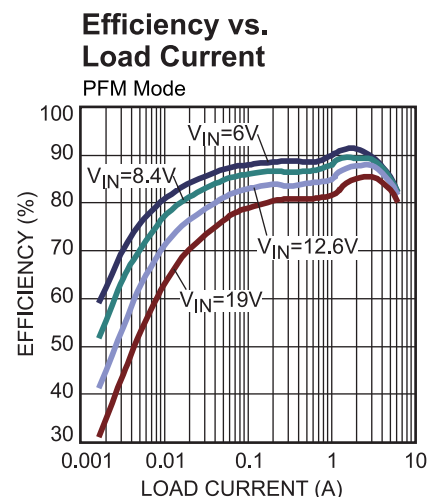

EVALUATION BOARD SCHEMATIC

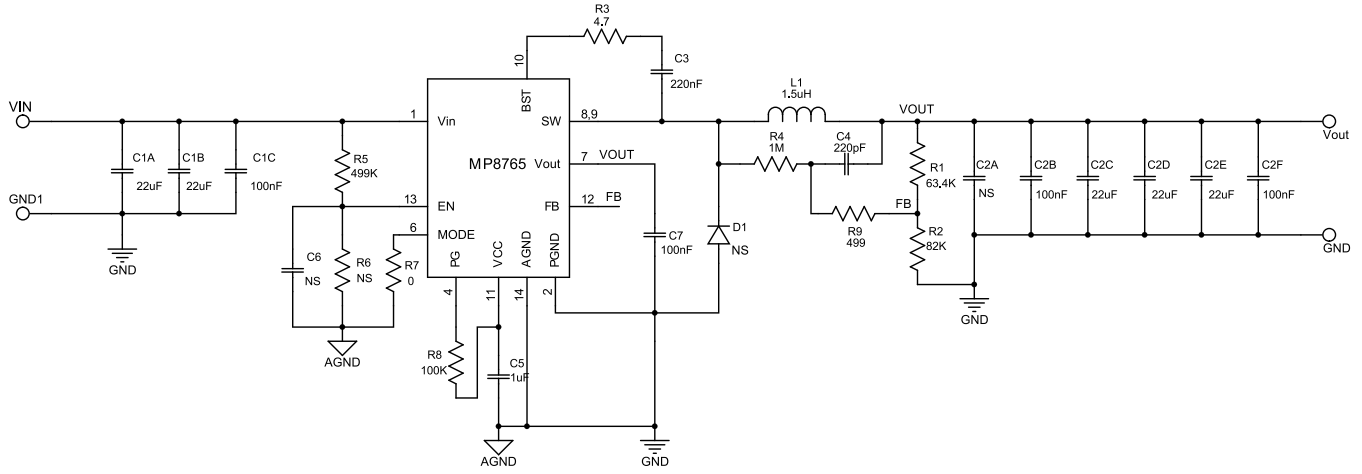

EV8765-Q-00A BILL OF MATERIALS

Qty.	Ref	Value	Description	Package	Manufacture	Manufacture_PN
2	C1A, C1B	22 μ F	Ceramic Capacitor; 25V;X5R;1210;	1210	muRata	GRM32ER61E226KE15L
1	C1C	100nF	Ceramic Capacitor; 50V;X7R;0603;	0603	muRata	GRM188R71H104KA93D
0	C2A	NS		POSCAP		
3	C2B, C2F, C7	100nF	Ceramic Capacitor; 16V;X7R;0603;	0603	muRata	GRM188R71C104KA01D
3	C2C, C2D, C2E	22 μ F	Ceramic Capacitor; 6.3V;X5R;1206	1206	muRata	GRM31CR60J226KE19
1	C3	220nF	Ceramic Capacitor; 16V;X7R;0603;	0603	muRata	GRM188R71C224KA01
1	C4	220pF	Ceramic Capacitor; 50V;X7R;0603;	0603	muRata	GRM188R71H221KA01D
1	C5	1 μ F	Ceramic Capacitor; 6.3V;X5R;0603	0603	muRata	GRM188R60J105KA01D
0	C6	NS		0603		
0	CN_OUT	NS	Connector			
0	D1	NS				
1	L1	1.5 μ H	Inductor;1.5 μ H;6.6m Ω ; 14A	SMD	Würth	744311150
1	R1	63.4k	Film Resistor;1%;	0603	Yageo	RC0603FR-0763K4L
1	R2	82k	Film Resistor;1%	0603	Yageo	RC0603FR-0782KL
1	R3	4.7	Film Resistor;5%;	0603	Yageo	RC0603JR-074R7L
1	R4	1M	Film Resistor;5%	0603	Any	
1	R5	499k	Film Resistor;1%;	0603	Yageo	RC0603FR-07499KL
0	R6	NS		0603		
1	R7	0	Film Resistor;5%	0603	Any	
1	R8	100k	Film Resistor;1%;	0603	Yageo	RC0603FR-07100KL
1	R9	499	Film Resistor;1%;	0603	Yageo	RC0603FR-07499RL
1	U1		Step down converter	QFN 3 \times 3	MPS	MP8765GQ

EVB TEST RESULTS

Performance waveforms are tested on the EV8765-Q-00A.

$V_{IN} = 12V$, $V_{OUT} = 1.05V$, $L = 1.5\mu H$, PFM mode, $T_A = 25^\circ C$, unless otherwise noted.

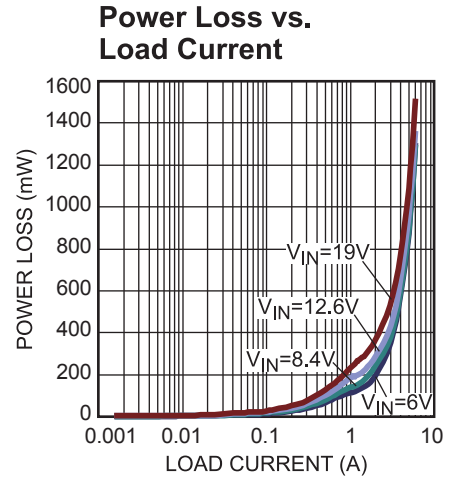
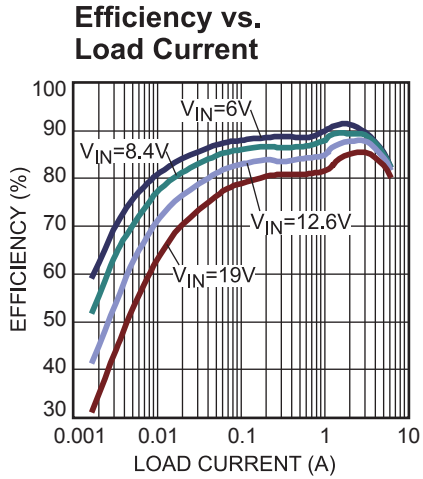

EV8 TEST RESULTS (continued)

Performance waveforms are tested on the EV8765-Q-00A.

 $V_{IN}=12V$, $V_{OUT}=1.05V$, $L=1.5\mu H$, PFM mode, $T_J=+25^\circ C$, unless otherwise noted.

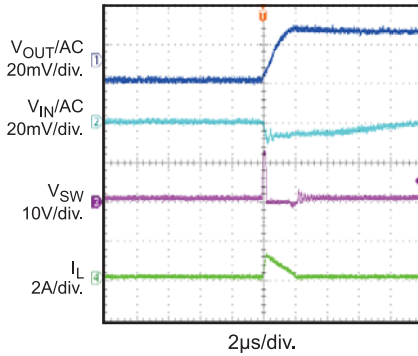
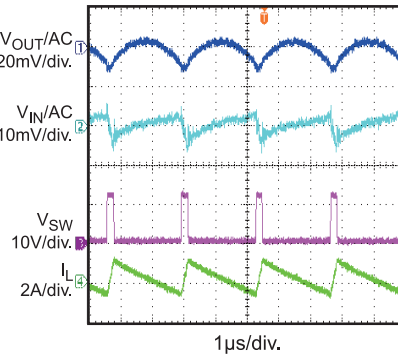
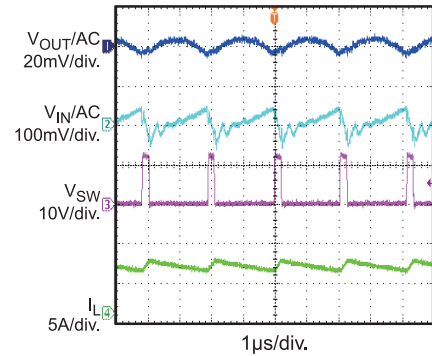
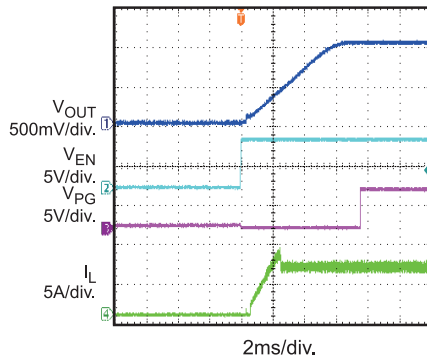
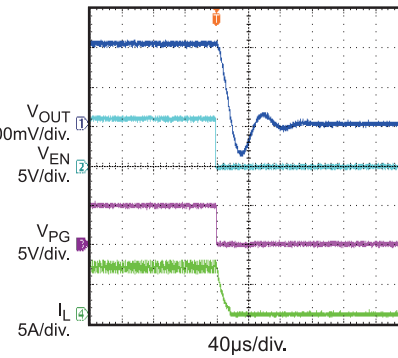
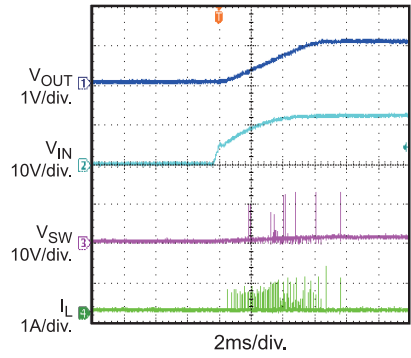
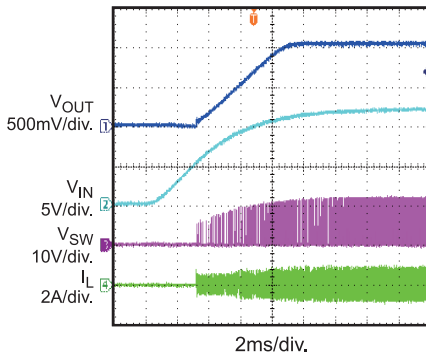
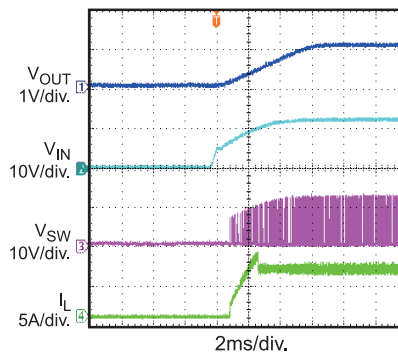
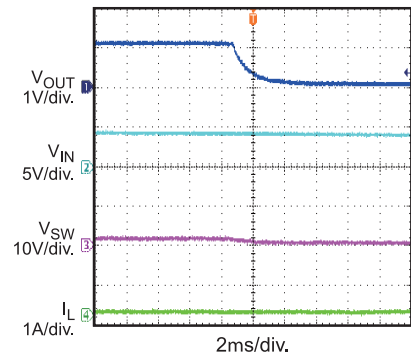
Input/Output Voltage Ripple
 $I_{OUT}=0A$

Input/Output Voltage Ripple
 $I_{OUT}=0A$, PWM Mode

Input/Output Voltage Ripple
 $I_{OUT}=6A$

Power Good Through EN Start-Up
 $I_{OUT}=6A$

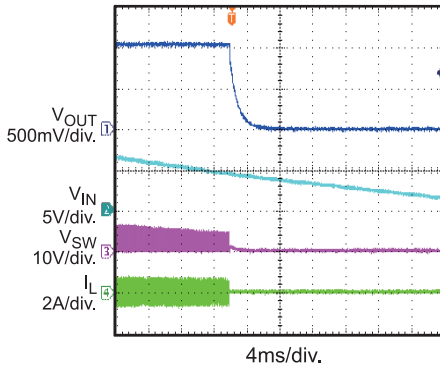
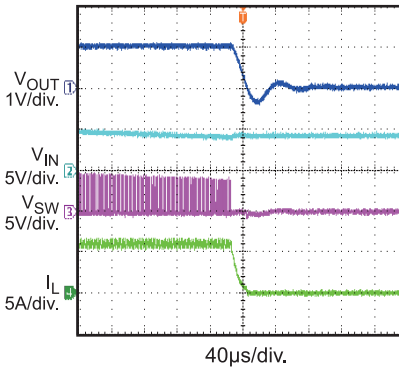
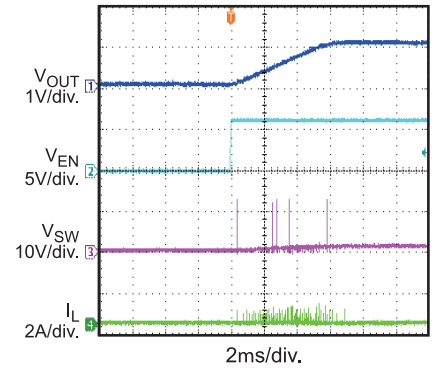
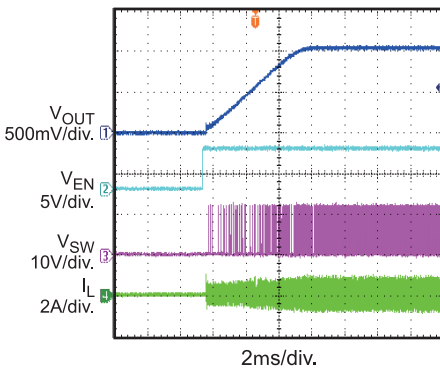
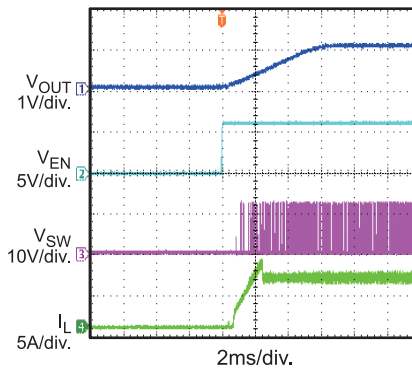
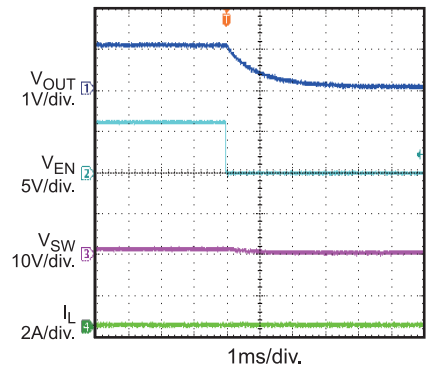
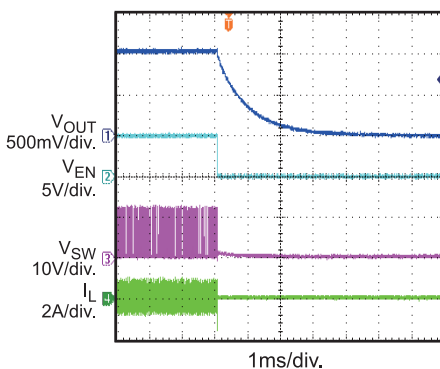
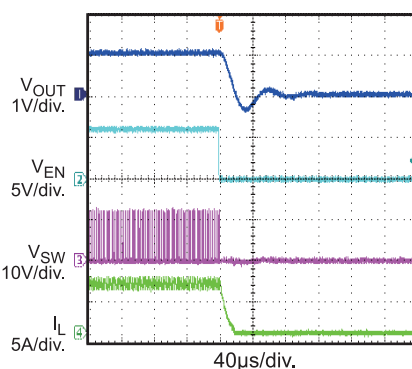
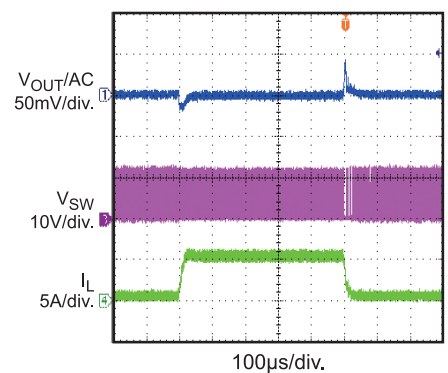
Power Good Through EN Shutdown
 $I_{OUT}=6A$

Start-Up Through VIN
 $I_{OUT}=0A$

Start-Up Through VIN
 $I_{OUT}=0A$, PWM Mode

Start-Up Through VIN
 $I_{OUT}=6A$

Shutdown Through VIN
 $I_{OUT}=0A$

EV8 TEST RESULTS (continued)

Performance waveforms are tested on the EV8765-Q-00A.

 $V_{IN}=12V$, $V_{OUT}=1.05V$, $L=1.5\mu H$, PFM Mode, $T_J=+25^\circ C$, unless otherwise noted.

Shutdown Through V_{IN}
 $I_{OUT}=0A$, PWM Mode

Shutdown Through V_{IN}
 $I_{OUT}=6A$

Start Up through EN
 $I_{OUT}=0A$

Start Up through EN
 $I_{OUT}=0A$, PWM Mode

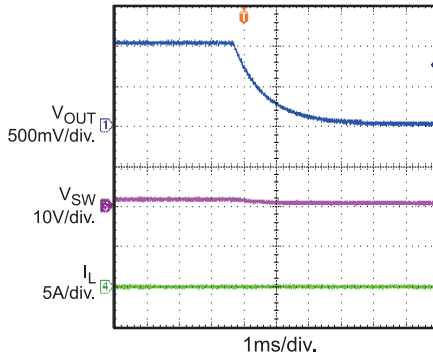
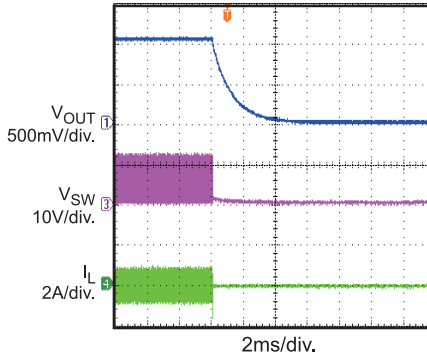
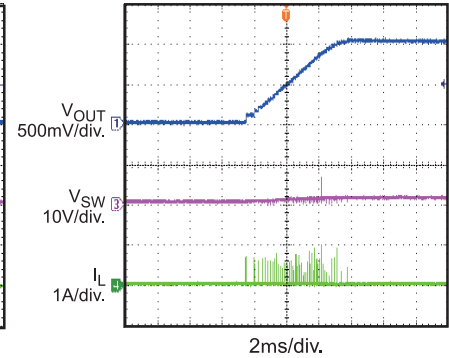
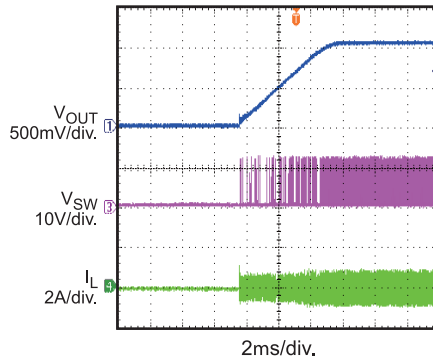
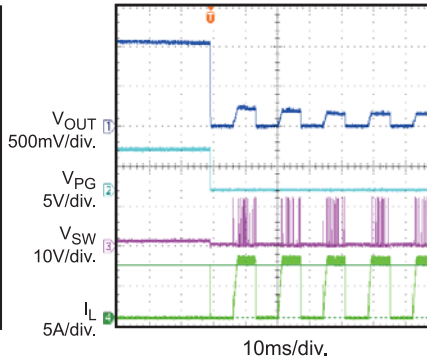
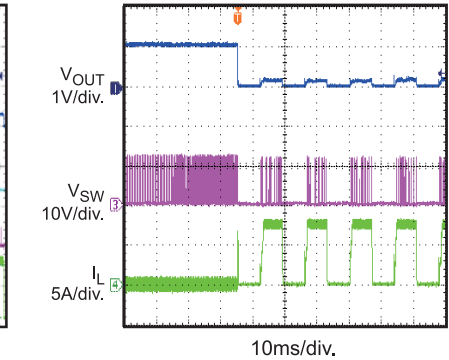
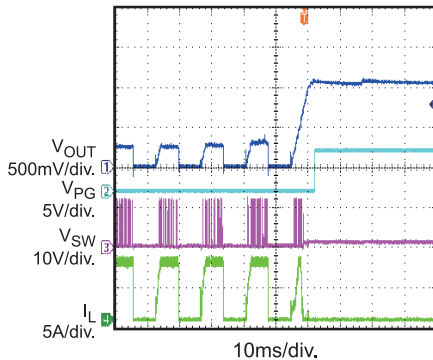
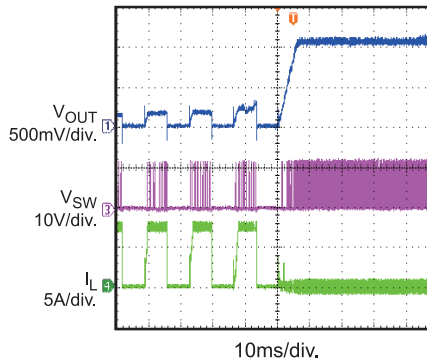
Start Up Through EN
 $I_{OUT}=6A$

Shutdown Through EN
 $I_{OUT}=0A$

Shutdown Through EN
 $I_{OUT}=0A$, PWM Mode

Shutdown Through EN
 $I_{OUT}=6A$

Transient
 $I_{OUT}=0.6A-5.4A@2.5\mu s$,
 $f_{SW}=500kHz$, $C_{OUT}=3x22\mu F$

EVB TEST RESULTS (continued)

Performance waveforms are tested on the EV8765-Q-00A.

 $V_{IN}=12V$, $V_{OUT}=1.05V$, $L=1.5\mu H$, PFM Mode, $T_J=+25^{\circ}C$, unless otherwise noted.

Thermal Shutdown
 $I_{OUT}=0A$

Thermal Shutdown
 $I_{OUT}=0A$, PWM Mode

Thermal Recovery
 $I_{OUT}=0A$

Thermal Recovery
 $I_{OUT}=0A$, PWM Mode

Short Circuit Entry
 $I_{OUT}=0A$

Short Circuit Entry
 $I_{OUT}=0A$, PWM Mode

Short Circuit Recovery
 $I_{OUT}=0A$

Short Circuit Recovery
 $I_{OUT}=0A$, PWM Mode

PRINTED CIRCUIT BOARD LAYOUT

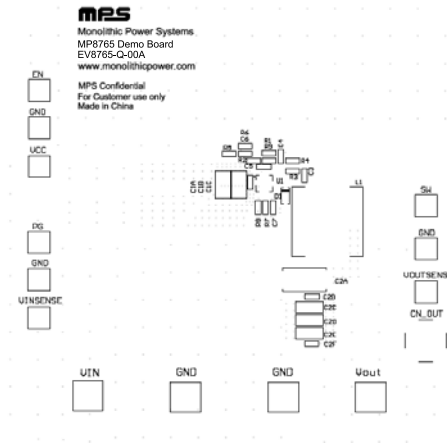

Figure 1: Top Silk Layer

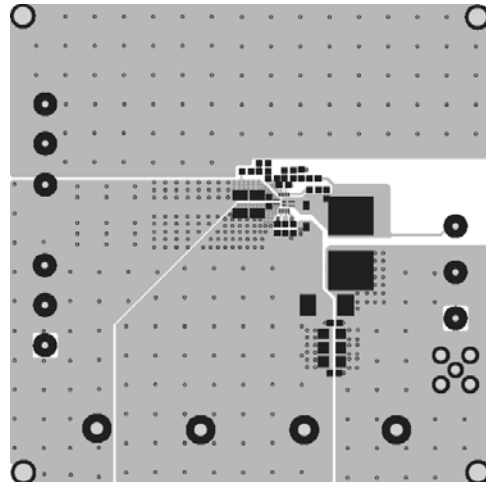

Figure 2: Top Layer

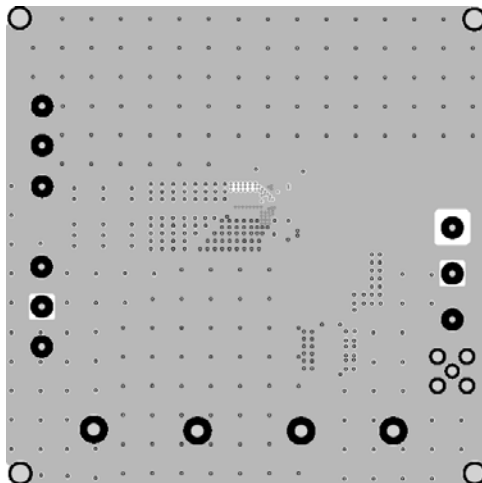

Figure 3: Inner Layer1

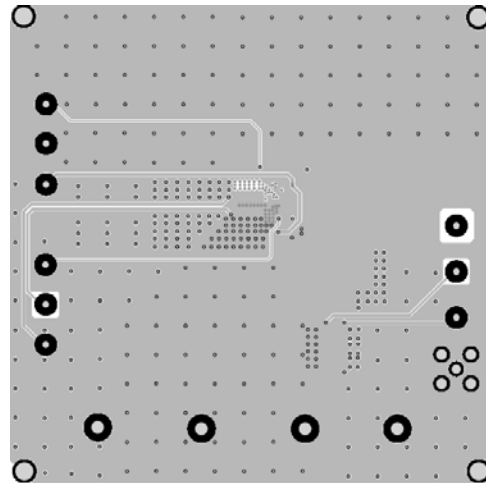

Figure 4: Inner Layer2

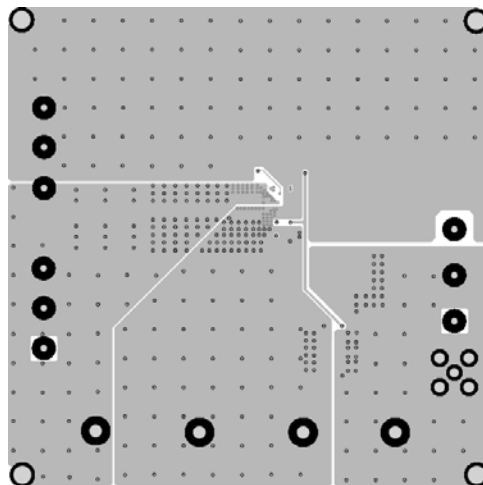

Figure 5: Bottom Layer

QUICK START GUIDE

1. Connect the positive and negative terminals of the load to the VOUT and GND pins respectively.
2. Preset the output of power supply between 5V and 24V, and then turn off the power supply.
3. Connect the positive and negative terminals of the power supply output to the VIN and GND pins respectively:
4. Turn the power supply on. The MP8765GQ will automatically start up.
5. To use the Enable function, apply a digital input to the EN pin. Drive EN higher than 2V to turn on the regulator or less than 0.4V to turn it off.
6. Connect MODE pin to GND (R7=0) to set part work at auto PFM/FWM mode. Float MODE pin (R7=NS) or connect it to VCC can set part work at force PWM mode.
7. Use R1 and R2 to set the output voltage within $V_{FB}=0.604V$. Follow the Application information section in the device datasheet to select the proper value of R1, R2, inductor and output capacitor values when output voltage is changed.
8. If low ripple at light loads is needed, then use 2.0H L1. But with the larger L1, the transient response peak to peak value will become larger too.

NOTICE: The information in this document is subject to change without notice. Please contact MPS for current specifications. Users should warrant and guarantee that third party Intellectual Property rights are not infringed upon when integrating MPS products into any application. MPS will not assume any legal responsibility for any said applications.