

DESCRIPTION

The EV8758H-L-00A is used for demonstrating the performance of MP8758H, a fully-integrated, high efficiency, synchronous step-down switch mode converter. MP8758H provides up to 10A continuous output current over a wide input supply range with constant-on-time control for fast loop response.

The Evaluation Board can deliver 10A continuous load current from a 4.5V to 22V input with excellent load and line regulation.

This part requires minimum number of external components and is available in QFN21 (3mmx4mm) package

ELECTRICAL SPECIFICATION

Parameter	Symbol	Value	Units
Input Voltage	V_{IN}	4.5-22	V
Output Voltage	V_{OUT}	1.2	V
Output Current	I_{OUT}	10	A
Switching Frequency	f_{SW}	500	kHz

FEATURES

- Wide 4.5V to 22V Operating Input Range
- 10A Continuous Output Current
- Low $R_{DS(ON)}$ Internal Power MOSFETs
- Proprietary Switching Loss Reduction Technique
- Internal Soft Start
- Output Discharge
- 500kHz Switching Frequency
- PFM/PWM Mode Selection
- Hiccup Mode OCP, UVP
- Auto Retry Thermal Shutdown, OVP
- Output Adjustable from 0.604V

APPLICATIONS

- Laptop Computer
- Tablet PC
- Networking Systems
- Personal Video Recorders
- Flat Panel Television and Monitors
- Distributed Power Systems

All MPS parts are lead-free and adhere to the RoHS directive. For MPS green status, please visit MPS website under Products, Quality Assurance page.

"MPS" and "The Future of Analog IC Technology", are Registered Trademarks of Monolithic Power Systems, Inc.

EV8758H-L-00A EVALUATION BOARD



(L x W x H) 8.55cm x 8.55cm x 1.6cm

Board Number	MPS IC Number
EV8758H-L-00A	MP8758HGL

Efficiency vs. Output Current

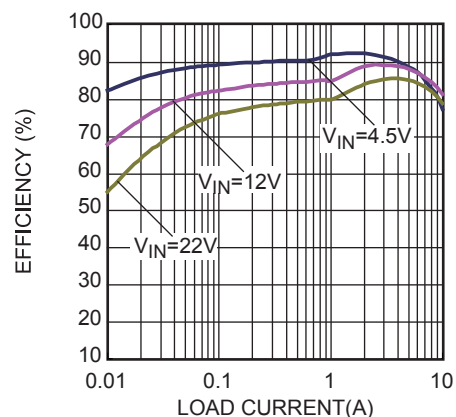

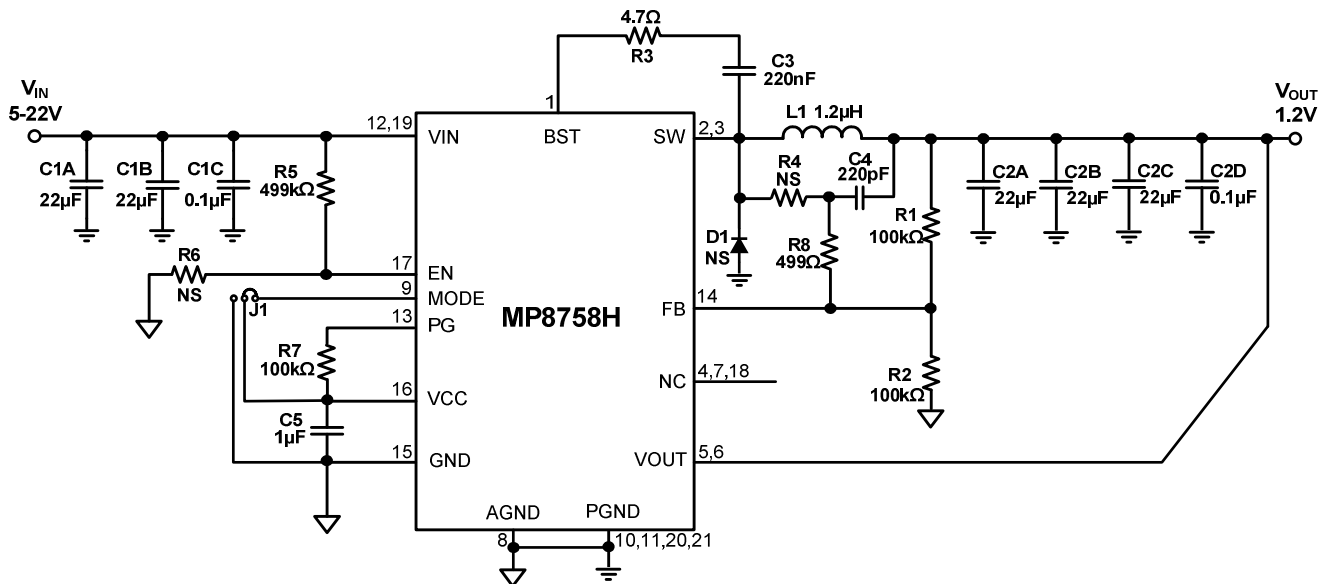
EVALUATION BOARD SCHEMATIC

EV8758H-L-00A BILL OF MATERIALS

Qty	Ref	Value	Description	Package	Manufacturer	Manufacturer P/N
2	C1A,C1B	22 μ F	Ceramic Cap, 25V, X7R	1206	Murata	GRM31ER71E226KE15L
2	C1C,C2D	0.1 μ F	Ceramic Cap, 25V, X7R	0603	Murata	GRM188R71E104KA01D
3	C2A,C2B, C2C	22 μ F	Ceramic Cap, 16V, X5R	1206	Murata	GRM31CR61C226ME15L
1	C3	220nF	Ceramic Cap, 25V, X7R	0603	Murata	GRM188R71E224KA88D
1	C4	220pF	Ceramic Cap, 50V, X7R	0603	Murata	GRM188R71H221KA01D
1	C5	1uF	Ceramic Cap, 25V, X7R	0603	Murata	GRM188R71E105KA12D
1	L1	1.2 μ H	DCR=1.8m Ω , Isat=25A	11mm \times 10.2mm	Wurth	744325120
3	R1,R2,R7	100k Ω	Film Res, 1%	0603	ROYAL	RL0603FR-07100KL
1	R3	4.7 Ω	Film Res, 1%	0603	ROYAL	RL0603FR-074R7L
0	R4,R6	NS				
1	R5	499k Ω	Film Res, 1%	0603	ROYAL	RL0603FR-07499KL
1	R8	499 Ω	Film Res, 1%	SM0603	ROYAL	RL0603FR-07499RL
1	U1	MP8758HGL	DC-DC Converter	QFN3 \times 4	MPS	MP8758HGL

EVB TEST RESULTS

Performance waveforms are tested on the EV8758H-L-00A.

$V_{IN} = 12V$, $V_{OUT} = 1.2V$, $L = 1.2\mu H$, $T_J = +25^\circ C$, unless otherwise noted.

Start-Up through V_{IN}

$I_{OUT} = 0A$, PFM

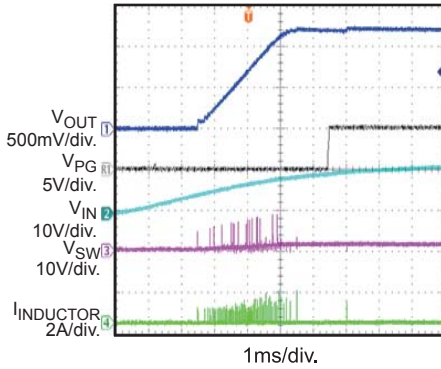

Start-Up through V_{IN}

$I_{OUT} = 0A$, PWM

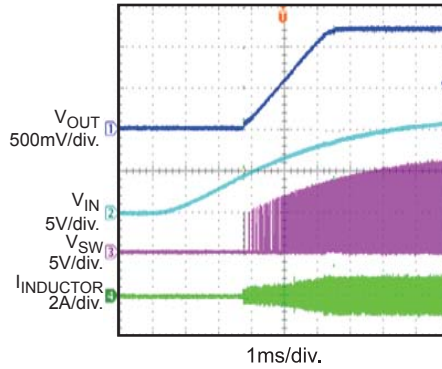

Start-Up through V_{IN}

$I_{OUT} = 10A$

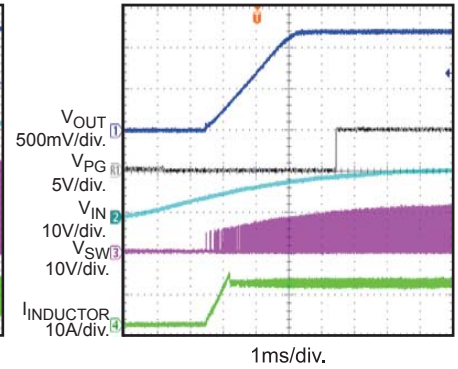

Shutdown through V_{IN}

$I_{OUT} = 0A$, PFM

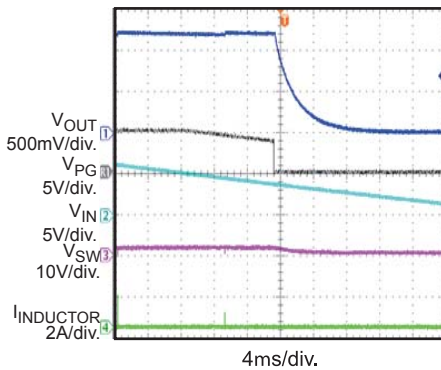

Shutdown through V_{IN}

$I_{OUT} = 0A$, PWM

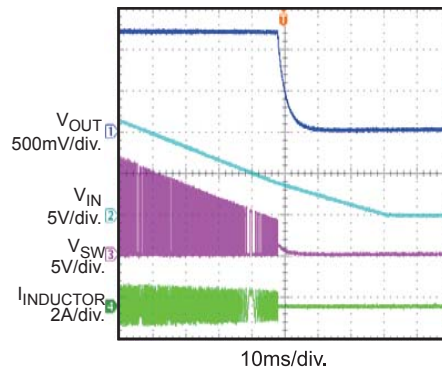

Shutdown through V_{IN}

$I_{OUT} = 10A$

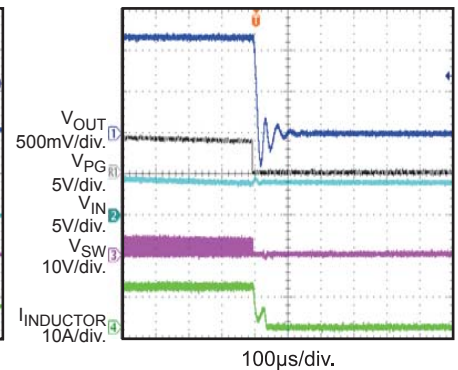

Start-Up through EN

$I_{OUT} = 0A$, PFM

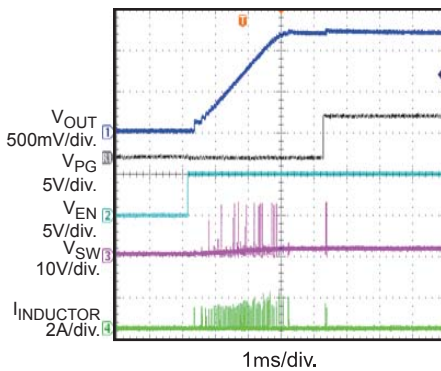

Start-Up through EN

$I_{OUT} = 0A$, PWM

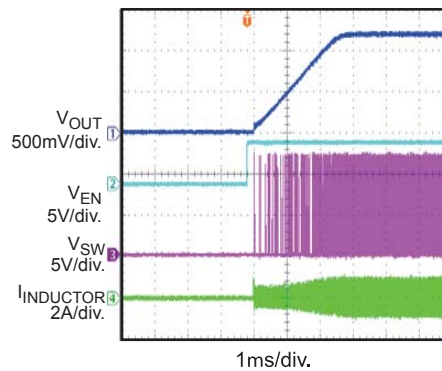

Start-Up through EN

$I_{OUT} = 10A$

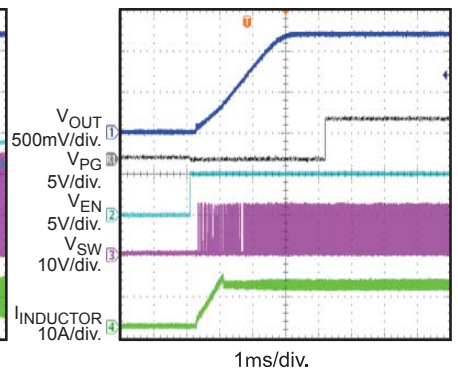

EVB TEST RESULTS (continued)

Performance waveforms are tested on the EV8758H-L-00A.

 $V_{IN} = 12V$, $V_{OUT} = 1.2V$, $L = 1.2\mu H$, $T_J = +25^\circ C$, unless otherwise noted.

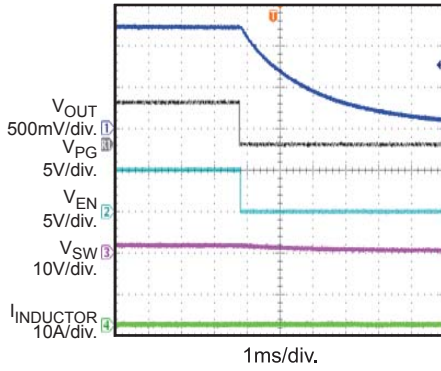
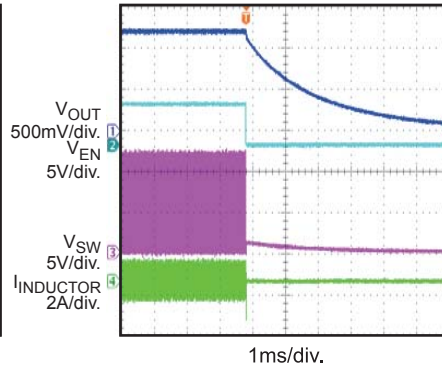
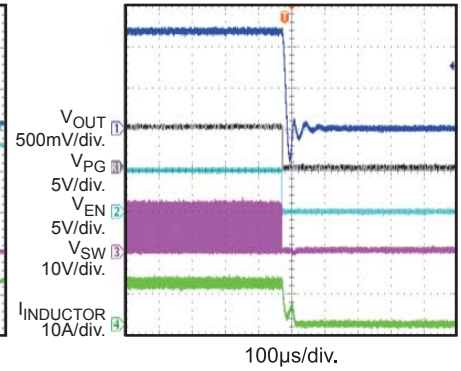
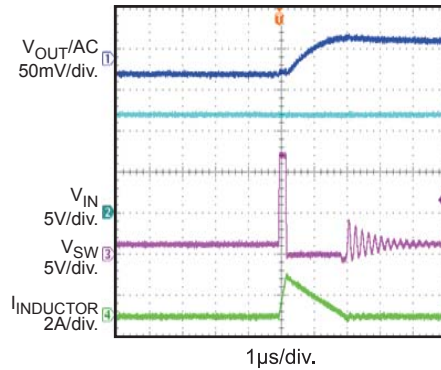
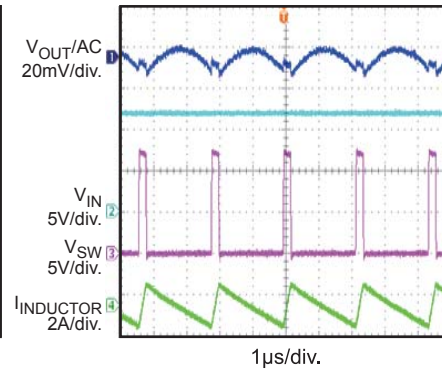
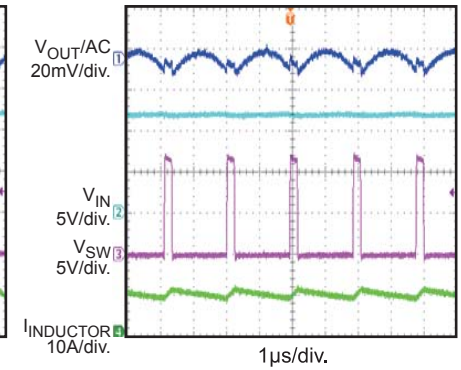
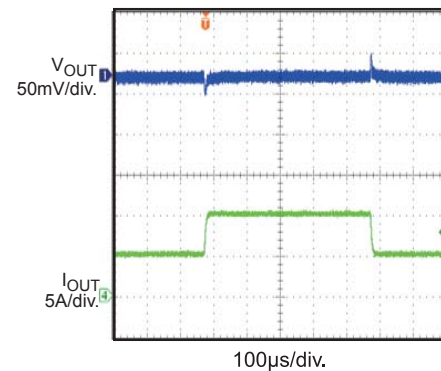
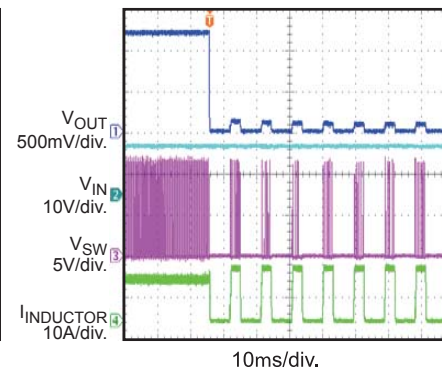
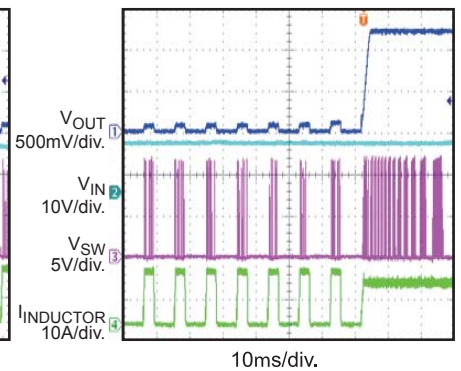
Shutdown through EN
 $I_{OUT} = 0A$, PFM

Shutdown through EN
 $I_{OUT} = 0A$, PWM

Shutdown through EN
 $I_{OUT} = 10A$

Output Voltage Ripple
 $I_{OUT} = 0A$, PFM

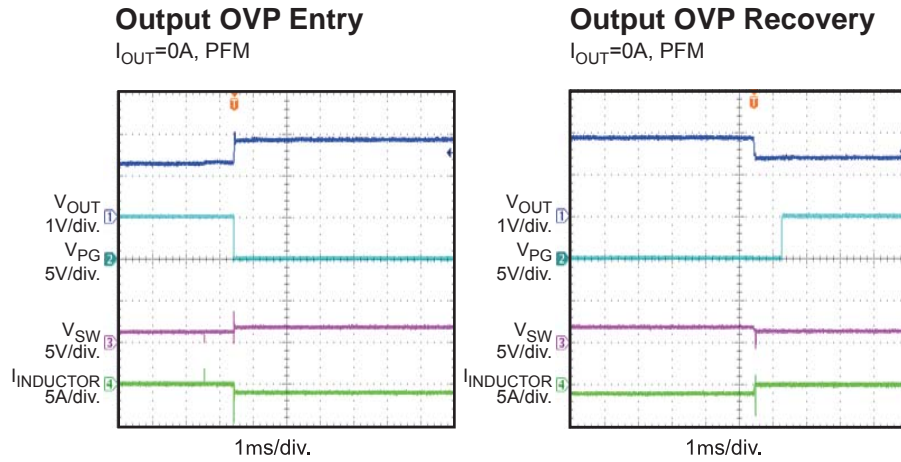
Output Voltage Ripple
 $I_{OUT} = 0A$, PWM

Output Voltage Ripple
 $I_{OUT} = 10A$

Load Transient Response
 $I_{OUT} = 5A$ to $10A$

Short-Circuit Entry
 $I_{OUT} = 10A$

Short-Circuit Recovery
 $I_{OUT} = 10A$

EVB TEST RESULTS *(continued)*

Performance waveforms are tested on the EV8758H-L-00A.

$V_{IN} = 12V$, $V_{OUT} = 1.2V$, $L = 1.2\mu H$, $T_J = +25^\circ C$, unless otherwise noted.



PRINTED CIRCUIT BOARD LAYOUT

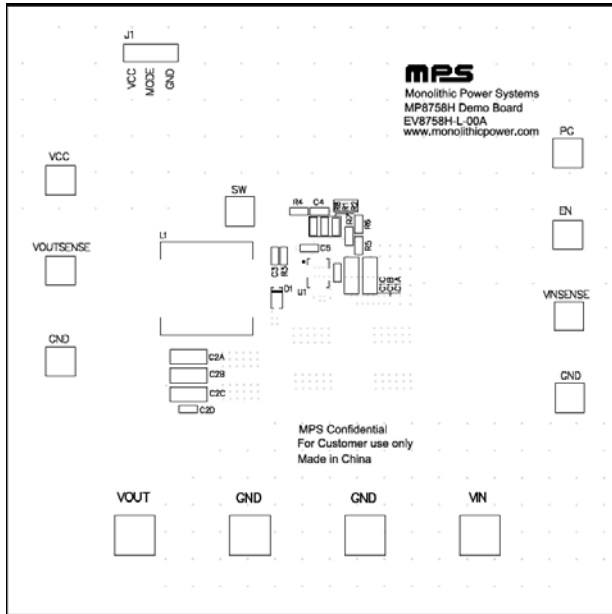

Figure 1: Top Silk Layer

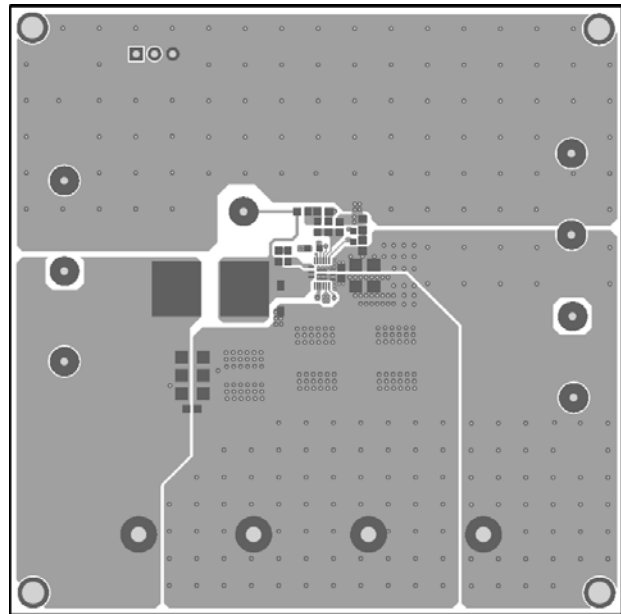

Figure 2: Top Layer

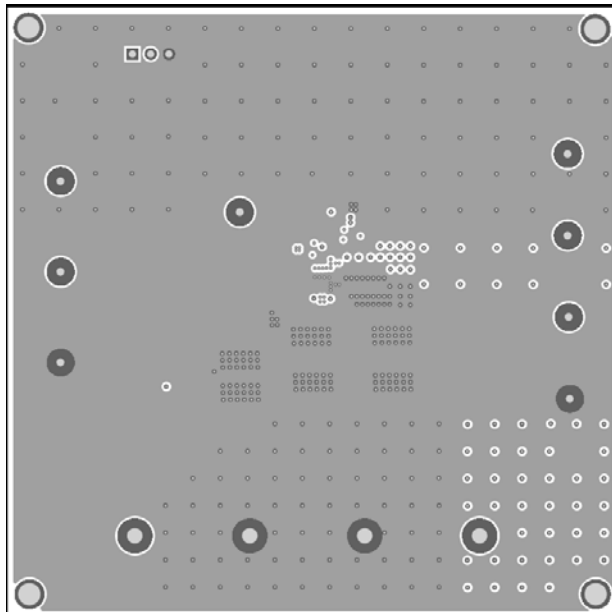

Figure 3: Inner Layer1

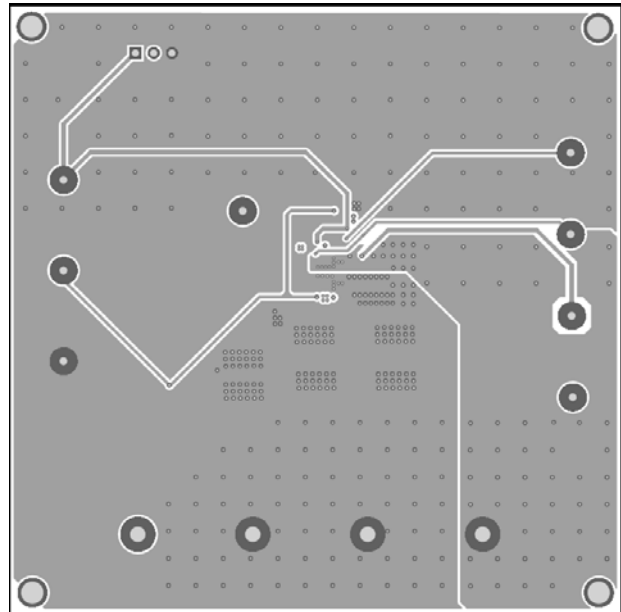

Figure 4: Inner Layer2

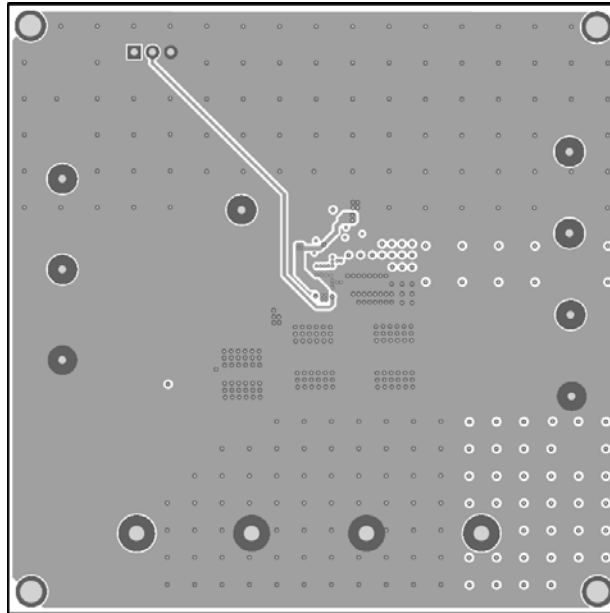

Figure 5: Bottom Layer

QUICK START GUIDE

1. Connect the positive and negative terminals of the load to the VOUT and GND pins respectively.
2. Preset the output of power supply between 4.5V and 22V, and then turn off the power supply.
3. Connect the positive and negative terminals of the power supply output to the VIN and GND pins respectively:
4. Turn the power supply on. The MP8758HGL will automatically start up.
5. To use the Enable function, apply a digital input to the EN pin. Drive EN high to turn on the regulator or low to turn it off
6. Use R1 and R2 to set the output voltage. Follow the Application information section in the device datasheet to select the proper value of R1, R2, inductor and output capacitor values when output voltage is changed.

NOTICE: The information in this document is subject to change without notice. Please contact MPS for current specifications. Users should warrant and guarantee that third party Intellectual Property rights are not infringed upon when integrating MPS products into any application. MPS will not assume any legal responsibility for any said applications.