



The Future of Analog IC Technology®

EV8715-L-00A

100% Duty Cycle Synchronous 4A, 21V, 500kHz Step-Down Converter EV Board

DESCRIPTION

The MP8715 is a 500kHz fixed-frequency PWM synchronous step-down regulator. MP8715 operates from a 4.5V to 21V input and generates an output voltage from 0.8V to V_{IN} with 100% duty cycle operation.

The MP8715 integrates a 120mΩ high-side switch and a 50mΩ synchronous rectifier for high efficiency without an external Schottky diode. It offers a very compact solution to achieve 4A continuous output current over a wide input supply range with excellent load and line regulation.

External soft start and power good indication meet flexible design requirement.

ELECTRICAL SPECIFICATIONS

Parameter	Symbol	Value	Units
Input Voltage	V_{IN}	5 – 21	V
Output Voltage	V_{OUT}	1.2	V
Output Current	I_{OUT}	4	A

FEATURES

- 4A Output Current
- Wide 4.5V to 21V Input Operation Range
- 100% Duty Cycle Support
- 120mΩ/50mΩ Internal Power MOSFET
- All Ceramic Capacitor Design
- Up to 95% Efficiency
- 500kHz Fixed Switching Frequency
- Adjustable Output from 0.8V to V_{IN}
- External Soft-Start
- Frequency Synchronization Input
- Power OK Indicator
- Internal Compensation
- Over Current Hiccup and Thermal Protection
- 14-pin QFN Package with an Exposed Pad

APPLICATIONS

- Cable eMTAs
- μP/ASIC/DSP/FPGA Core and I/O Supplies
- Printers and LCD TVs
- Digital Set Top Boxes
- Network and Telecom Equipment

All MPS parts are lead-free and adhere to the RoHS directive. For MPS green status, please visit MPS website under Products, Quality Assurance page. "MPS" and "The Future of Analog IC Technology" are registered trademarks of Monolithic Power Systems, Inc.

EV8715-L-00A EVALUATION BOARD



Board Number	MPS IC Number
EV8715-L-00A	MP8715DL

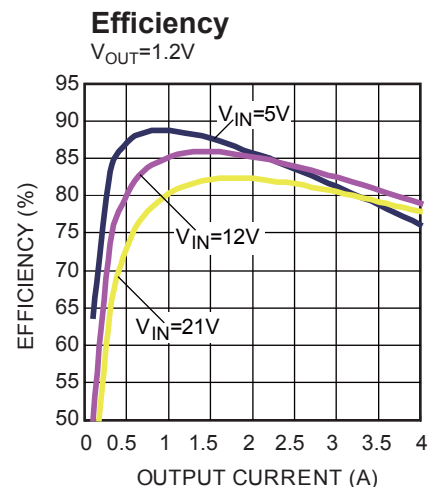

EVALUATION BOARD SCHEMATIC

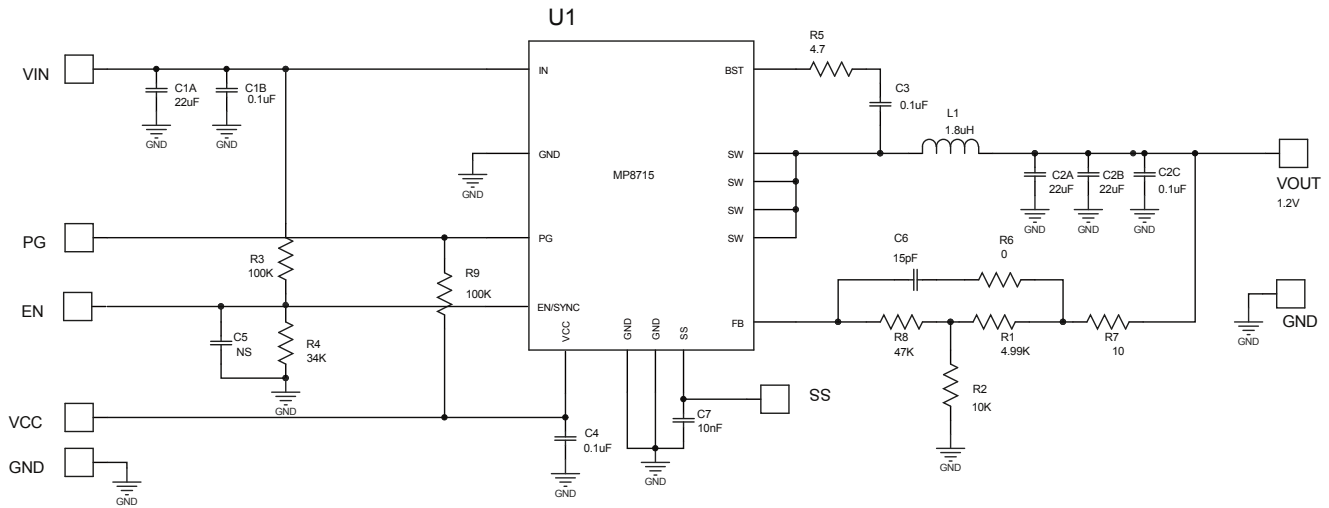

EV8715-L-00A BILL OF MATERIALS

Qty	Ref	Value	Description	Package	Manufacture	Manufacture_PN
3	C1A,C2A, C2B	22µF	Ceramic Capacitor,25V,X7R,1210	1210	muRata	GRM32ER61E226KE15L
4	C1B,C2C, C3,C4	0.1µF	Ceramic Capacitor,50V,X7R,0603	0603	muRata	GRM188R71H104KA93D
1	C6	15pF	Ceramic Capacitor,50V,X7R,0603	0603	muRata	GRM188R71H150KA93D
0	C5	NS				
1	C7	10nF	Ceramic Capacitor,50V,X7R,0603	0603	muRata	GRM188R71H103KA93D
1	L1	1.8µH	Inductor,1.8µH,7.6mΩ,10.4A	SMD	TOKO	D104C-#919AS-1R8N
1	R1	4.99k	Film Resistor,1%	0603	Yageo	RC0603FR-074K99L
1	R2	10k	Film Resistor,1%	0603	Yageo	RC0603FR-0710KL
2	R3,R9	100k	Film Resistor,1%	0603	Yageo	RC0603FR-07100KL
1	R4	34k	Film Resistor,1%	0603	Yageo	RC0603FR-0734KL
1	R5	4.7Ω	Film Resistor,1%	0603	Yageo	RC0603FR-074R7L
1	R6	0Ω	Film Resistor,1%	0603	Yageo	RC0603FR-070RL
1	R7	10Ω	Film Resistor,1%	0603	Yageo	RC0603FR-0710RL
1	R8	47k	Film Resistor,1%	0603	Yageo	RC0603FR-0747KL
1	U1		Step Down Converter	QFN3X4-14	MPS	MP8715DL

EVB TEST RESULTS

Performance waveforms are tested on the evaluation board.

$V_{IN}=12V$, $V_{OUT}=1.2V$, $L=1.8\mu H$, $T_A=+25^{\circ}C$, unless otherwise noted.

Line Regulation

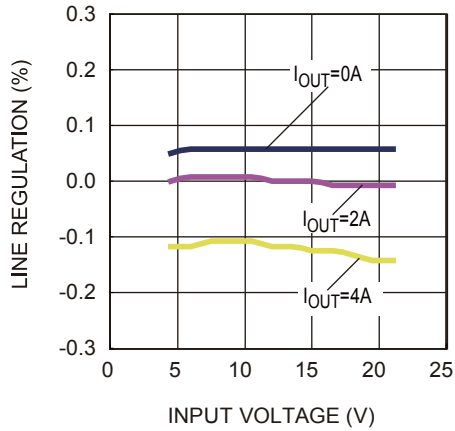

Load Regulation

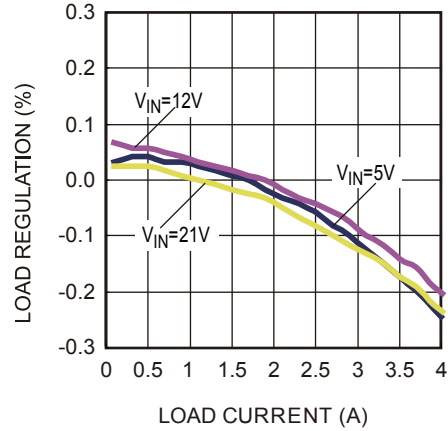

EVB TEST RESULTS

Performance waveforms are tested on the evaluation board.

VIN=12V, VOUT=1.2V, L=1.8μH, TA=+25°C, unless otherwise noted.

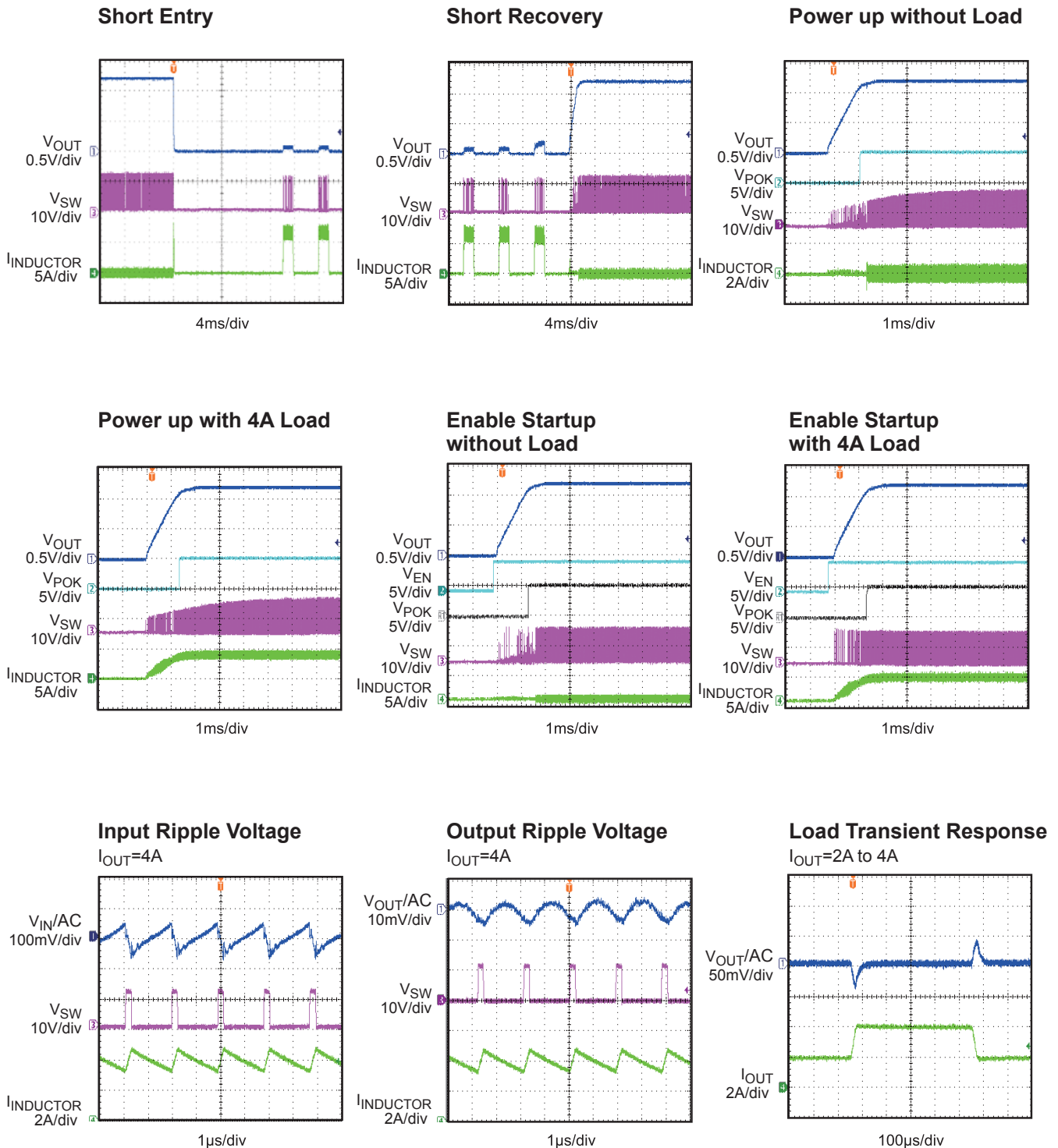

PRINTED CIRCUIT BOARD LAYOUT

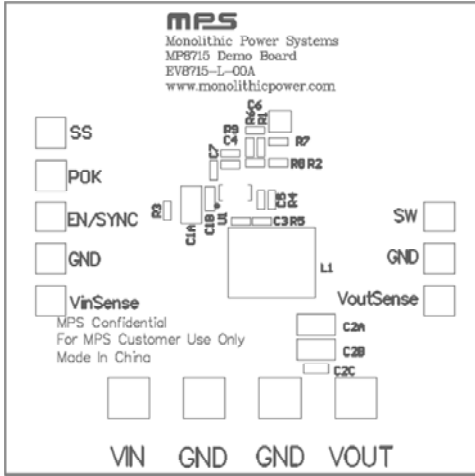

Figure 1—Top Silk Layer

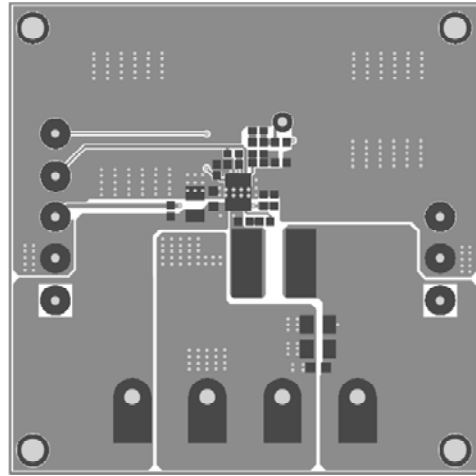

Figure 2—Top Layer

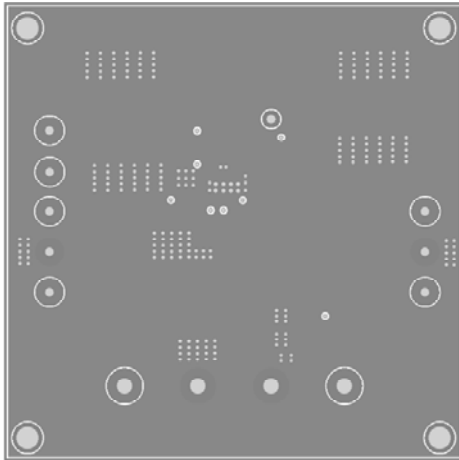

Figure 3—Inner1 Layer

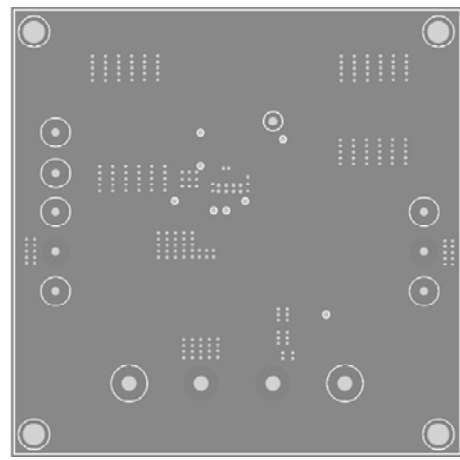

Figure 4—Inner2 Layer

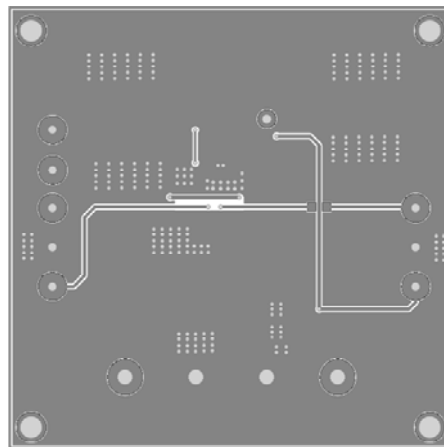

Figure 5—Bottom Layer

QUICK START GUIDE

1. Connect the positive and negative terminals of the load to the VOUT and GND pins, respectively.
2. Preset the power supply output between 5V and 21V, then turn off the power supply.
3. Connect the positive and negative terminals of the power supply output to the VIN and GND pins, respectively.
4. Turn the power supply on. The board will automatically startup.
5. To use the Enable function, apply a digital input to the EN pin. Drive EN higher than 2V to turn on the regulator or less than 0.4V to turn it off.
6. Apply up to 2MHz frequency logic level clock signal to the EN pin to synchronize the device to an external clock. The duty cycle is not critical.

NOTICE: The information in this document is subject to change without notice. Users should warrant and guarantee that third party Intellectual Property rights are not infringed upon when integrating MPS products into any application. MPS will not assume any legal responsibility for any said applications.