

### DESCRIPTION

The MP8642 is a dual monolithic step-down switch mode converter with built-in internal power MOSFETs. It achieves 3A continuous output current for each output over a wide input supply range with excellent load and line regulation.

Current mode operation provides fast transient response and eases loop stabilization.

Fault condition protection includes cycle-by-cycle current limiting and thermal shutdown.

The MP8642 requires a minimum number of readily available standard external components.

### ELECTRICAL SPECIFICATIONS

Parameter	Symbol	Value	Units
Input Voltage	V <sub>IN</sub>	4.5 – 23	V
Output Voltage	V <sub>OUT</sub>	3.3/1.8	V
Output Current	I <sub>OUT</sub>	3	A

### FEATURES

- 3A Current for Each Output
- 80mΩ Internal Power MOSFET Switch
- Stable with Low ESR Output Ceramic Capacitors
- Up to 92% Efficiency
- Power Good Indicator
- Fixed 600 KHz Frequency
- Synchronizable to >1MHz External Clock
- Thermal Shutdown
- Cycle-by-Cycle Over Current Protection
- Wide 4.5V to 23V Operating Input Range
- Available in a 5mm x 5mm 32-Pin QFN Package

### APPLICATIONS

- Point of Load Regulator in Distributed Power Systems
- Digital Set Top Boxes
- Personal Video Recorders
- Broadband Communications
- Flat Panel Television and Monitors

"MPS" and "The Future of Analog IC Technology" are Registered Trademarks of Monolithic Power Systems, Inc.

### EV8642DU-00A EVALUATION BOARD



(L x W x H) 3.0" x 3.0" x 0.5"  
(7.6cm x 7.6cm x 1.3cm)

Board Number	MPS IC Number
EV8642DU-00A	MP8642DU

Efficiency vs. Output Current

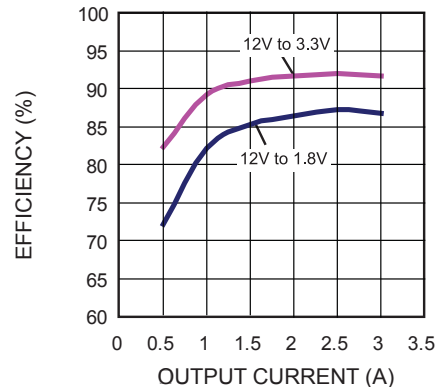

## EVALUATION BOARD SCHEMATIC

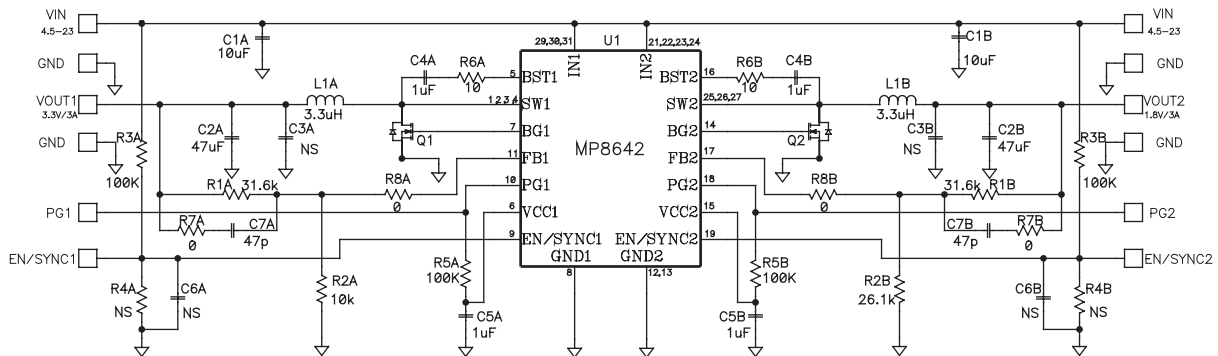

## EV8642DU-00A BILL OF MATERIALS

Qty	Ref	Value	Description	Package	Manufacturer	Manufacturer P/N
2	R1A, R1B	31.6k	Film Res., 1%	0603	Yageo	RC0603FR-0731K6L
1	R2A	10k	Film Res., 1%	0603	Yageo	RC0603FR-0710KL
1	R2B	26.1k	Film Res., 1%	0603	Yageo	RC0603FR-0726K1L
4	R3A, R3B, R5A, R5B	100k	Film Res., 5%	0603	Any	
0	R4A, R4B	NS	Not Stuffed			
2	R6A, R6B	10	Film Res., 5%	0603	Any	
4	R7A, R7B, R8A, R8B	0	Film Res., 5%	0603	Yageo	RC0603JR-070RL
2	C1A, C1B	10uF	Ceramic Cap., 25V X7R	1210	Murata	GRM32DR71E106KA12
2	C2A, C2B	47uF	Ceramic Cap., 10V X5R	1210	Murata	GRM32ER61A476KE20L
0	C3A, C3B	NS				
4	C4A, C4B, C5A, C5B	1uF	Ceramic Cap., 16V X7R	0603	Murata	GRM188R71C105KA12D
0	C6A, C6B	NS	Not Stuffed			
2	C7A, C7B	47pF	Ceramic Cap., 50V C0G	0603	Murata	GRM1885C1H470JZ01
1	U1		MP8642DU-LF	QFN32	MPS	MP8642DU-LF
2	Q1, Q2		N MOSFET, 30V, 8.2mΩ	Powerpak 1212	Vishay	Si7112DN
2	L1A, L1B	3.3uH	27mΩ DCR, 6A	SMD	TDK	SPM6530T-3R3M
		3.9uH	33mΩ DCR, 4.2A	SMD	TOKO	DS84LC-B1015AS-3R9N

## PRINTED CIRCUIT BOARD LAYOUT

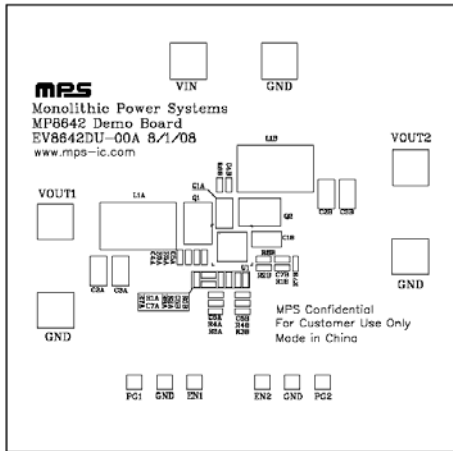

Figure 1—Top Silk Layer

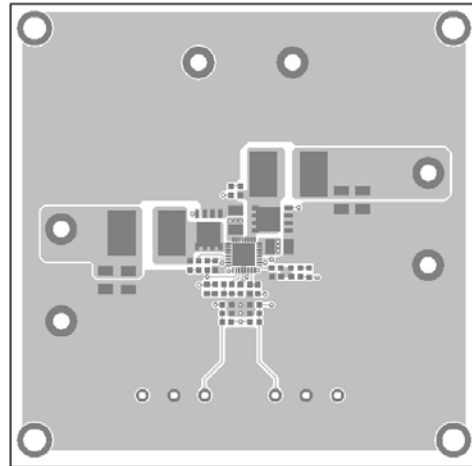

Figure 2—Top Layer

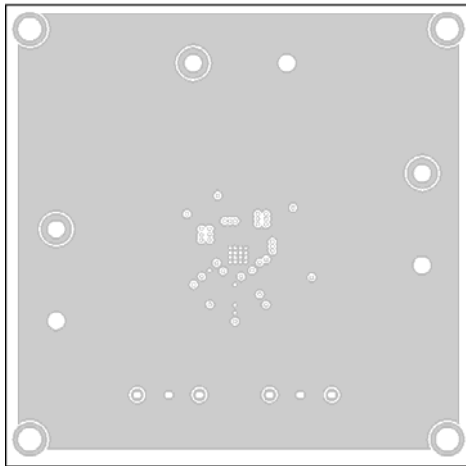

Figure 3—Inner Layer 1

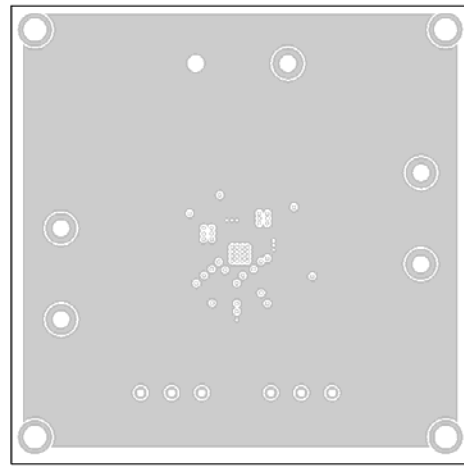

Figure 4—Inner Layer 2

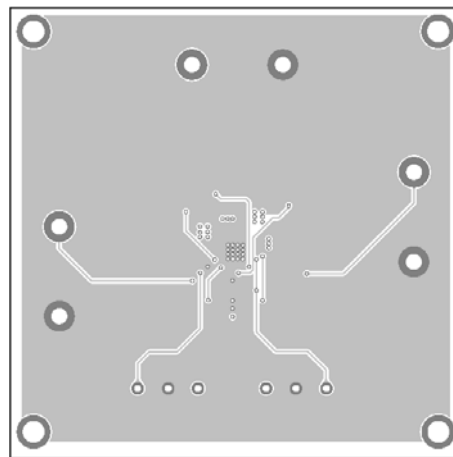

Figure 5—Bottom Layer

## QUICK START GUIDE

1. Connect the positive and negative terminals of the load to VOUT and GND pins, respectively.
2. Preset the power supply output to 4.5V – 23V and turn off the power supply.
3. Connect the positive and negative terminals of the power supply output to the VIN and GND pins, respectively.
4. Turn the power supply on. The board will automatically startup.
5. To use the Enable function, apply a digital input to EN pin. Drive EN higher than 1.2V to turn on the regulator, drive EN less than 0.4V to turn it off.
6. Apply up to 1MHz frequency logic level clock signal to the EN pin to synchronize the device to an external clock. The duty cycle is not critical.

**NOTICE:** The information in this document is subject to change without notice. Users should warrant and guarantee that third party Intellectual Property rights are not infringed upon when integrating MPS products into any application. MPS will not assume any legal responsibility for any said applications.