



The Future of Analog IC Technology®

EV8126DF-00A

550mA, 8-14V Input, LNB Power Supply and Control Voltage Regulator Evaluation Board

DESCRIPTION

The EV8126DF-00A is an evaluation board for MP8126, which is LNB power supply and control voltage regulator. The board provides efficient, low noise power to the Satellite receiver's RF LNB (Low Noise Block) converter.

The board accepts the supply voltage from 8V to 14V and the load current can be up to 550mA. The current limit can be adjustable with an external resistor.

The board provides a number of features described in the European EUTELSAT specification (DiSEqC) including: voltage selection of horizontal or vertical polarization directions of LNB and a selectable V_{OUT} compensation for voltage drop on the long coaxial cable. In accordance with DiSEqC standard, the part can detect 22kHz signal and output it with the builtin amplitudes and rise/fall times.

FEATURES

- DiSEqC 1.x Compatibility
- 8V to 14V Input Voltage
- Up to 550mA Output Current
- Programmable Current Limit
- 1V Line Drop Compensation
- Adjustable Soft-start Time
- POK Indicator
- Short Circuit Protection
- Over Temperature Protection

APPLICATIONS

- LNB Power Supply and Control for Satellite Set Top Boxes

All MPS parts are lead-free and adhere to the RoHS directive. For MPS green status, please visit MPS website under Products, Quality Assurance page. "MPS" and "The Future of Analog IC Technology" are registered trademarks of Monolithic Power Systems, Inc.

ELECTRICAL SPECIFICATION

Parameter	Symbol	Value	Units
Input Voltage	V_{IN}	8-14	V
Output Voltage	V_{OUT}	19	V
Output Current	I_{OUT}	0-0.55	A

EV8126DF-00A EVALUATION BOARD



(L x W x H) 2.9" x 2.9" x 0.4"
7.3cm x 7.3cm x 1cm

Board Number	MPS IC Number
EV8126DF-00A	MP8126DF

Efficiency for 19V output

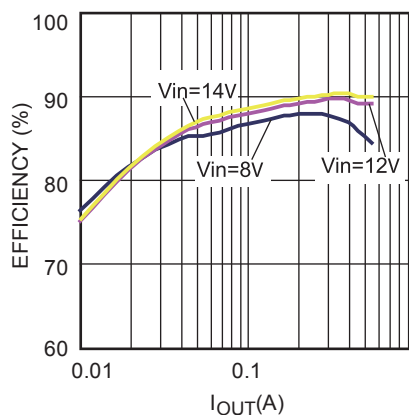

EVALUATION BOARD SCHEMATIC

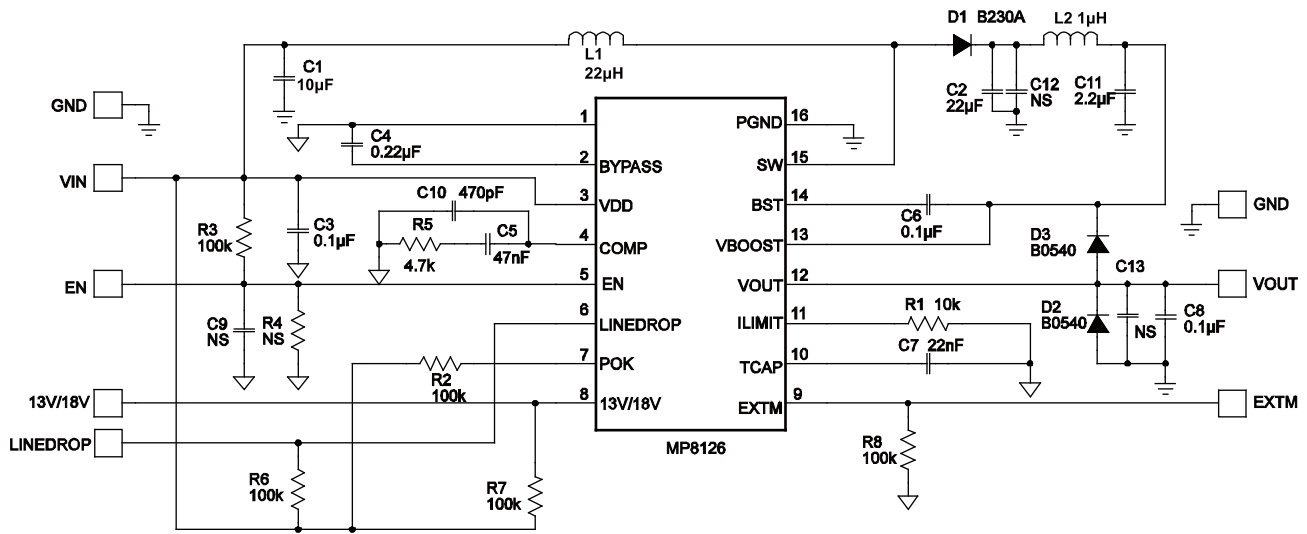

EV8126DF-00A BILL OF MATERIALS

Qty	Ref Des	Value	Description	Package	Manufacturer	Manufacturer P/N
1	C1	10µF	Ceramic Cap, X7R, 25V	1210	muRata	GRM32DR71E106KA12
1	C2	22µF	Ceramic Cap, X7R, 25V	1210	muRata	GRM32ER71E226KE15L
3	C3, C6, C8	0.1µF	Ceramic Cap, X7R, 100V	0603	muRata	GRM188R71H104KA93D
1	C4	0.22µF	Ceramic Cap, X7R, 16V	0603	muRata	GRM188R71C224KA01A
1	C5	47nF	Ceramic Cap, X7R, 50V	0603	muRata	GRM188R71H473KA61D
1	C7	22nF	Ceramic Cap, X7R, 50V	0603	muRata	GRM188R71223KA01D
0	C9	NS	Do Not Stuff	0603		
1	C10	470pF	Ceramic Cap, X7R, 50V	0603	muRata	GRM188R71H471KA01D
1	C11	2.2µF	Ceramic Cap, X7R, 50V	1206	muRata	GRM31CR71H225KA88L
0	C12, C13	NS	Do Not Stuff	1210		
1	R1	10k	Film Res, 1%	0603	Yageo	RC0603FR-0710KL
5	R2, R3, R6, R7, R8	100k	Film Res, 5%	0603	Royalohm	0603J0104T5E
0	R4	NS	Do Not Stuff	0603		
1	R5	4.7k	Film Res, 5%	0603	Yageo	RC0603JR-074K7L
1	D1		30V, 2A	SMA	Diodes	B230A
2	D2, D3		40V, 0.5A	SOD-123	Diodes	SDB0540
1	L1	22µH	SMD, 3A, 77.6mΩ	SMD	TOKO	D104C-919AS-220M
1	L2	1µH	SMD, 3.7A, 17mΩ	SMD	TOKO	D62LCB-#A918CY-1R0M
1	U1			TSSOP16	MPS	MP8126DF

EVB TEST RESULTS

Performance waveforms are tested on the evaluation board.

$V_{IN} = 12V$, $V_{OUT} = 19V$, $L = 22\mu H$, $T_A = 25^\circ C$, unless otherwise noted.

Efficiency for 19V output

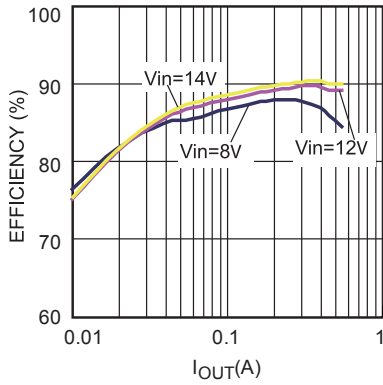

Efficiency for 14V output

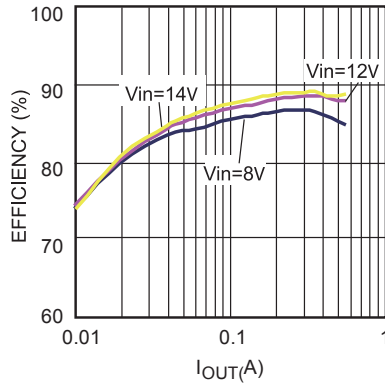

EN Startup

$I_{OUT} = 0.55A$

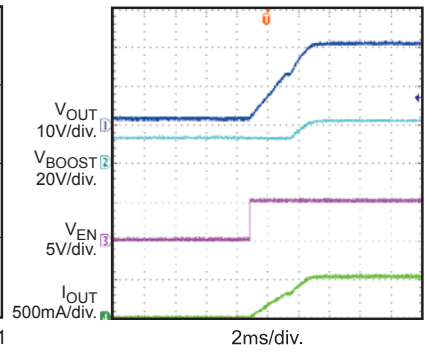

EN Shutdown

$I_{OUT} = 0.55A$

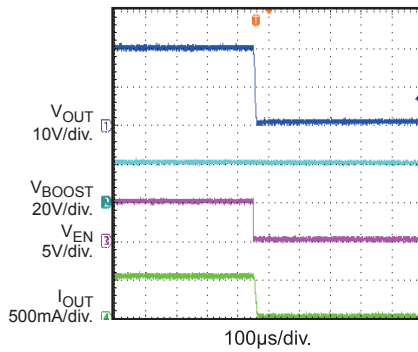

13V to 18V Switch

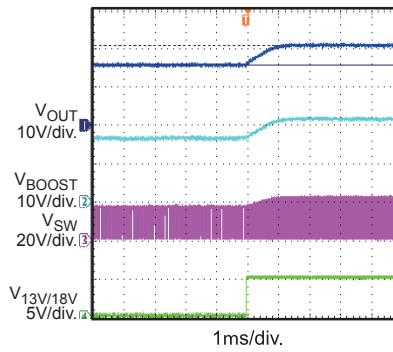

18V to 13V Switch

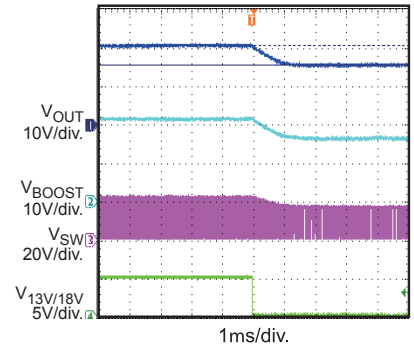

Current Limit Protection

$R_{LIMIT} = 10k\Omega$

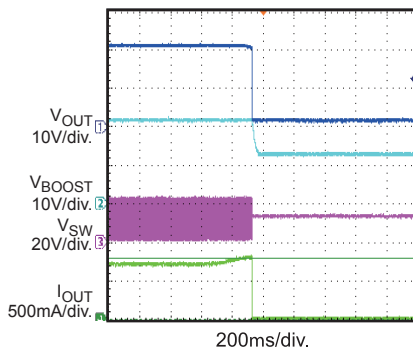

22kHz Tone Signal

$I_{OUT} = 0.1A$

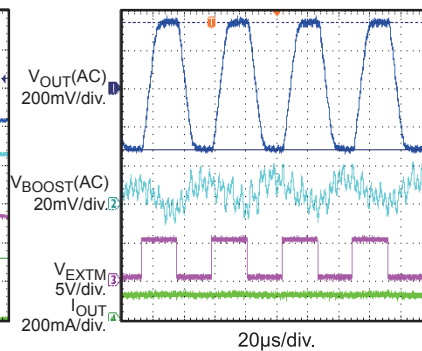

Steady State

$I_{OUT} = 0.55A$

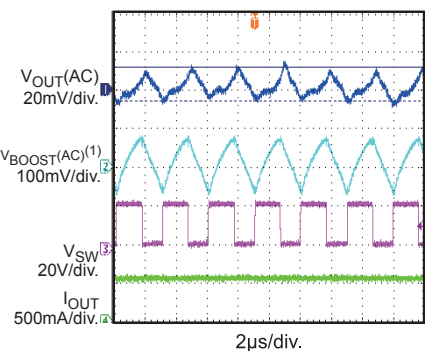

Note:

- 1) Before filter inductor L2.

PRINTED CIRCUIT BOARD LAYOUT

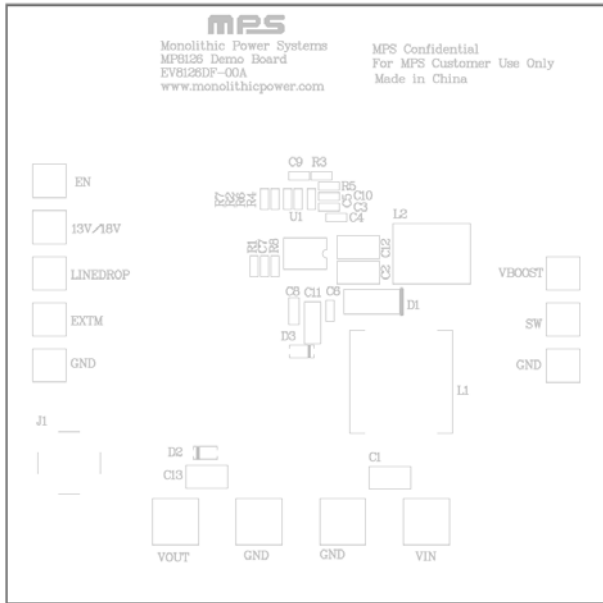

Figure 1—Top Silk Layer

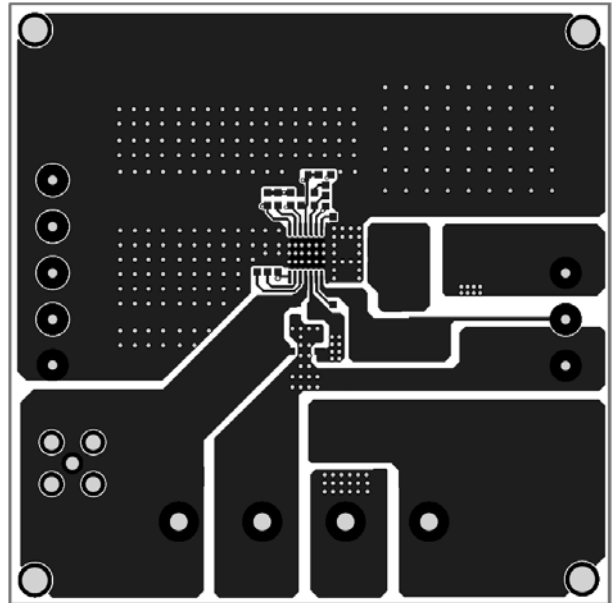

Figure 2—Top Layer

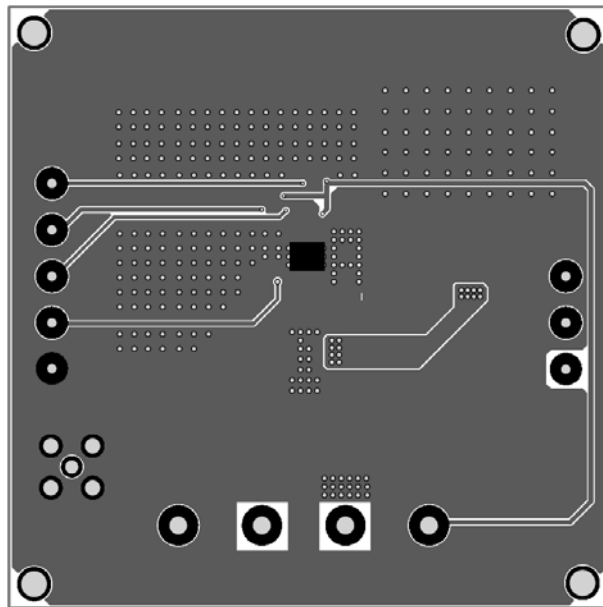

Figure 3—Bottom Layer

QUICK START GUIDE

1. Connect the positive terminal of the load to VOUT pins, and the negative terminal of the load to GND pins.
2. Preset the power supply output to 8~14V and turn off the power supply.
3. Connect the positive terminal of the power supply output to the VIN pin and the negative terminal of the power supply output to the GND pin.
4. Turn on the power supply. The board will automatically start up.
5. To use the Enable function, apply a logic input to the EN pin. Set EN higher than 2V to turn on the regulator or lower than 0.8V to turn it off.
6. To generate tone signal on output, apply a logic input to the EXTM pin. Set EXTM higher than 2V to activate the function or lower than 0.8V to deactivate it.
7. The output voltage of this board is set to 19V. To adjust the output voltage, apply a logic input on 13V/18V or LINEDROP pin. The output voltage under different conditions is shown in below table. “High” represents a voltage higher than 2V, “Low” represents a voltage lower than 0.8V.

13V/18V	LINEDROP	VOUT
High	High	19V
High	Low	18V
Low	High	14V
Low	Low	13V

8. The current limit can be adjusted by R1 and the soft start time be adjusted by C7. For further information, please refer to MP8126 datasheet.

NOTICE: The information in this document is subject to change without notice. Users should warrant and guarantee that third party Intellectual Property rights are not infringed upon when integrating MPS products into any application. MPS will not assume any legal responsibility for any said applications.