



The Future of Analog IC Technology®

EV7782DF-00A

50W Class D Mono Bridged Audio Amplifier Evaluation Board

DESCRIPTION

The EV7782DF-00A is the demo board for the MP7782, a Mono, 50W Class D Audio Amplifier. It is one of MPS' second generation of fully integrated audio amplifiers which dramatically reduces solution size by integrating four 180mΩ Power MOSFETs in a space saving TSSOP20 Package. It utilizes a full bridge output structure capable of delivering 50W into 6Ω speakers. As in all other MPS Class D Audio Amplifiers, this device exhibits the high fidelity of a Class AB amplifier with an efficiency of 90%. The circuit is based on the MPS' proprietary variable frequency modulation topology (patents pending) that delivers excellent PSRR, fast response time and operates on a single power supply.

ELECTRICAL SPECIFICATIONS

Parameter	Symbol	Value	Units
Supply Voltage	V _{DD}	9.5 to 24	V

FEATURES

- 50W into 6Ω with V_{DD} = 24V @ 10% THD+N
- 90% Efficiency
- Typical THD+N = 0.06% @ 1W
- 9.5V to 24V Supply Voltage Operation
- Full Bridge Output Drive
- 4 Integrated 180mΩ Switches
- Turn-On / Turn-Off Click and Pop Suppression
- Integrated Short Circuit Protection
- Integrated Thermal Shutdown
- Mute / Standby Mode
- Thermally Enhanced TSSOP20F Package with Exposed Pad

APPLICATIONS

- Flat Panel LCD and PDP Displays
- Notebook and Multimedia Computers
- Televisions
- Home Stereos
- DVD and VCD Players
- Game Devices and Systems
- Subwoofer

"MPS" and "The Future of Analog IC Technology" are Registered Trademarks of Monolithic Power Systems, Inc.

EV7782DF-00A EVALUATION BOARD

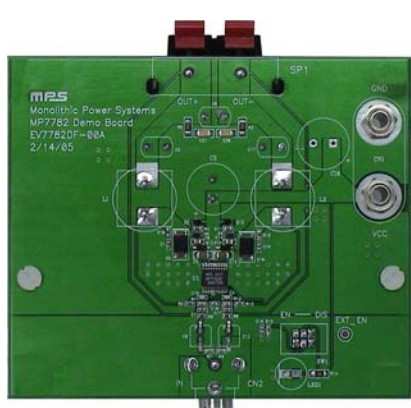
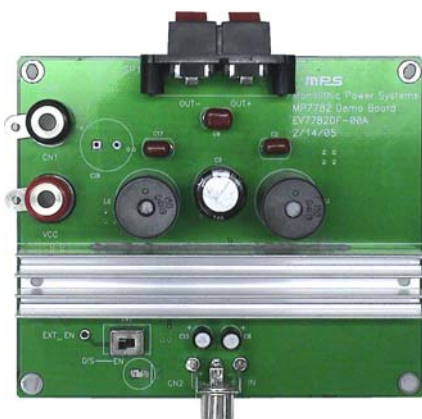

THD+N vs. Output Power

V_{DD} = 24V, R_L = 6Ω, A_V = 30

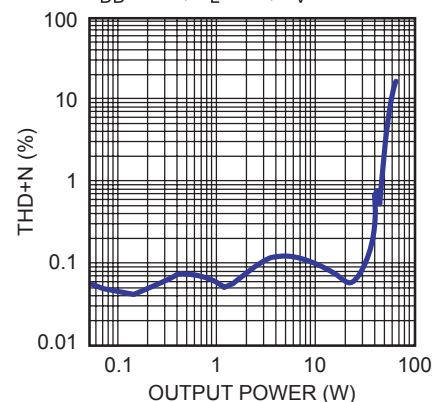

EV7782-EC01

(L x W x H) 4.0" x 3.5" x 1.0" (10.1cm x 8.8cm x 2.5cm)

Board Number	MPS IC Number
EV7782DF-00A	MP7782DF

EVALUATION BOARD SCHEMATIC

EV7782_S01

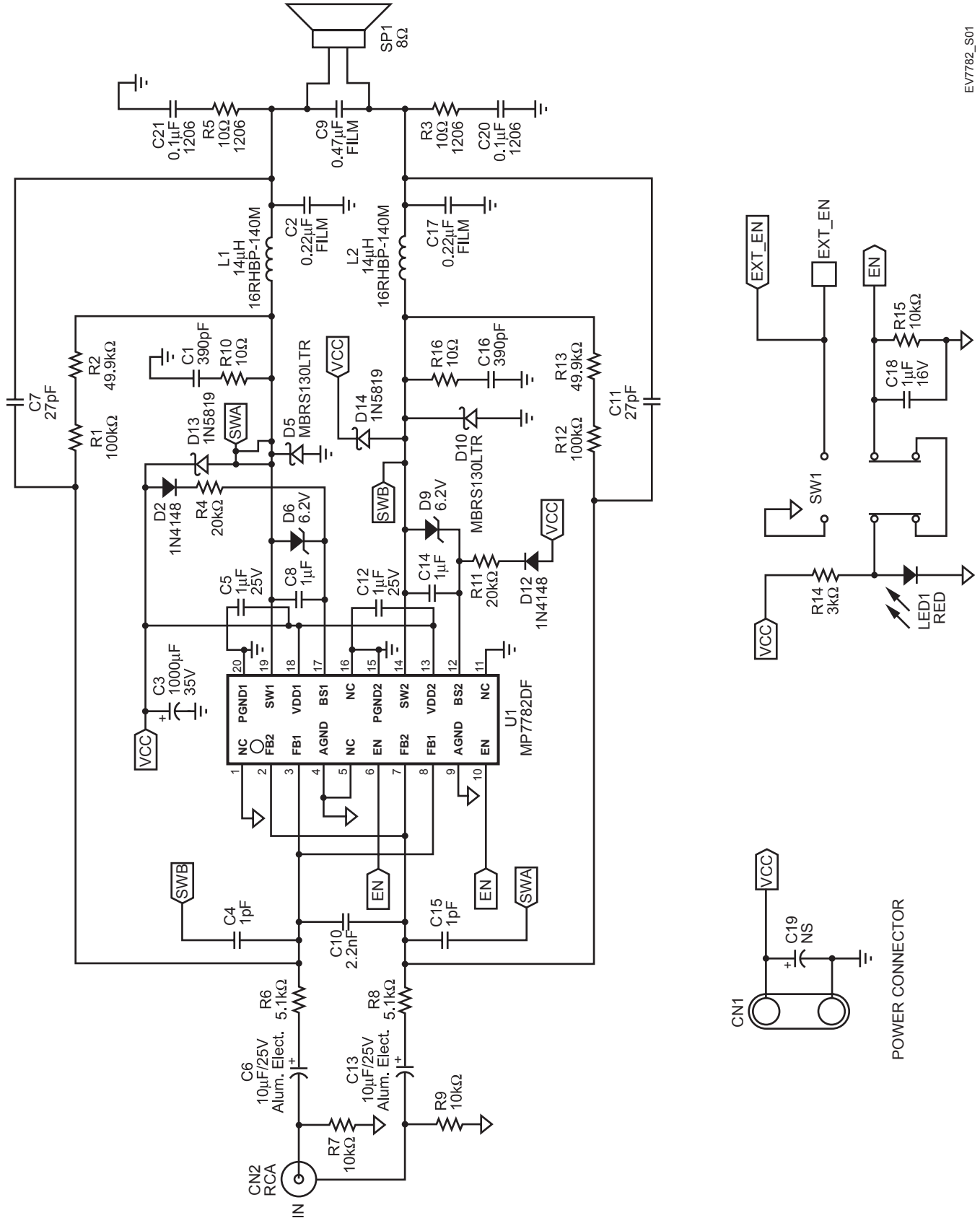

EV7782DF-00A BILL OF MATERIALS

Qty	Ref	Value	Description	Package	Manufacturer	Manufacturer P/N
2	C1, C16	390pF	Ceramic Capacitor, 50V, X7R	SM0603	Panasonic	ECU-V1H391KBV
2	C2, C17	0.22μF	Film Capacitor, 50V, Film	Radial	Panasonic	ECQ-V1H224JL
1	C3	1000μF	Electrolytic Capacitor 35V, NHG	Radial	Panasonic	ECA-1VHG102
2	C4, C15	1pF	Ceramic Capacitor, 50V, NPO	SM0603	Panasonic	ECJ-1VC1H010C
2	C5, C12	1μF	Ceramic Capacitor, 25V, X7R	SM1206	TDK	C3216X7R1E105K
2	C6, C13	10μF	Electrolytic Capacitor, 25V	SMD	Panasonic	ECE-V1EA100SR
2	C7, C11	27pF	Ceramic Capacitor, 50V, NPO	SM0603	TDK	C1608C0G1H270J
2	C8, C14	1μF	Ceramic Capacitor, 25V, X7R	SM0805	TDK	C2012X7R1E105K
1	C9	0.47μF	Film Capacitor, 50V, Film	Radial	Panasonic	ECQ-V1H474JL
1	C10	2.2nF	Ceramic Capacitor, 50V, X7R	SM0603	TDK	C1608X7R1H222K
1	C18	1μF	Ceramic Capacitor, 16V, X5R	SM0603	TDK	C1608X5R1C105K
1	C19	NS	Not Stuffed			
2	C20, C21	0.1μF	Ceramic Capacitor, 50V, X7R	SM1206	Panasonic	ECJ-3VB1H104K
1	CN1		Banana Jacks, Red and Black			
1	CN2		RCA Jack, RA		CUI Inc	RCJ-012
2	D2, D12		Diode Switch, 75V, 200mW	SOD-323	Diodes Inc	1N4148WS-7
2	D5, D10		Schottky Diode, 30V, 1A	SMB	IR	MBRS130LTR
2	D6, D9		Zener Diode, 6.2V, 200mW	SOD-323	Diodes Inc	BZT52C6V2S-7
2	D13, D14		Diode Schottky, 40V, 1A	SOD-123	Diodes Inc	1N5819HW-7
2	L1, L2	14μH	Inductor, 4.9A	Radial	Toko	16RHBP-140M
1	LED1		Red Diff LED, Round	Radial	Panasonic	LN28RP
2	R1, R12	100kΩ	Film Resistor, 1%	SM0603	Panasonic	ERJ-3EKF1003V
2	R2, R13	49.9kΩ	Film Resistor, 1%	SM0603	Panasonic	ERJ-3EKF4992V
2	R3, R5	10Ω	Film Resistor, 5%	SM1206	Panasonic	ERJ-8GEYJ100V
2	R4, R11	20kΩ	Film Resistor, 5%	SM0603	Panasonic	ERJ-3GEYJ203V
2	R6, R8	5.1kΩ	Film Resistor, 1%	SM0603	Panasonic	ERJ-3GEYJ512V
3	R7, R9, R15	10kΩ	Film Resistor, 5%	SM0603	Panasonic	ERJ-3GEYJ103V
2	R10, R16	10Ω	Film Resistor, 5%	SM0603	Panasonic	ERJ-3GEYJ100V
1	R14	3kΩ	Film Resistor, 5%	SM1206	Panasonic	ERJ-8GEYJ302V
1	SP1		Speaker Terminal			
1	SW1		DPDT Slide Switch		E-Switch	EG2209A
1	U1		Class D Amplifier, 50W	TSSOP20	MPS	MP7782DF

PRINTED CIRCUIT BOARD LAYOUT

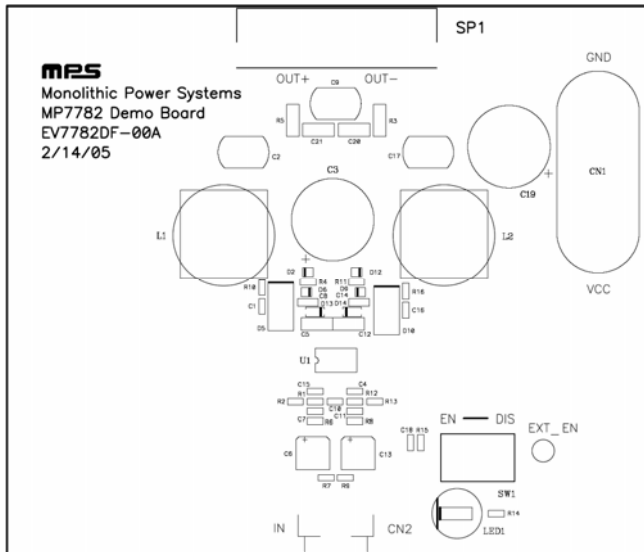

Figure 1—Top Silk Layer

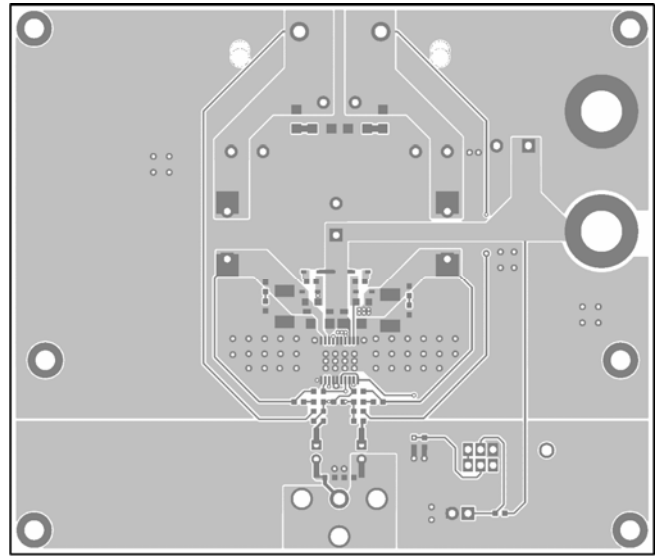

Figure 2—Top Layer

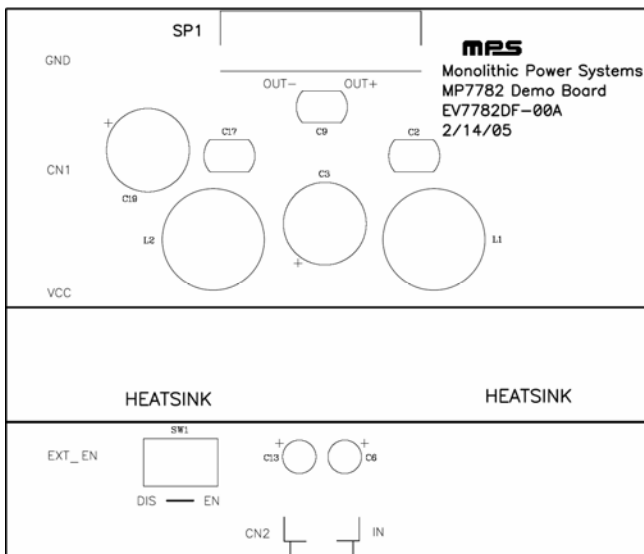

Figure 3—Bottom Silk Layer

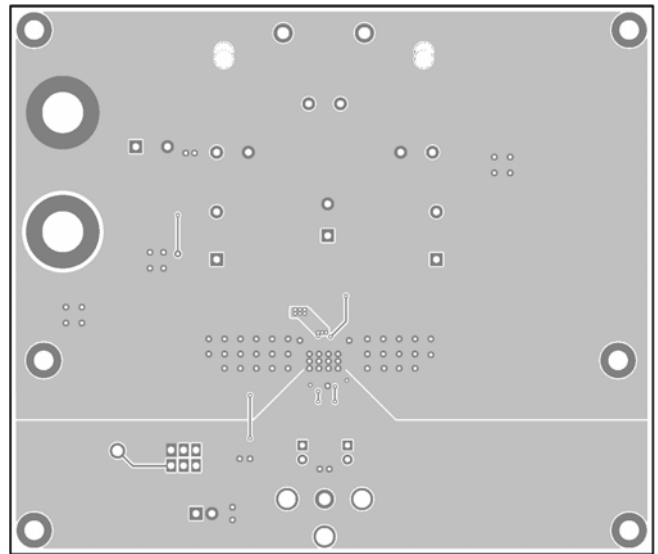

Figure 4—Bottom Layer

QUICK START GUIDE

This board is set up from the factory for 24V operation.

1. Power Requirements
 - a. Power supply: 24V
 - b. 0V to 1V_{RMS} (max) audio signal source.
 - c. Speaker: 6Ω minimum.
2. Setup Condition for 24V Operation
 - a. Connect the outputs to the external speakers.
 - b. Adjust the power supply to 24V, (do not turn on).
 - c. Connect the power supply to the V_{DD} terminals.
 - d. Set the enable switch to the DISABLE position.
 - e. Connect the audio input signal source to the amplifier inputs (IN1, IN2).
 - f. Turn on the power supply to apply power to the board.
3. Music Turn-On Sequence
 - a. Set the enable switch to the ENABLE position.
 - b. Audio should be heard from the speaker(s)
4. Music Turn-Off Sequence
 - a. Set the enable switch to the DISABLE position.

NOTICE: The information in this document is subject to change without notice. Please contact MPS for current specifications. Users should warrant and guarantee that third party Intellectual Property rights are not infringed upon when integrating MPS products into any application. MPS will not assume any legal responsibility for any said applications.