

## DESCRIPTION

The EV7742DF-00D is the evaluation board for the MP7742, a stereo 15W Class D Audio Amplifier. It is one of MPS' products of fully integrated audio amplifiers which dramatically reduces solution size by integrating the following:

- 250mΩ power MOSFETs
- Startup / Shutdown pop elimination
- Short circuit protection circuits

The MP7742 utilizes a single ended output structure capable of delivering 2x15W into 4Ω speakers. MPS Class D Audio Amplifiers exhibit the high fidelity of a Class A/B amplifier at high efficiency. The circuit is based on the MPS' AAM™ proprietary variable frequency topology that delivers excellent linearity, fast response time and operates on a single power supply.

## ELECTRICAL SPECIFICATIONS

Parameter	Symbol	Value	Units
Supply Voltage	$V_{DD}$	24	V

## FEATURES

- 15W Output at  $V_{DD} = 24V$  into a 4Ω load
- THD+N = 0.04% at 1W, 8Ω, 1kHz
- 90% Efficiency at 15W and  $V_{DD}=24V$  with 4Ω load
- Low Noise (103μV Typical)
- 9.5V to 28V Operation from a Single Supply

## APPLICATIONS

- Flat Panel TV
- Portable Docking Stations
- Surround Sound DVD Systems
- Televisions
- Multimedia Computers
- Home Stereo Systems

"MPS" and "The Future of Analog IC Technology" are Registered Trademarks of Monolithic Power Systems, Inc.

AAM (Analog Adaptive Modulation) is a Trademark of Monolithic Power Systems, Inc.

## EV7742DF-00D EVALUATION BOARD



(L x W x H) 3.5" x 2.4" x 1.2"  
8.9cm x 6.1cm x 3.0cm

Board Number	MPS IC Number
EV7742DF-00D	MP7742DF

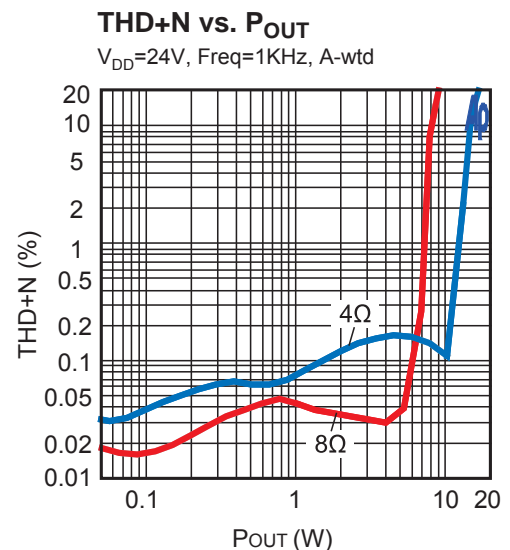

**EVALUATION BOARD SCHEMATIC**

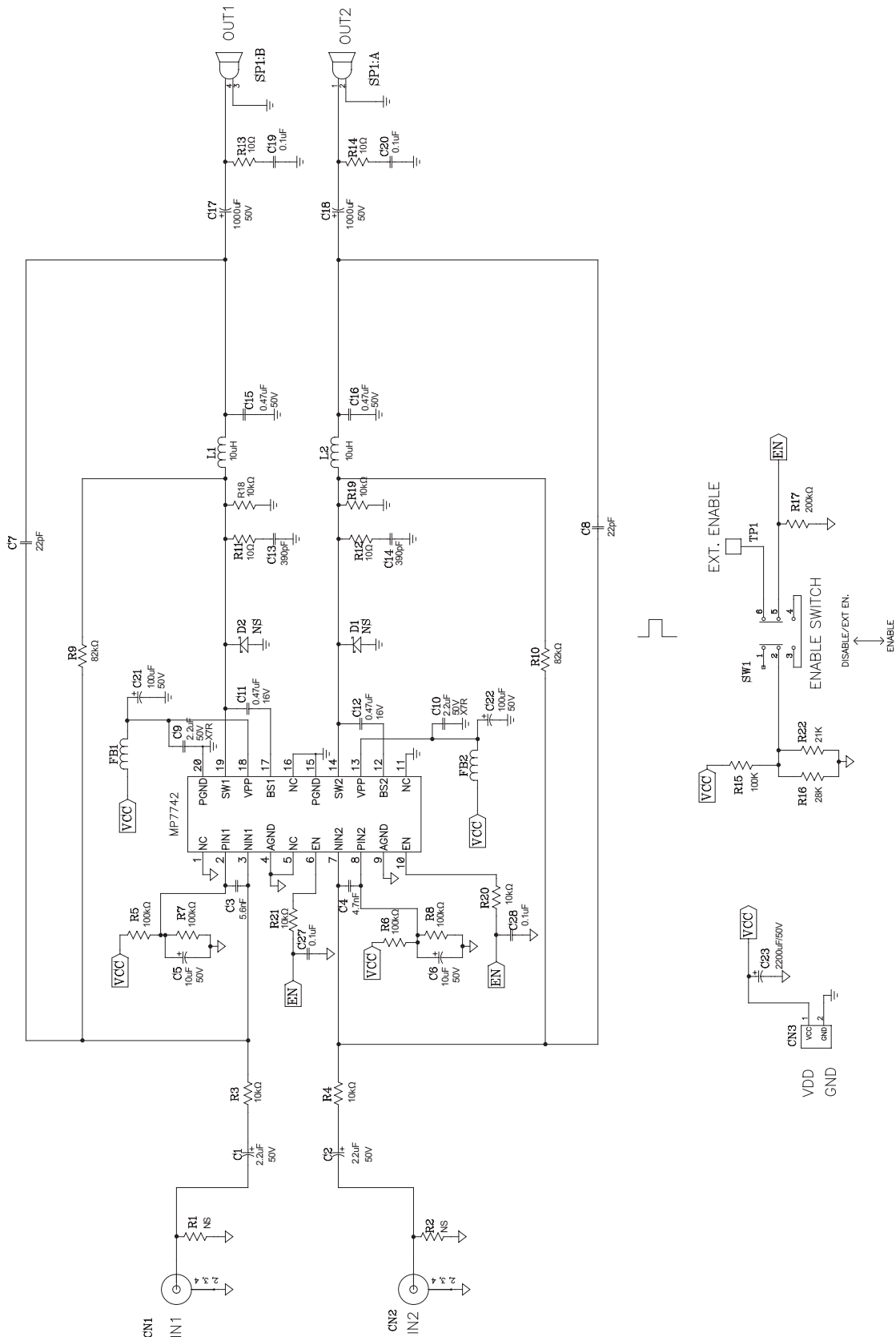

**EV7742DF-00D BILL OF MATERIALS**

Qty	Ref	Value	Description	Package	Manufacturer	Manufacturer P/N
2	C1, C2	2.2uF	Electrolytic Capacitor, 50V	Radial	Rubycon	
1	C3	5.6nF	Ceramic Capacitor, 50V, X7R	0603	muRata	GRM188R71H562KA01
1	C4	4.7nF	Ceramic Capacitor, 50V, X7R	0603	muRata	GRM188R71H472KA01D
2	C5, C6	10u	Electrolytic Capacitor, 50V	Radial	Rubycon	
2	C7, C8	22pF	Ceramic Capacitor, 50V, C0G	0603	muRata	GRM1885C1H220JA01D
2	C9, C10	2.2uF	Ceramic Capacitor, 50V, X7R	1206	muRata	GRM31CR71H225KA88L
2	C11, C12	0.47uF	Ceramic Capacitor, 16V, X7R	0603	muRata	GRM188R71C474KA88D
2	C13, C14	390pF	Ceramic Capacitor, 50V, C0G	0603	muRata	GRM1885C1H3901JA01
2	C15, C16	0.47uF	FILM, 50V	Radial	any	
2	C17,C18	1000uF	Electrolytic Capacitor, 50V	Radial	Rubycon	
4	C19, C20, C27, C28	0.1uF	Ceramic Capacitor, 50V, X7R	0603	muRata	GRM188R71H104KA93D
2	C21, C22	100uF	Electrolytic Capacitor, 50V	Radial	Rubycon	
1	C23	2200uF	Electrolytic Capacitor, 50V	Radial	Rubycon	
2	D1, D2,	NS	Diode Schottky, 40V, 1A			
2	FB1, FB2		Ferrite Bead, 6A	1206	LION	PB321611-320
1	SW1		DPDT Slide Switch			
2	CN1,CN2		Phone Jack, Female			
1	CN3		Banana Jack Connector			
1	TP1		Test Point/EXT.EN			
1	SP1		Speaker Connector			
2	L1, L2	10uH	Inductor, 3.61A	Radial	Toko	10RHBP-#A671HN-100L
2	R1,R2	NS				
6	R3, R4, R18, R19, R20, R21	10kΩ	Film Res., 1%	0603	Yageo	RC0603FR-0710KL
5	R5, R6, R7, R8, R15	100kΩ	Film Res., 1%	0603	Yageo	RC0603FR-07100KL
2	R9, R10	82.5kΩ	Film Resistor, 1%	0603	Yageo	RC0603FR-0782K5L
4	R11, R12, R13, R14	10Ω	Film Resistor, 5%	0603		0603SAJ0100T5E
1	R16	28kΩ	Film Resistor, 1%	0603	Yageo	RC0603FR-0728KL
1	R17	200kΩ	Film Resistor, 5%	0603	Yageo	RC0603JR-07200KL
1	R22	21kΩ	Film Resistor, 1%	0603	Yageo	RC0603FR-0721KL
1	U1		Class D Audio Amplifier	TSSOP20F	MPS	MP7742DF

## PRINTED CIRCUIT BOARD LAYOUT

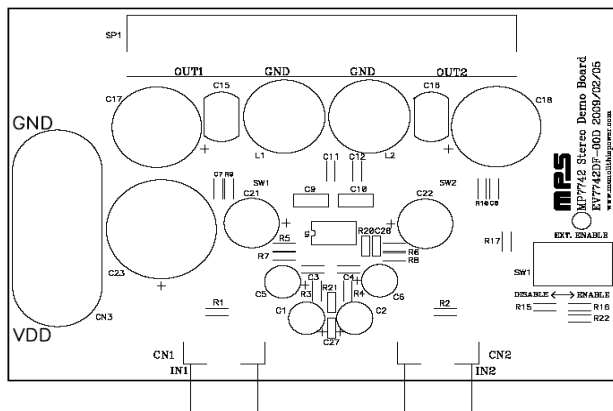

Figure 1—Top Silk Layer

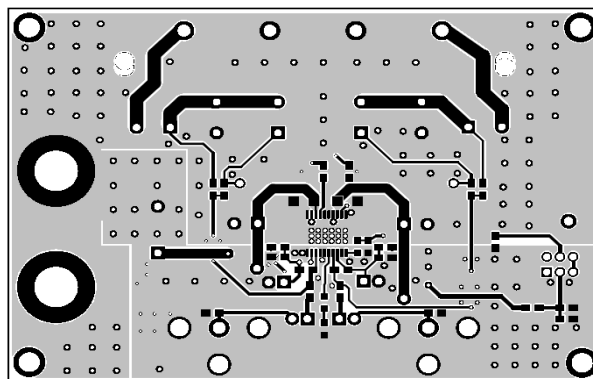

Figure 2—Top Layer

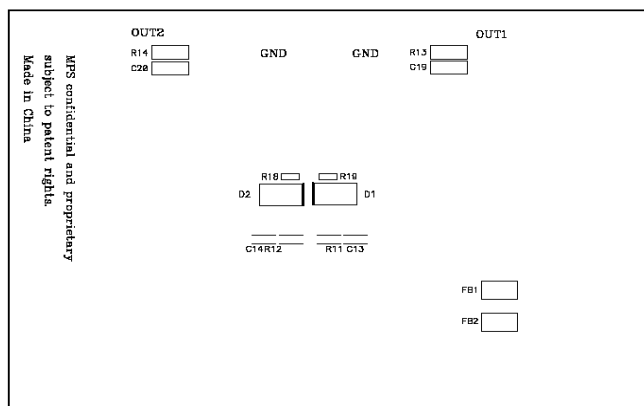

Figure 3—Bottom Silk Layer

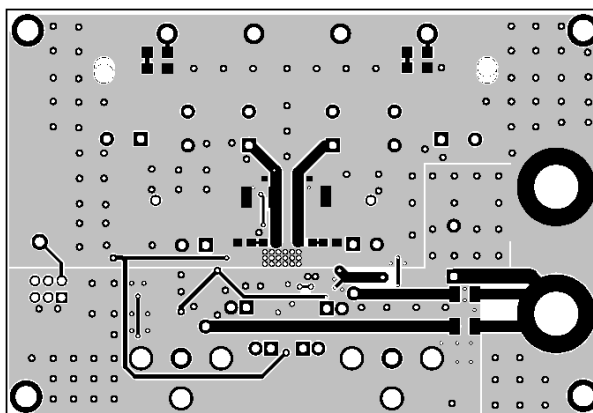
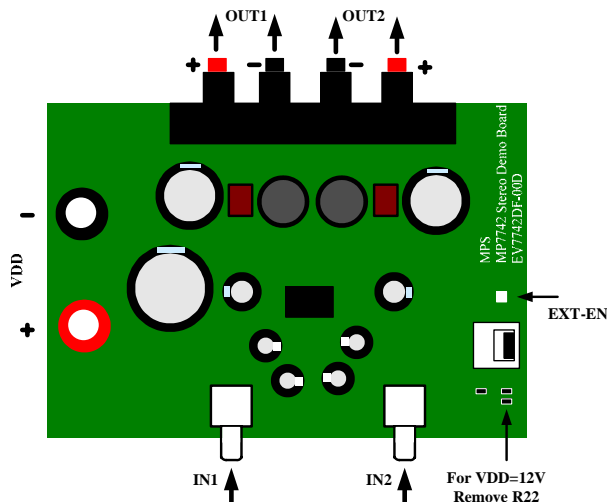

Figure 4—Bottom Layer

## QUICK START GUIDE

This board set up from the factory for 24V operation. To use with a 12V power supply, adjust the components as specified in the 12V Operation Modifications section below. For more information, consult the MP7742 datasheet.



**Figure 5—EV7742DF-00D Connection Diagram**

1. Power Requirements
  - a. Power supply: 9.5V to 28V, 3.5A maximum.
  - b. 0V to 1.3V<sub>RMS</sub> (max) audio signal source.
  - c. Speaker: 4Ω to 8Ω.
2. Setup Condition for 24V Operation
  - a. Adjust the power supply to 24V (do not turn on).
  - b. Connect the outputs to the external speakers.
  - c. Connect the power supply to the V<sub>DD</sub> terminals.
  - d. Set the enable switch to the DISABLE position.
  - e. Connect the audio input signal source to the amplifier inputs (IN1, IN2).
  - f. Turn on the power supply to apply power to the board.
3. 12V Operation Modifications
  - a. Change C3 to 3.3nF and C4 to 2.2nF components.
  - b. Remove R22 from the demo board.
  - c. Adjust the power supply to 12V (do not turn on).
  - d. Do as step b~f specified in Section 2.
4. Music Turn-On Sequence
  - a. Set the enable switch to the ENABLE position.
5. Music Turn-Off Sequence
  - a. Set the enable switch to the DISABLE position.
  - b. Turn off power supply.

**NOTICE:** The information in this document is subject to change without notice. Please contact MPS for current specifications. Users should warrant and guarantee that third party Intellectual Property rights are not infringed upon when integrating MPS products into any application. MPS will not assume any legal responsibility for any said applications.