



EV7221-R-00A

16-Channel, 80mA/Ch, LED Driver with with Separated PWM Analog Dimming and I²C Evaluation Board

DESCRIPTION

The EV7221-R-00A evaluation board is designed to demonstrate the capabilities of the MPQ7221-AEC1. The MPQ7221 is a 16-channel LED driver that can operate across a wide 4V to 16V input voltage range. The MPQ7221 applies 16 internal current sources in each LED string terminal. The LED current of each channel is set by an external current-setting resistor. The maximum current of each channel is 80mA.

The MPQ7221 integrates an I²C interface. Ten different I²C addresses are programmable via an external resistor, which allows the MPQ7221 to support up to 10 cascaded ICs to drive an LED array. Each channel can be enabled or disabled via the I²C. The MPQ7221 employs separated PWM dimming and analog dimming for each LED channel, as well as 12-bit resolution PWM dimming and 6-bit analog dimming for each channel. The LED current ramp rate and phase shift can be programmed to minimize electromagnetic interference (EMI).

The MPQ7221 can output a configurable refresh signal from the RFSH/FLT pin.

The driver integrates open-load protection (OLP), short-load protection (SLP), and over-temperature protection (OTP). The fault indicator pulls low when any protection is triggered, and the corresponding fault register is set.

The MPQ7221 is AEC-Q100 qualified, and is available in a QFN-24 (4mmx4mm) package with wettable flanks.

ELECTRICAL SPECIFICATIONS

| Parameter | Symbol | Value | Units |
|--------------------|------------------|--------------------------|-------|
| Input voltage | V _{IN} | 4 to 16 | V |
| LED strings | | 16 | |
| Output voltage | V _{LED} | < V _{IN} - 0.5V | V |
| LED current/string | I _{LED} | 80 | mA |

FEATURES

- Wide 4V to 16V Input Voltage Range
- 16 Channels, 80mA/Channel Max
- LED Current Programmed by External Resistor
- 6-Bit Analog Dimming for Each Channel
- 12-Bit PWM Dimming for Each Channel
- Selectable PWM Dimming Frequency (220Hz, 250Hz, 280Hz, or 330Hz)
- Refresh Signal Output
- I²C Interface
- 10 Addresses Programmable via an External Resistor
- LED Current Slew Rate Programmable
- Phase Shift (40μs)
- Fault Indicator
- LED Open Protection
- LED Short Protection, Programmable Threshold
- Under-Voltage Lockout (UVLO)
- Over-Temperature Protection (OTP)
- Available in a QFN-24 (4mmx4mm) Package
- Available in Wettable Flank Package
- Available in AEC-Q100 Grade1

APPLICATIONS

- Automotive Tail Lights
- Automotive Turning Lights

All MPS parts are lead-free, halogen-free, and adhere to the RoHS directive. For MPS green status, please visit the MPS website under Quality Assurance. "MPS", the MPS logo, and "Simple, Easy Solutions" are trademarks of Monolithic Power Systems, Inc. or its subsidiaries.

EV7221-R-00A EVALUATION BOARD

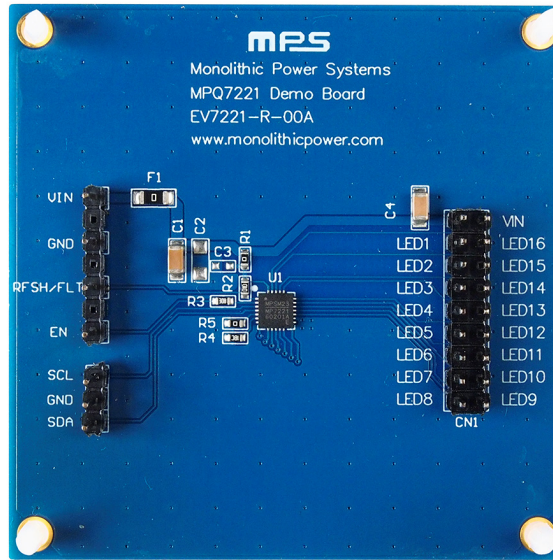

(LxWxH) 6.35cmx6.35cmx2cm

| Board Number | MPS IC Number |
|--------------|-----------------|
| EV7221-R-00A | MPQ7221GRE-AEC1 |

QUICK START GUIDE

1. Connect a voltage source between 4V and 16V between the VIN terminal and GND on the board. Ensure that the input voltage (V_{IN}) is at least 0.5V above V_{LED} at all times.
2. Connect the LED load terminals to:
 - a. Positive (+): LED+
 - b. Negative (-): LED1~16
3. Use an external DC source to drive EN above 2.1V to enable the board.
4. Connect the SCL, SDA, and GND pins on the board to the SCL, SDA, and GND of a programmable kit (EVKT-USBI2C-02) with I²C interface, respectively (see Figure 1).

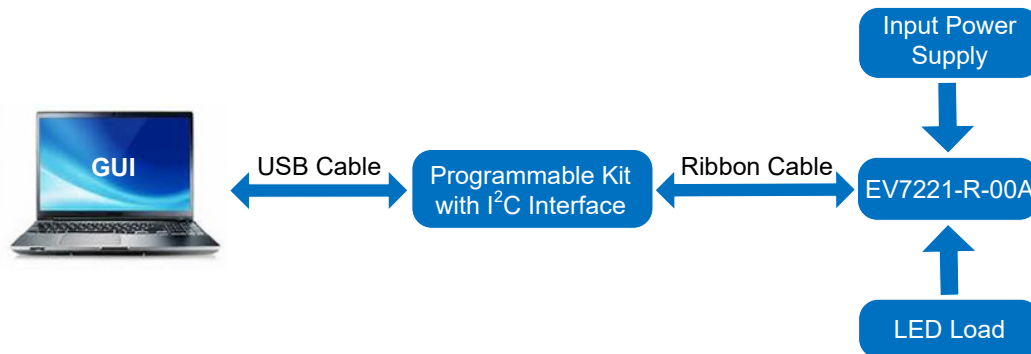

Figure 1: I²C Connection Diagram

5. To start up the board:
 - a. Enable VIN.
 - b. Enable EN.
 - c. Establish the I²C connection so that the microcontroller can communicate with the IC.
 - d. Pull EN high (to lighten the LED load).
6. The LED current (I_{LED}) is set by the external resistor (R_{ISET}). Each channel's I_{LED} can be calculated with Equation (1):

$$I_{LED} \text{ (mA)} = \frac{1200}{R_{ISET} \text{ (k}\Omega\text{)}} \quad (1)$$

EVALUATION BOARD SCHEMATIC

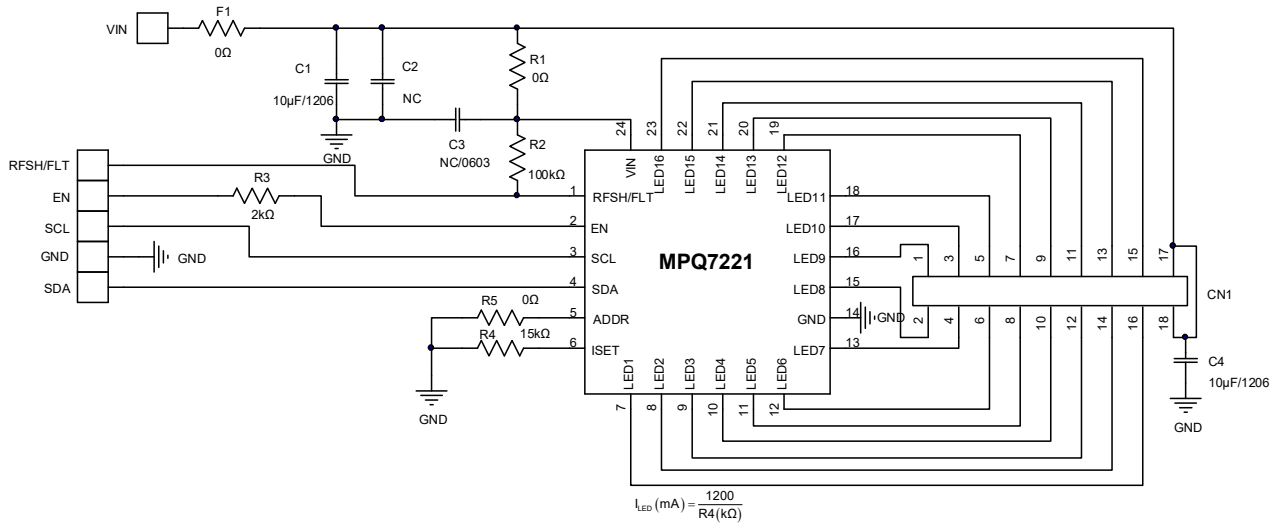
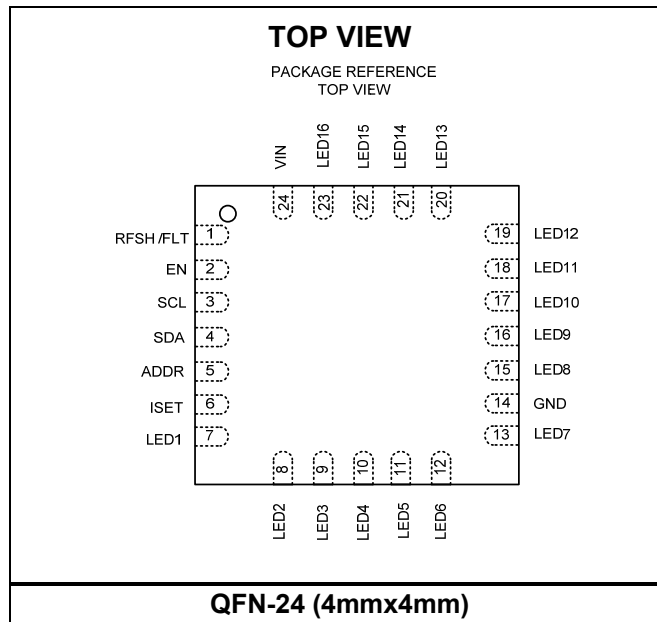

Figure 2: Evaluation Board Schematic

PACKAGE REFERENCE



EV7221-R-00A BILL OF MATERIALS

| Qty | Ref | Value | Description | Package | Manufacturer | Manufacturer PN |
|-----|----------------------------------|---------|--|------------------|--------------|-------------------|
| 2 | C1, C4 | 10μF | Capacitor, 25V, X7R | 1206 | Murata | GRM31CR71E106KA12 |
| 1 | C2 | NC | | 0805 | | |
| 1 | C3 | NC | | 0603 | | |
| 1 | F1 | 0Ω | Resistor, 1% | 1206 | Yageo | RC1206FR-070RL |
| 2 | R1, R5 | 0Ω | Resistor, 1% | 1206 | Yageo | RC0603FR-070RL |
| 1 | R2 | 100kΩ | Resistor, 1% | 0603 | Yageo | RC0603FR-07100KL |
| 1 | R3 | 2kΩ | Resistor, 1% | 0603 | Yageo | RC0603FR-072KL |
| 1 | R4 | 15kΩ | Resistor, 1% | 0603 | Yageo | RC0603FR-0715KL |
| 1 | CN1 | 2.54mm | 18-pin header, test pin | DIP | Custom | |
| 7 | VIN, EN, GND, RFSH/FLT, SCL, SDA | 2.54mm | 1-pin header, test pin | DIP | Custom | |
| 1 | U1 | MPQ7221 | 16-channel, LED driver with I ² C and separate PWM and analog dimming | QFN-24 (4mmx4mm) | MPS | MPQ7221GRE-AEC1 |

EVB TEST RESULTS

V_{IN} = 4.5V, 16P1S (V_{LED} = 3V), I_{LED} = 80mA/string, T_A = 25°C, unless otherwise noted.

Steady State

V_{IN} = 4.5V, 16P1S, 80mA/string

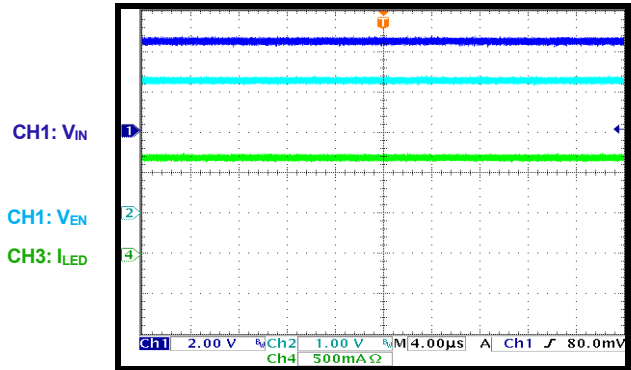

Start-Up through EN

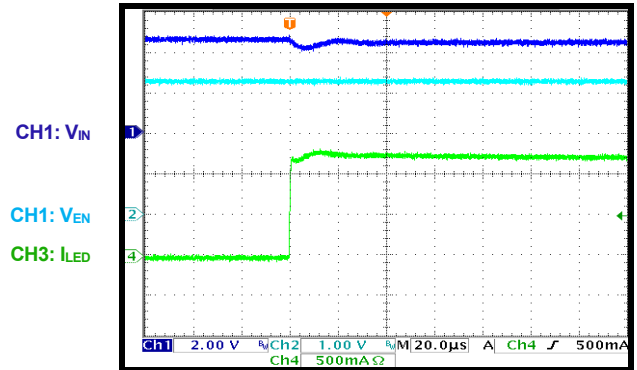

Shutdown through EN

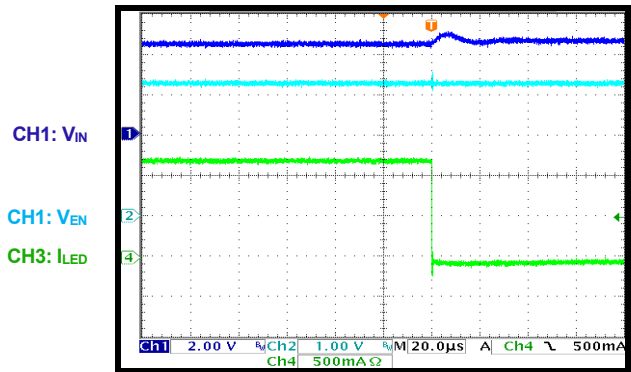

Analog Dimming

50mA/string

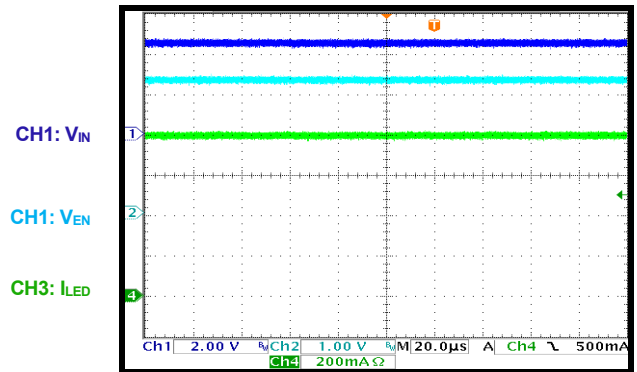

Analog Dimming

2.5mA/string

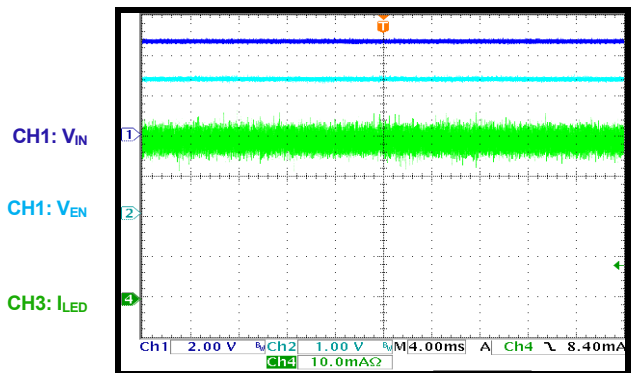

PWM Dimming

PWM duty = 50%

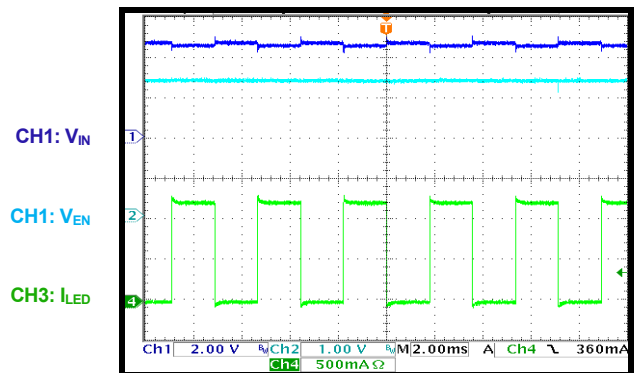

EVB TEST RESULTS (continued)

$V_{IN} = 4.5V$, 16P1S ($V_{LED} = 3V$), $I_{LED} = 80mA/string$, $T_A = 25^\circ C$, unless otherwise noted.

PWM Dimming

PWM duty = 0.5%

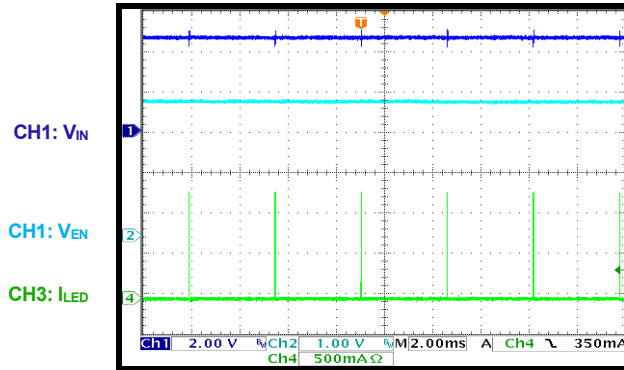

Slew Rate

PWM dimming, slew rate = $5\mu s$

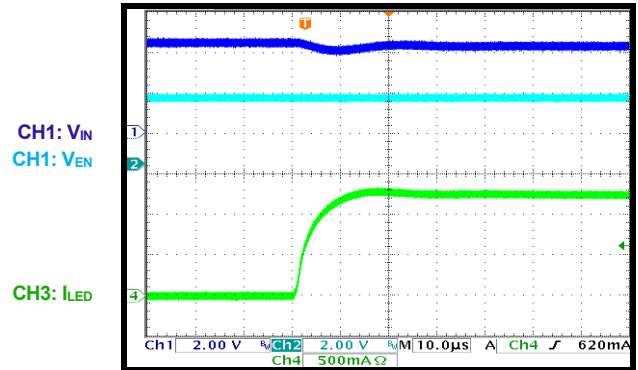

Phase Shift

PWM dimming, duty = 20%

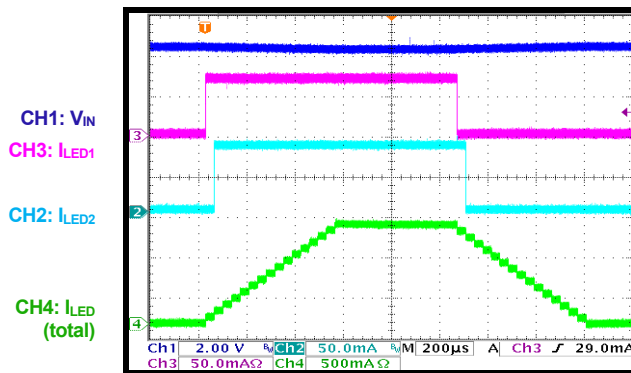

Refresh Function

$f_{PWM} = 250Hz$, RFRSH = 0x1FF

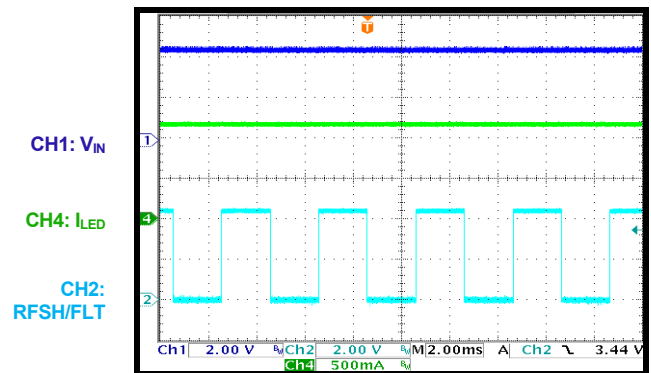

Short LEDx Entry

RFSH/FLT fault enable, $f_{PWM} = 250Hz$, RFRSH = 0x1FF

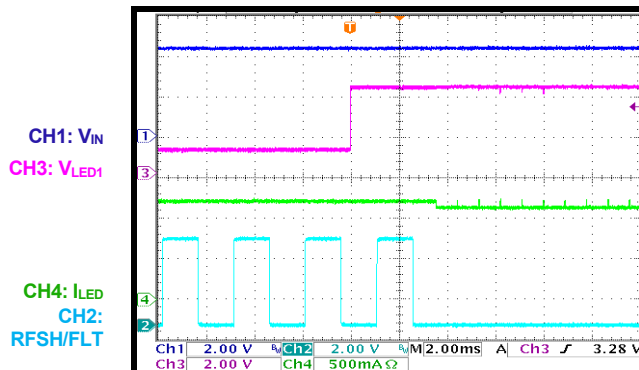

Short LEDx Recovery

RFSH/FLT fault enable, $f_{PWM} = 250Hz$, RFRSH = 0x1FF

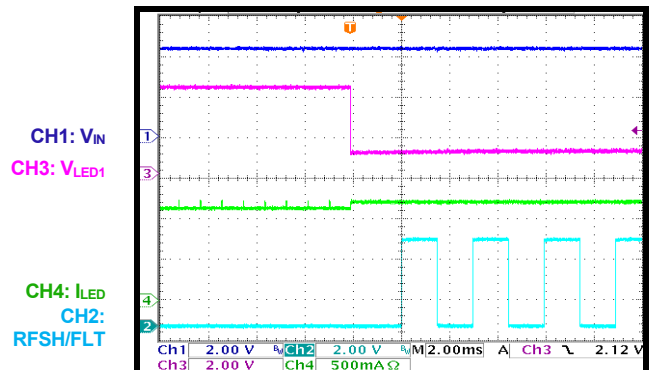

EVB TEST RESULTS (continued)

V_{IN} = 4.5V, 16P1S (V_{LED} = 3V), I_{LED} = 80mA/string, T_A = 25°C, unless otherwise noted.

Short LEDx Entry

RFSH/FLT fault enable, f_{PWM} = 250Hz,
RFRSH = 0x000

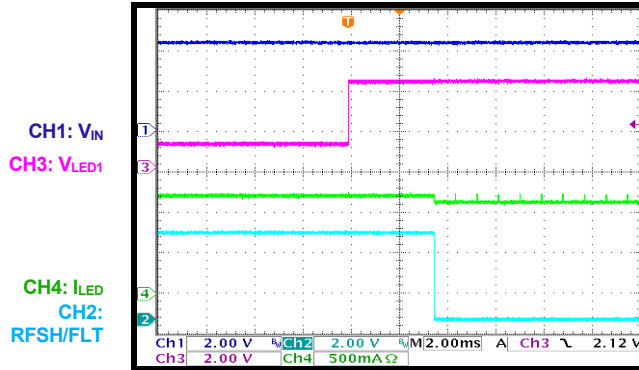

Short LEDx Recovery

RFSH/FLT fault enable, f_{PWM} = 250Hz,
RFRSH = 0x000

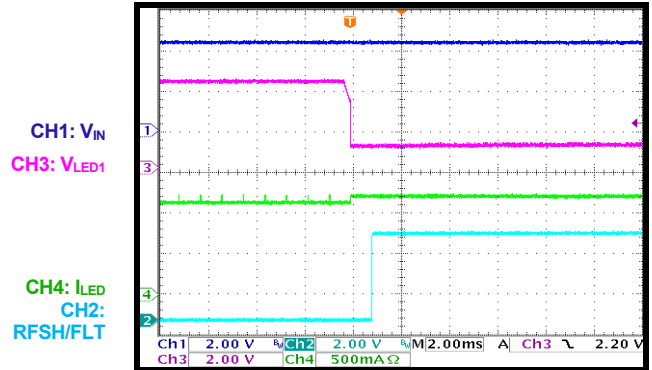

Open LEDx Entry

RFSH/FLT fault enable, f_{PWM} = 250Hz,
RFRSH = 0x1FF

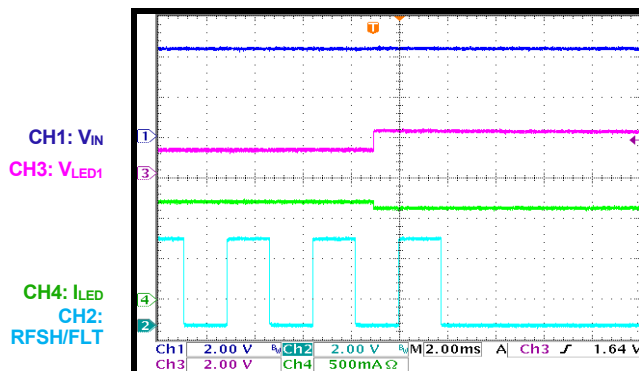

Open LEDx Recovery

RFSH/FLT fault enable, f_{PWM} = 250Hz,
RFRSH = 0x1FF

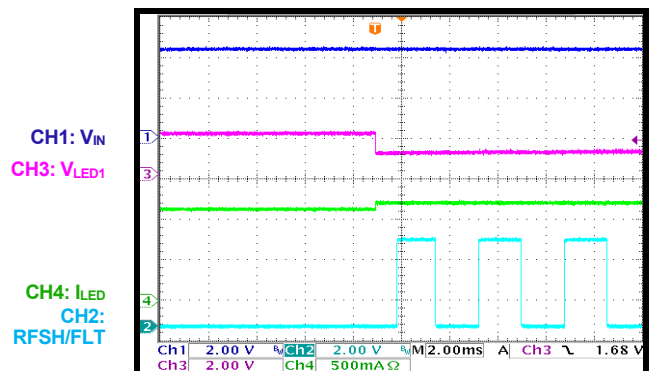

Open LEDx Entry

RFSH/FLT fault enable, f_{PWM} = 250Hz,
RFRSH = 0x000

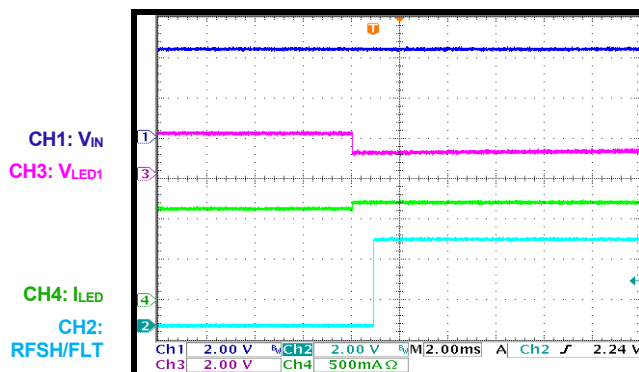

Open LEDx Recovery

RFSH/FLT fault enable, f_{PWM} = 250Hz,
RFRSH = 0x000

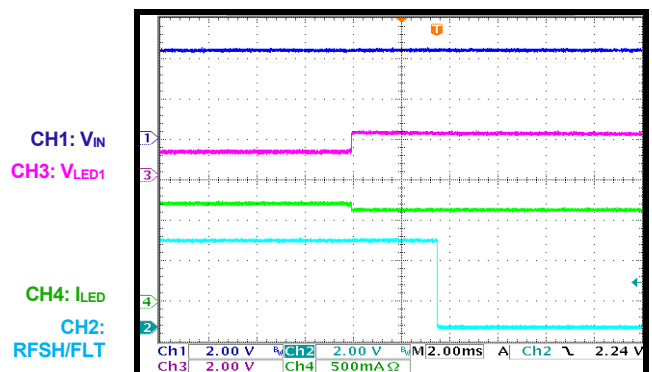

PCB LAYOUT

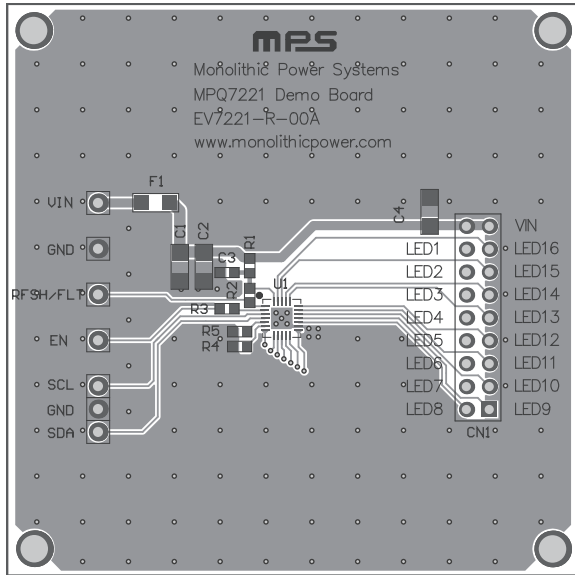

Figure 3: Top Silk and Top Layer

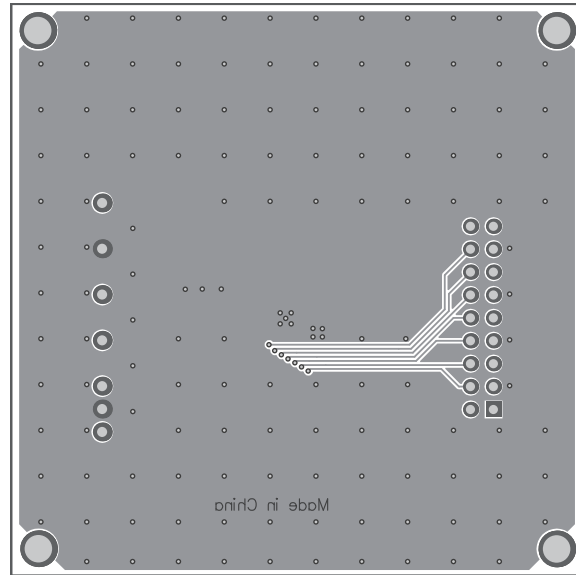

Figure 4: Bottom Layer and Bottom Silk



REVISION HISTORY

| Revision # | Revision Date | Description | Pages Updated |
|------------|---------------|-----------------|---------------|
| 1.0 | 4/16/2021 | Initial Release | - |

Notice: The information in this document is subject to change without notice. Please contact MPS for current specifications. Users should warrant and guarantee that third-party Intellectual Property rights are not infringed upon when integrating MPS products into any application. MPS will not assume any legal responsibility for any said applications.