

### DESCRIPTION

The MP6914 is an ideal diode for solar panel bypass application. It integrates a 30V, 5.5mΩ power MOSFET which will be turned on to conduct a current up to 10A when the corresponding photovoltaic panel is shaded to act as a consuming load. When the shade is released and the panel starts to produce energy, the MOSFET will be turned off. The power loss can be significantly reduced with the MP6914 due to its low voltage drop and low reverse leakage current. The part is available with SOIC8-EP package.

### ELECTRICAL SPECIFICATIONS

Parameter	Symbol	Value	Units
Supply Voltage	V <sub>DD</sub>	6 -24	V
Bypass Current	V <sub>F</sub>	0-10	A

### FEATURES

- Integrated 5.5mΩ 30V Power Switch
- Very Low Reverse Leakage Current
- Rugged Design for Long Lifetime
- SOIC8-EP

### APPLICATIONS

Bypass diode for photovoltaic panels

All MPS parts are lead-free and adhere to the RoHS directive. For MPS green status, please visit MPS website under Products, Quality Assurance page.

"MPS" and "The Future of Analog IC Technology", are Registered Trademarks of Monolithic Power Systems, Inc.

ADAM (Analog Digital Adaptive Modulation) is Trademarks of Monolithic Power Systems, Inc.

### EV6914DN-00A EVALUATION BOARD

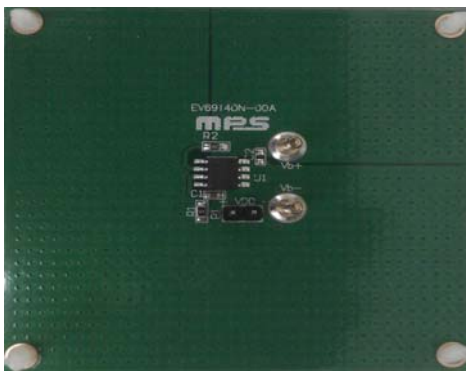

LxW (1.2" X 1.2")

Board Number	IC Number
EV6914DN-00A	MP6914DN

Max. I<sub>F</sub> vs. Temperature

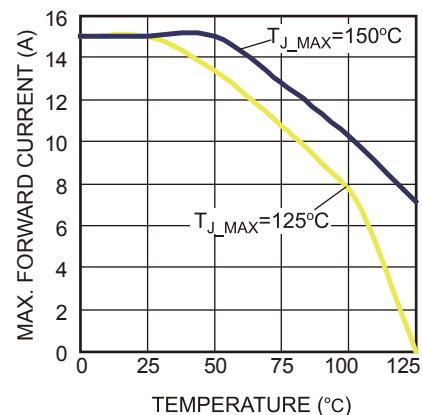

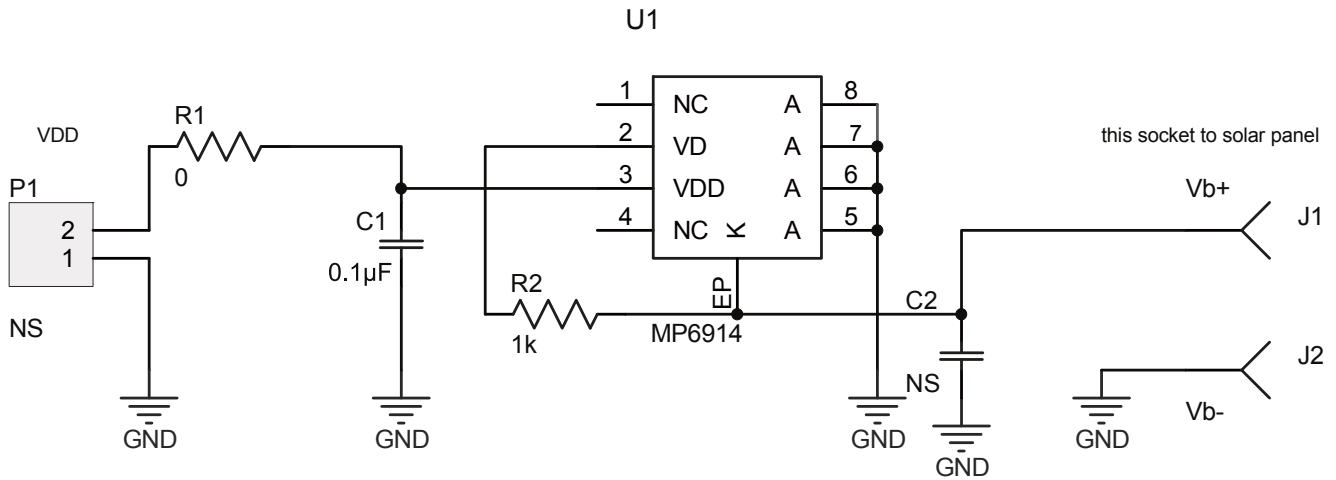
**EVALUATION BOARD SCHEMATIC**

**EV6914DN-00A BILL OF MATERIALS**

Quantity	Designator	Value	Description	Manufacturer	Manufacturer P/N	Package
1	C1,	0.1µF	50V ceramic CAP	TDK	C1608X7R1H104K	0603
0	C2	NS				0603
1	J1	Vb+	2mm Cu pin			DI
1	J2	Vb-	2mm Cu pin			DI
1	P1	NS	Header, 2-Pin			DIP-2
2	R1, R2	0	5% film resistor	YAGEO	RC0805JR-070RL	0805
1	R3	1k	5% film resistor	YAGEO	RC0805JR-071KL	0805
1	U1	MP6914	ideal diode	MPS	MP6914DN	SOIC8E

### EVB TEST RESULTS

Performance waveforms are tested on the evaluation board.

$V_{DD} = 12V$ ,  $I_{AK} = 10A$ ,  $T_A = 25^\circ C$ , unless otherwise noted.

**Forward Voltage vs. Forward Current**

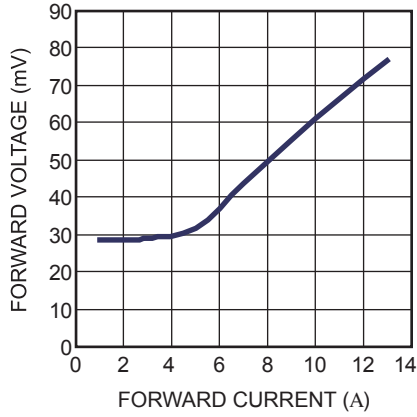

**Forward Power Dissipation**

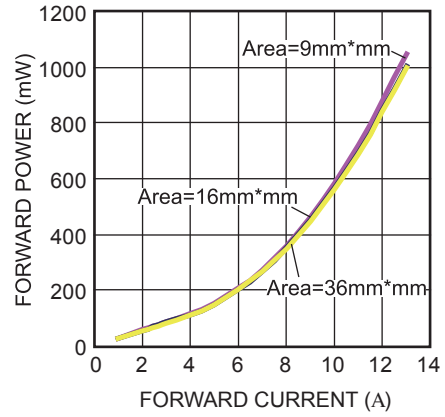

**V<sub>DD</sub> Power On**

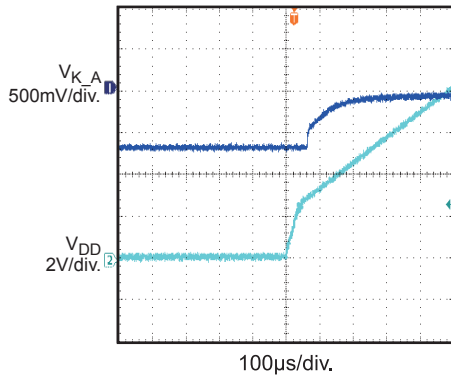

**V<sub>b</sub> Power On**

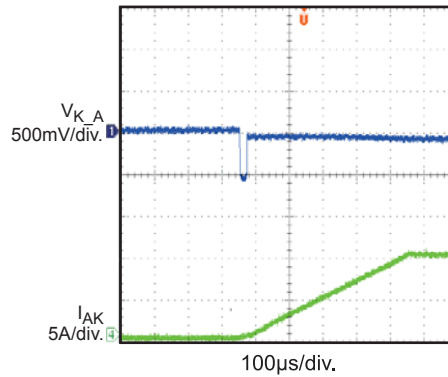

### PRINTED CIRCUIT BOARD LAYOUT

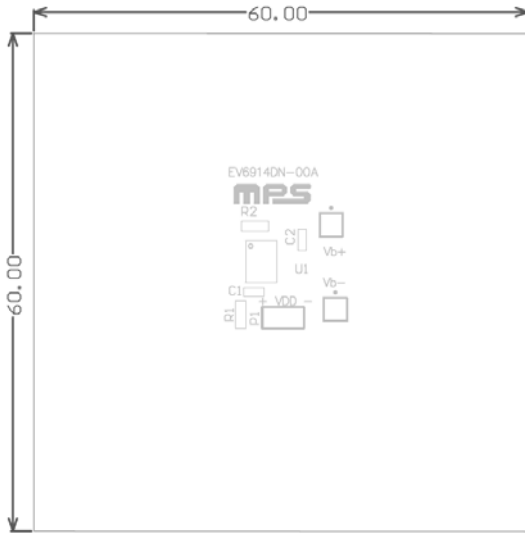

Top Silk Layer

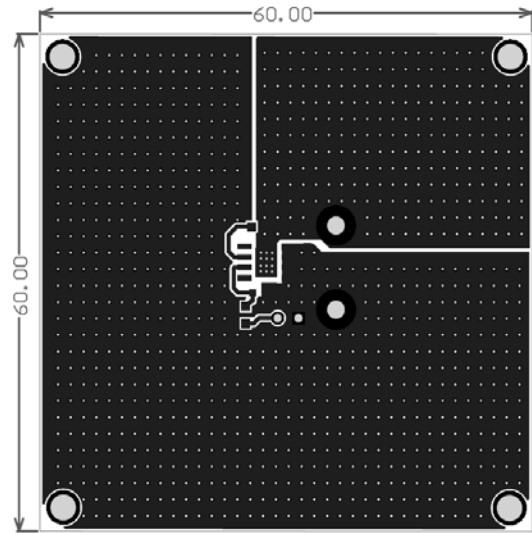

Top Layer

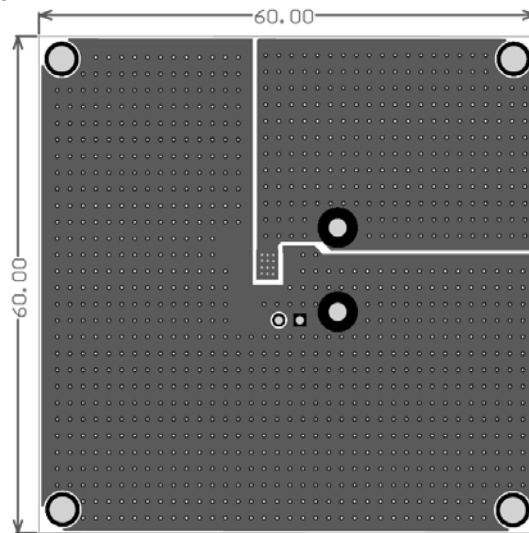

Bottom Layer

## QUICK START GUIDE

$V_{DD}$  is the power supply for MP6914's internal control circuit and  $V_{b+}$ ,  $V_{b-}$  are the ports which should be connected to positive and negative of photovoltaic battery, respectively. The photovoltaic battery should have a load within 0-10A range. If a power supply is used to simulate the photovoltaic battery,  $V_{b+}$  and  $V_{b-}$  should be connected to the power with current limited to absolute value 0-10A, regardless of the port polar. Assume the latter method used to evaluate MP6914:

1. Preset the  $V_{DD}$  power supply between 6V and 24V, and turn off the power supply.
2. Connect the positive and negative terminals of the  $V_{DD}$  power supply to the  $V_{DD}$  and GND pins on the board, respectively.
3. Connect the photovoltaic battery emulate power to  $V_{b+}$  and  $V_{b-}$ , regardless of the polar.
  - If connect the pos. of emulate power to  $V_{b+}$  and the neg. of emulate power to  $V_{b-}$  to simulate a solar panel in normal work, the internal MOSFET will be turned off.
  - If connect the pos. of emulate power to  $V_{b-}$  and the neg. of emulate power to  $V_{b+}$  with current limited to 0-10A to simulate a shaded solar panel which consumes energy from other solar panels, the internal MOSFET will be turned on.
4. Turn on the  $V_{DD}$  power supply.

**NOTICE:** The information in this document is subject to change without notice. Users should warrant and guarantee that third party Intellectual Property rights are not infringed upon when integrating MPS products into any application. MPS will not assume any legal responsibility for any said applications.