



The Future of Analog IC Technology®

EV6412-QGU-00A

Ultra Low I_q Load Switch Controller

with RESET Timer for Mobile Evaluation Board

DESCRIPTION

The MP6412 is a load switch controller to turn on/off main power P-channel MOSFET. It covers 2.2V to 12V operating voltage range. With the tiny package, MP6412 provides very space saving solution in smart phone and tablet or other portable devices application.

The MP6412 equipped reset and power sequence function with the factory-programmable delay timer. The reset and power sequence is controlled by RST0/RST1 and OFF signal. For mobile application, MP6412 also has a system discharge path and Charger insert detect feature.

Tiny 10 pins UTQFN 1.4mmx1.8mm of MP6412 is available in space saving package.

ELECTRICAL SPECIFICATION

Parameter	Symbol	Value	Units
Input Voltage	V _{IN}	2.2-12	V
Output Current	I _{OUT}	1.5	A

FEATURES

- VIN Range from 2.2V to 12V
- PMOS Gate Driver
- Auto 300Ω Output Discharge
- 2μA Quiescent Current
- <1μA Shipping Mode Current
- Factory Fixed Reset Delay
- ESD HBM 2kV
- Small UTQFN 1.4mmx1.8mm Package for Space Saving

APPLICATIONS

- Mobile Phone
- Portable/Handheld Devices
- Wearable Device

All MPS parts are lead-free, halogen-free, and adhere to the RoHS directive. For MPS green status, please visit the MPS website under Quality Assurance.

“MPS” and “The Future of Analog IC Technology” are registered trademarks of Monolithic Power Systems, Inc..

TYPICAL APPLICATION

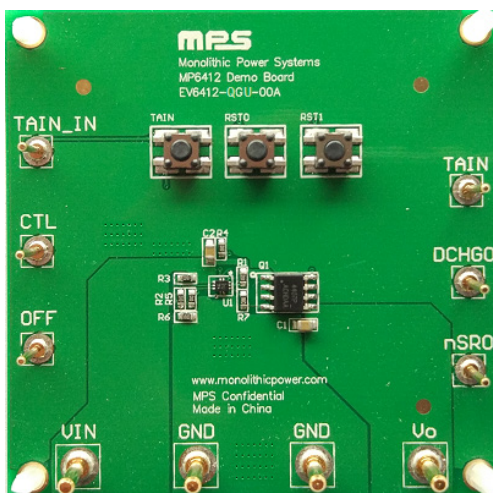

Board Number	MPS IC Number
EV6412-QGU-00A	MP6412GQGU

EVALUATION BOARD SCHEMATIC

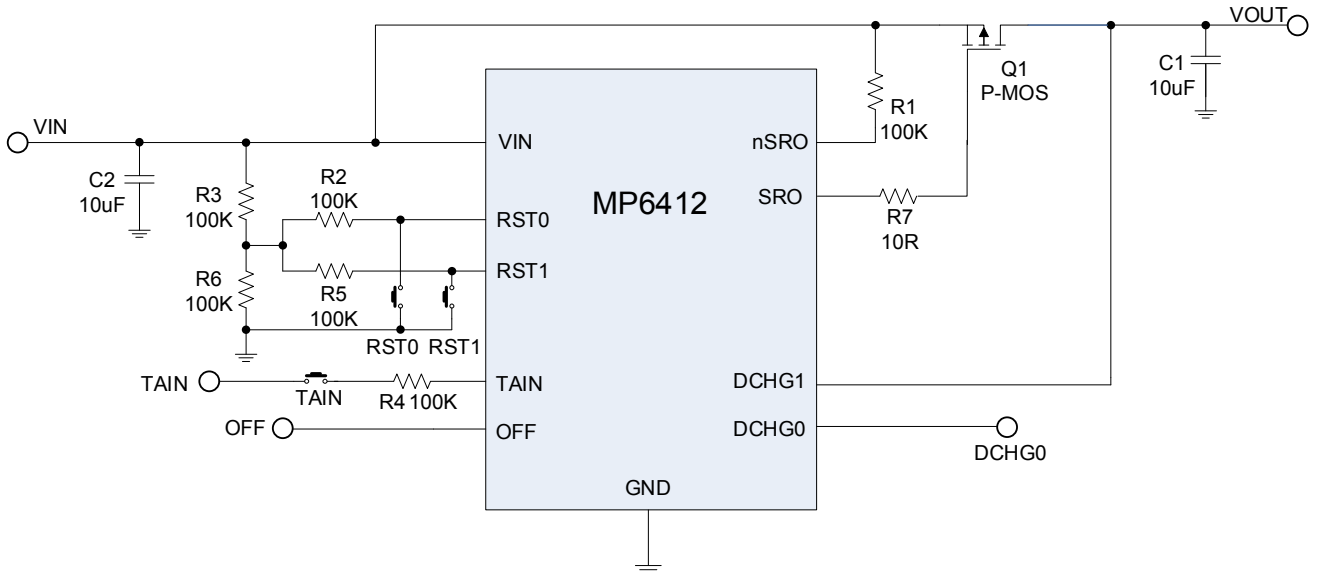

Figure 1—Typical Application Circuit for MP6412

EV6412-QGU-00A BILL OF MATERIALS

Qty	RefDes	Value	Description	Package	Manufacturer	Manufacturer P/N
2	C1, C2	10uF	Ceramic Cap,6.3V,X5R	0805	muRata	GRM188R60J106ME47D
6	R1, R2, R3, R4, R5, R6	100K	Film Res,1%	0603	muRata	GRM21BR61A226ME51L
1	R7	10	Film Res,1%	0603	ROYAL	RL0603FR-0710KL
1	Q1	AM4407P	MOSFET, -30V, 13mΩ	SO-8	Analog Power	AM4407P
3	RST0, RST1, TAIN		Push button	SO-4	Stand	Stand
1	U1	MP6412	Low IQ load switch controller	QFN10	MPS	MP6412GQGU

TYPICAL PERFORMANCE CHARACTERISTICS

$V_{IN} = 3.6V$, $T_A = 25^{\circ}C$, unless otherwise noted.

Reset Function

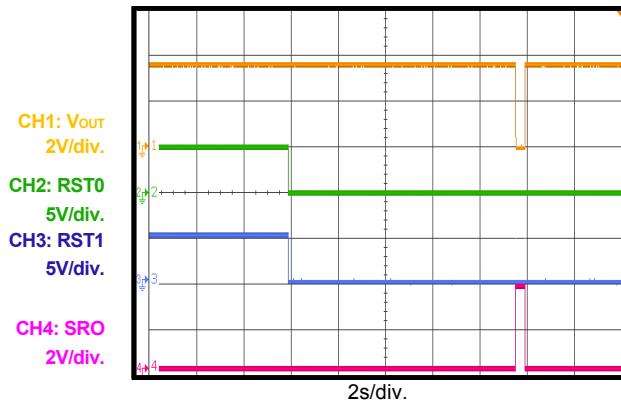

Reset Function (RST1 First)

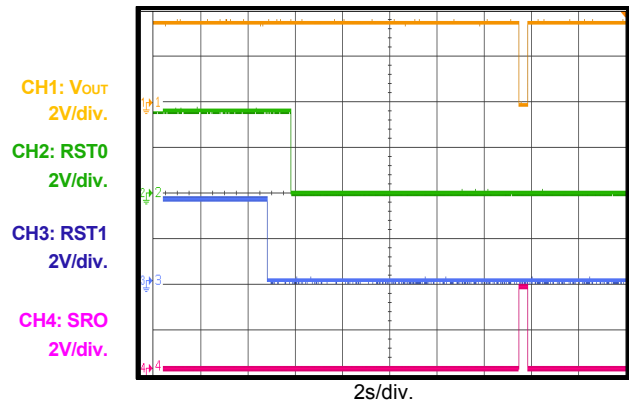

Reset Function (RST0 First)

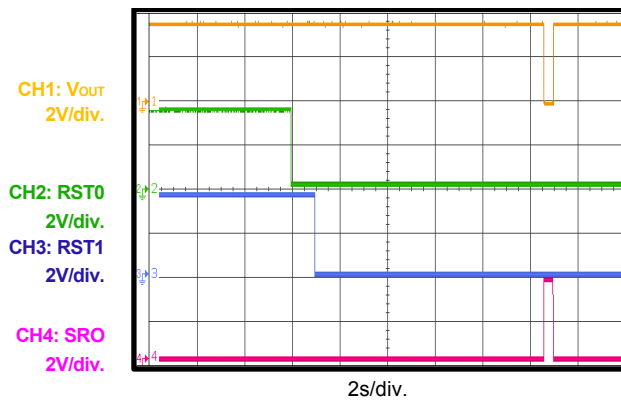

Shipping Mode Enter

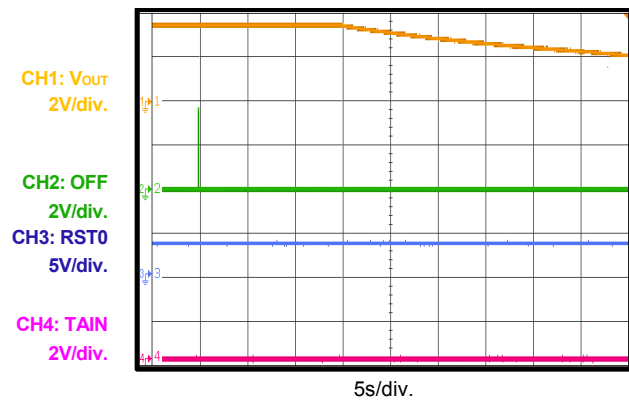

Shipping Exit with Tain

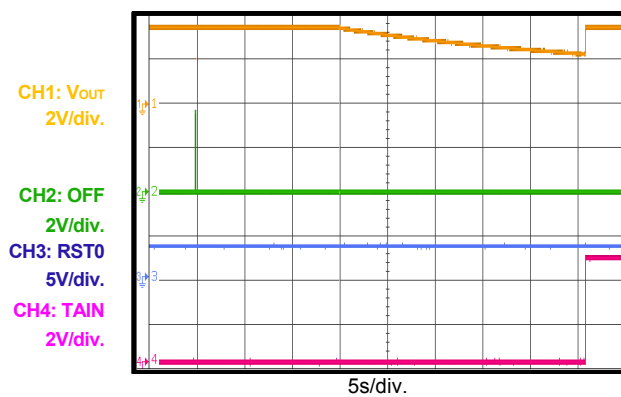

Shipping Exit with RST0

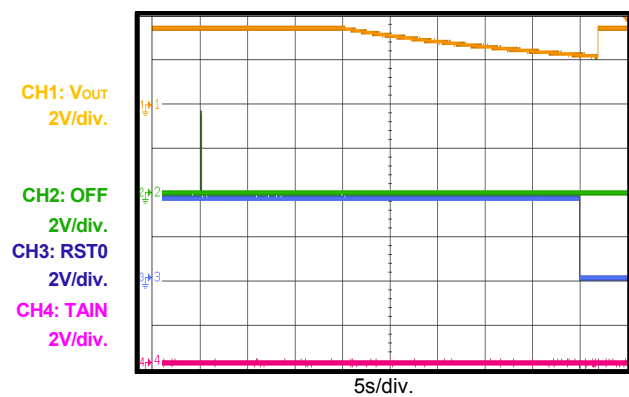

TYPICAL PERFORMANCE CHARACTERISTICS *(continued)*

$V_{IN} = 3.6V$, $T_A = 25^{\circ}C$, unless otherwise noted.

Start-Up

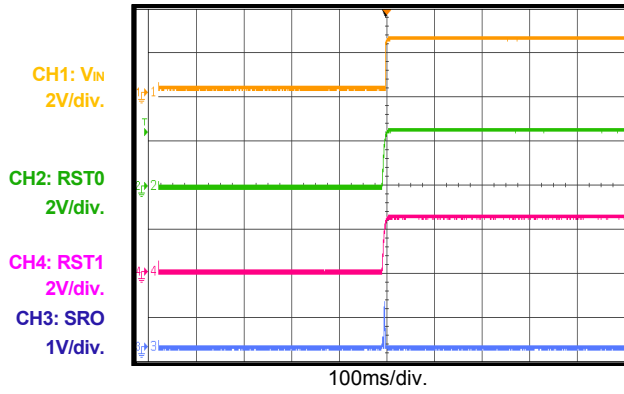

Shutdown

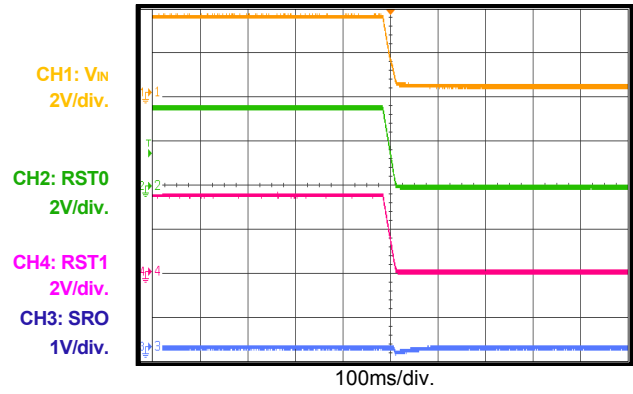

PRINTED CIRCUIT BOARD LAYOUT

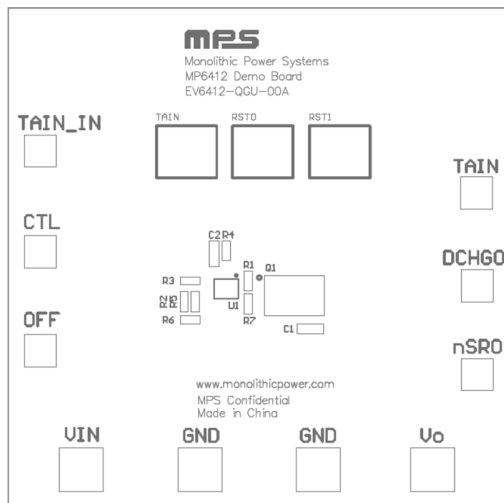

Figure 1—Top Silk Layer

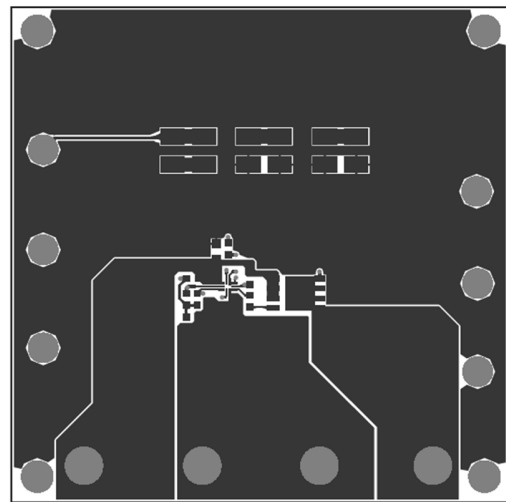

Figure 2—Top Layer

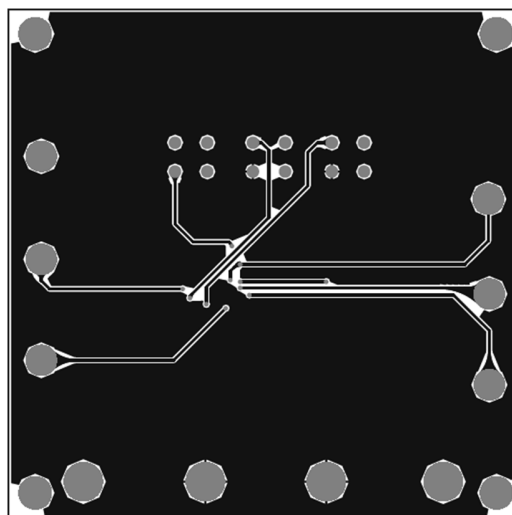

Figure 3—Middle Layer

QUICK START GUIDE

1. Connect the positive and negative terminals of the load to the V_O and GND pins, respectively.
2. Preset the power supply output between 2.2 V and 12V, and then turn off the power supply.
3. Connect the positive and negative terminals of the power supply output to the V_{IN} , and GND pin.
4. Turn the power supplies on, MP6412 will startup automatically.

NOTICE: The information in this document is subject to change without notice. Users should warrant and guarantee that third party Intellectual Property rights are not infringed upon when integrating MPS products into any application. MPS will not assume any legal responsibility for any said applications.