

DESCRIPTION

The EV6302DD-00A Evaluation Board is designed to demonstrate the capabilities of MP6302. The MP6302 is a energy storage and release control IC. Energy is charged and stored in the storage capacitors during power up, and released when input power is lost. The input voltage can be regulated at customer designed voltage for as long as possible.

The MP2205A is working with the MP6302 to construct a complete solution for demonstration.

The MP6302 requires a minimum number of readily available standard external components and is available in a space saving 2mmx3mm QFN 10 package.

ELECTRICAL SPECIFICATION

Parameter	Symbol	Value	Units
Input Voltage	V_{IN}	5	V
Storage Voltage	V_{STRG}	8.5	V
Released Voltage	V_{RLS}	4.2	V
Output Voltage for DCDC Converter	V_{OUT}	1.8	V
Max Output Current for DCDC Converter	I_{OUT}	2.5	A

FEATURES

- Wide 4.5V to 18V Input Operating Range
- 2.5A dumping current from Storage to VIN
- Built-in Current Limit for Charging Storage Capacitor
- Auto Refresh for Maintaining Storage Voltage
- Power Good Indicators for Input and Storage Voltage
- Available in a 2mmx3mm QFN10 Package

APPLICATIONS

- Hard Dish Drives
- Solid State Drives

For MPS green status, please visit MPS website under Quality Assurance. "MPS" and "The Future of Analog IC Technology", are Registered Trademarks of Monolithic Power Systems, Inc.

ADAM (Analog Digital Adaptive Modulation), AAM (...) are Trademarks of Monolithic Power Systems, Inc.

EV6302DD-00A EVALUATION BOARD



(L x W) 6.35cm x 6.35cm

Board Number	MPS IC Number
EV6302DD-00A	MP6302DD

V_{STORAGE} Release

$V_{strg}=8.5V$, $V_{rls}=4.2V$, $P_{rls}=0.3W$

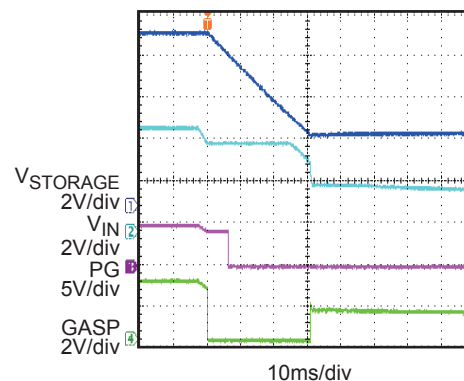

EVALUATION BOARD SCHEMATIC

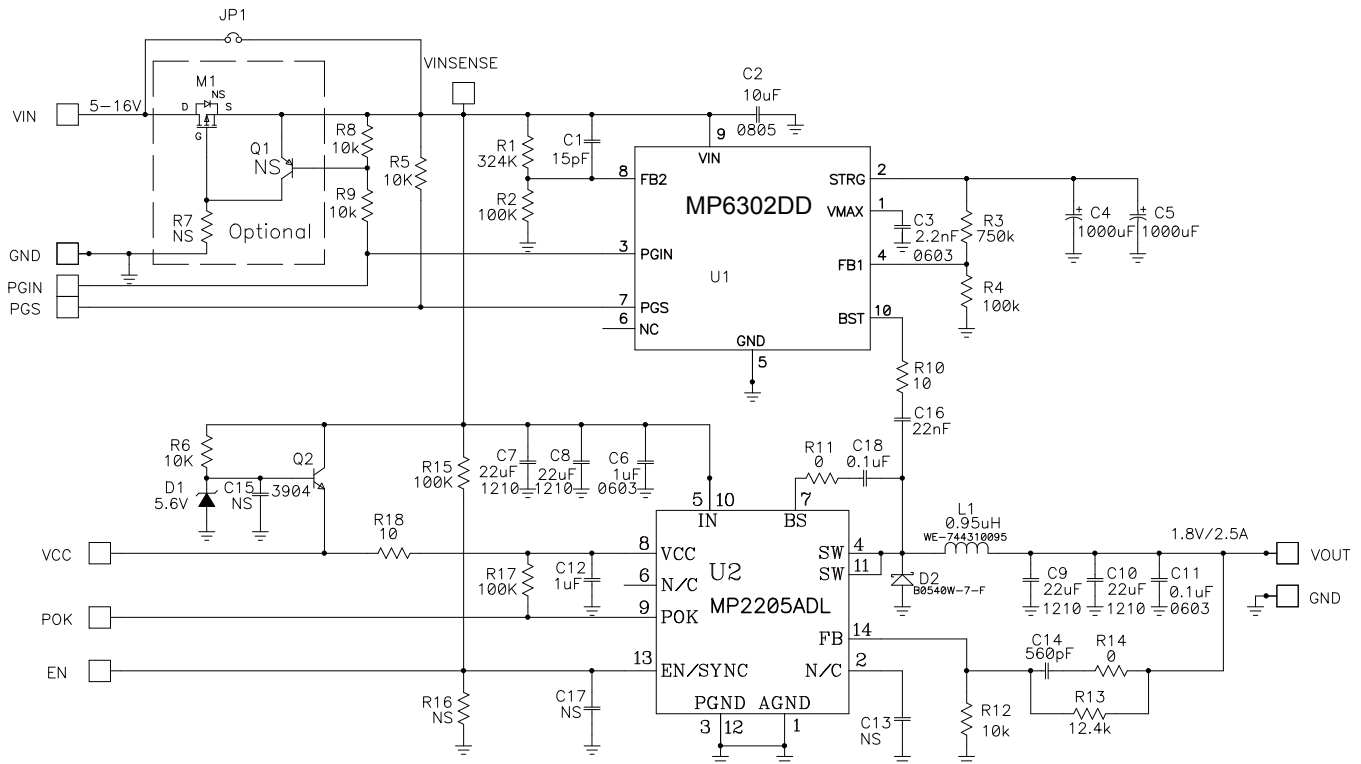

EV6302DD-00A BILL OF MATERIALS

Qty	Ref	Value	Description	Package	Manufacturer	Part Number
1	C1	15pF	Ceramic Cap., 50V, 5%, COG	0603	muRata	GRM1885C1H150JA01D
1	C2	10 μ F	Ceramic Cap., 16V, 20%, X5R	0805	muRata	GRM21BR61C106KE15L
1	C3	2.2nF	Ceramic Cap. 50V X7R 10%	0603	muRata	GRM188R71H222KA01D
2	C4, C5	1000 μ F	Al. Cap.25V, 20%	10x20x5mm	Any or Panasonic	Any or ECA-1EM102B
2	C6, C12	1 μ F	Ceramic Cap., 16V, 10%, X7R	0603	muRata	GRM188R71C105KA12D
2	C7, C8	22 μ F	Ceramic Cap, 16V, 10%, X7R	1210	muRata	GRM32ER71C226KE18L
2	C9, C10	22 μ F	Ceramic Cap, 10V, 10%, X7R	1210	muRata	GRM32ER71A226KE20L
2	C11, C18	0.1 μ F	Ceramic Cap, 25V, 10%, X7R	0603	muRata	GRM188R71E104KA
	C13, C15, C17	NS				

EV6302DD-00A BILL OF MATERIALS (Continued)

Qty	Ref	Value	Description	Package	Manufacturer	Part Number
1	C14	560pF	Ceramic Cap., 50V, 5%, COG	0603	muRata	GRM1885C1H561JA01D
1	C16	22nF	Ceramic Cap., 16V, 10%, X7R	0603	muRata	GRM188R71C223KA01D
1	R1	324k	Thick Film, 1/10W, 1%	0603	Yageo	RC0603FR-07324KL
4	R2, R4, R15, R17	100k	Thick Film, 1/10W, 1%	0603	Yageo	RC0603FR-07100KL
1	R3	750k	Thick Film, 1/10W, 1%	0603	Yageo	RC0603FR-07750KL
5	R5, R6, R8, R9, R12	10k	Thick Film, 1/10W, 1%	0603	Yageo	RC0603FR-0710KL
	R7, R16	NS				
2	R10, R18	10	Thick Film, 1/10W, 5%	0603	Yageo	RC0603JR-0710RL
2	R11, R14	0	Thick Film, 1/10W, 5%	0603	Yageo	RC0603JR-070RL
1	R13	12.4k	Thick Film, 1/10W, 1%	0603	Yageo	RC0603FR-0712K4L
1	D1	5.6V	Ziner Diode	SOD-323	Diodes Inc.	BZT52C5V6S-7-F
1	D2	500mA	DIODE SCHOTTKY 40V	SDO-123	Diodes Inc.	B0540W-7-F
1	JP1		2 pins plug	0.1"x2	Sullins	PCC02AAN
1	Jumper1	JP1	2 PIN 2.54 mm Short Jumper	0.1"	Sullins	STC02SYAN
1	L1	0.95µH	Inductor, 6.4mΩ, 13A	7x7x3mm	Würth Elec.	we-744310095
	M1	NS				
	Q1	NS				
1	Q2	3904	TRANSISTOR NPN 40V/200mA	SOT-23	Micro Commercial	MMBT3904-TP
1	U1	MP6302	Gasp controller	QFN10 (2X3mm)	MPS	MP6302 ED (R0)
1	U2	MP2205A	Step-Down Converter	QFN14 (3X4mm)	MPS	MP2205ADL (R26)

EVB TEST RESULTS

Performance waveforms are tested on the evaluation board.

$V_{IN} = 5V$, $V_{STORAGE} = 8.5V$, $V_{RELEASE} = 4.2V$, For DCDC Converter: $P_{OUT} = 0.3W$, $V_{OUT} = 1.8V$, $L = 0.95\mu H$, $T_A = +25^\circ C$, unless otherwise noted.

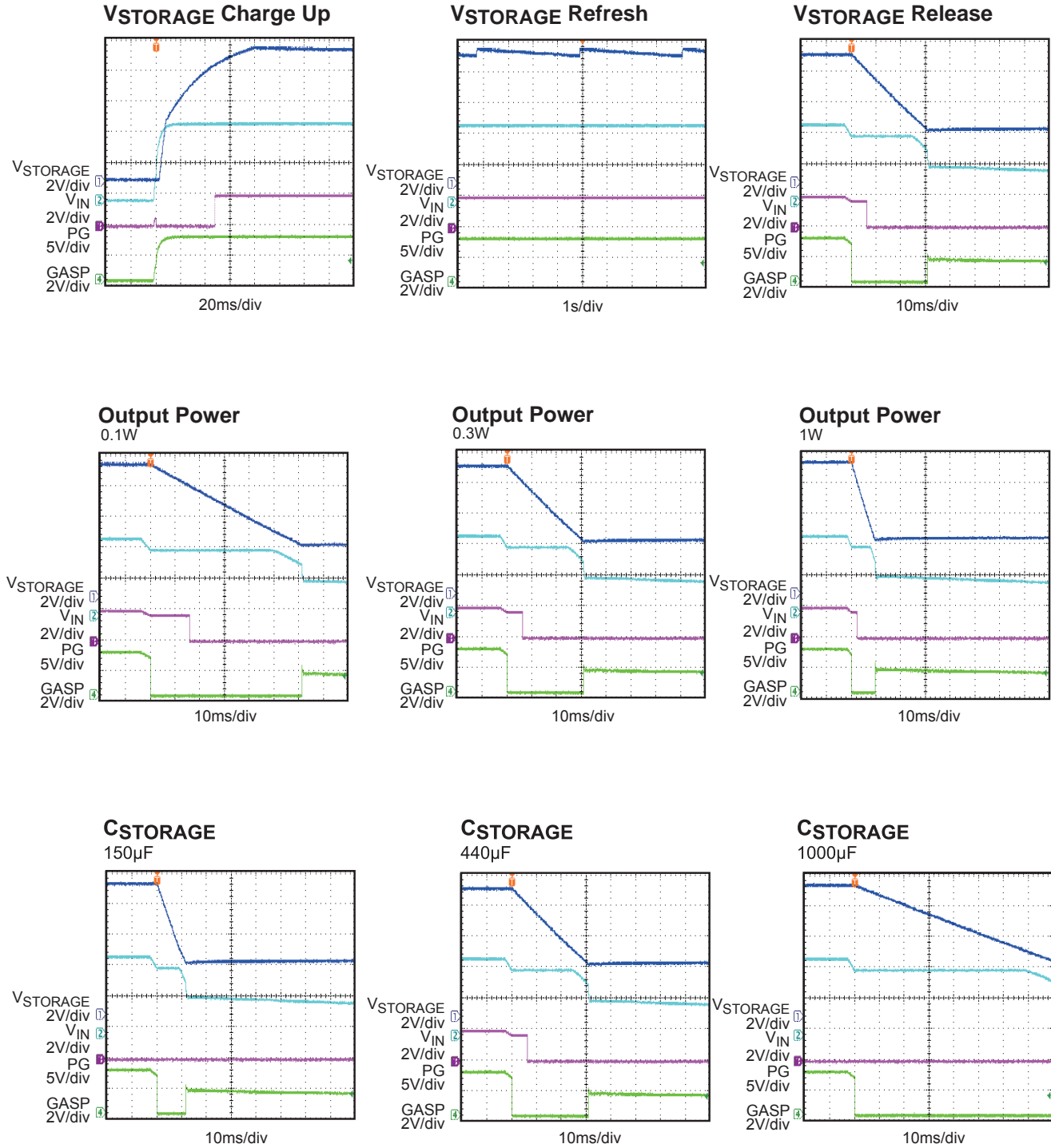

PRINTED CIRCUIT BOARD LAYOUT

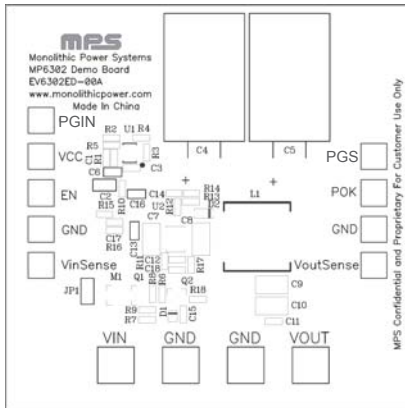

Figure 1—Top Silk Layer

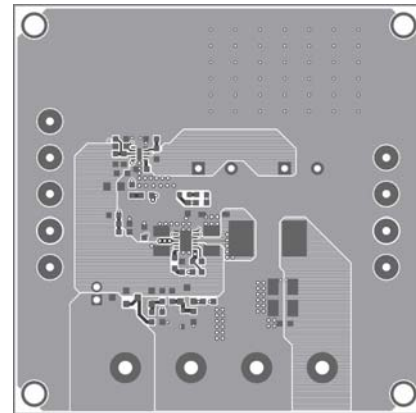

Figure 2—Top Layer

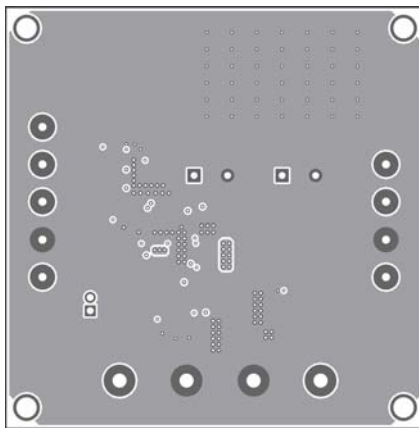

Figure 3—Inner 1 Layer

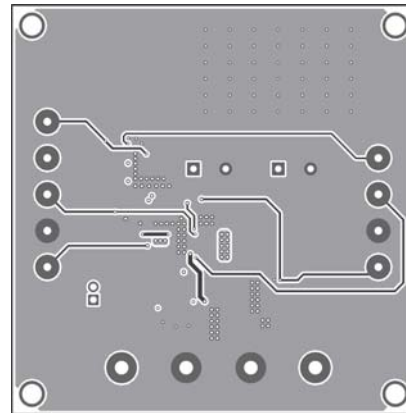

Figure 4—Inner 2 Layer

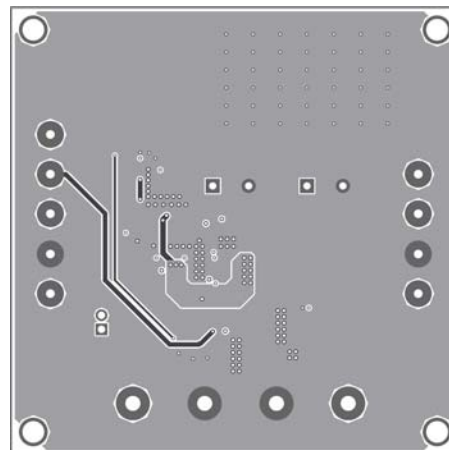

Figure 5—Bottom Layer

QUICK START GUIDE

The board layout accommodates most commonly used components.

1. Connect the positive and negative terminals of the load to VOUT and GND pins, respectively.
2. Preset Power Supply to $4.2V \leq V_{IN} \leq 8V$.
3. Turn Power Supply off.
4. Connect Power Supply terminals to:
 - a. Positive (+): VIN
 - b. Negative (-): GND
5. Turn Power Supply on after making connections, MP6302 will charge the storage capacitor to around 8.5V after DCDC converter completes start-up.
6. In order to observe the power release performance, following two methods can be applied:
 - a. For long release time (more than several tens ms, such as this EVB setup), directly turning off the power supply is good enough for observe clear release period.
 - b. If shorter release time is required, the optional input disconnect circuit on the board is recommended. It uses the GASP signal to disconnect the input power when power is released. Directly turning off the power supply or short the input power (Don't forget to limit the current) is available to get a good release period.
7. Use R1 and R2 to set different release voltage, please refer to the Application Section in device datasheet for proper selection. Similarly, R3 and R4 can be chosen for storage voltage setting.

NOTICE: The information in this document is subject to change without notice. Please contact MPS for current specifications. Users should warrant and guarantee that third party Intellectual Property rights are not infringed upon when integrating MPS products into any application. MPS will not assume any legal responsibility for any said applications.