

### DESCRIPTION

EV6004-Q-00A Evaluation Board is designed to demonstrate the capability of MP6004's primary-side regulate fly-back function. The MP6004 is a monolithic DC-DC converter which includes 180V power switch and targets isolated or non-isolated 13W PoE application.

MP6004 uses fixed peak current and variable frequency discontinuous conduction mode (DCM) to regulate constant output voltage. Primary-side-regulate without opto-coupler feedback in flyback mode simplify the design and save BOM cost. 180V integrated power MOSFET optimizes it for various wide voltage applications.

The MP6004 also features protection including over load, over voltage, open circuit and thermal shutdown.

The MP6004 is available in QFN-14 3mmX3mm package.

### ELECTRICAL SPECIFICATIONS

| Parameter             | Symbol     | Value | Units |
|-----------------------|------------|-------|-------|
| Input voltage         | $V_{IN}$   | 36-72 | V     |
| Output voltage        | $V_{OUT}$  | 12    | V     |
| Output current        | $I_{OUT}$  | 1     | A     |
| Programmed $I_{PEAK}$ | $I_{PEAK}$ | 2.05  | A     |

### FEATURES

- Primary-side Regulate Flyback without Opto-coupler Feedback
- Integrated 180V Switching Power MOSFET
- Internal 80V Startup Circuit
- Up to 3A Programmable Current Limit
- Discontinuous Conduction Work Mode
- Include OLP, OVP, Open Circuit and Thermal Protection
- Flexible Self-power or External  $V_{CC}$  Power
- Minimal External Components Count
- Available in QFN-14 3mmx3mm Package

### APPLICATIONS

- Security Camera
- VoIP Phones
- WLAN Access Points
- General Flyback Converter

All MPS parts are lead-free, halogen free, and adhere to the RoHS directive. For MPS green status, please visit MPS website under Quality Assurance.

"MPS" and "The Future of Analog IC Technology" are Registered Trademarks of Monolithic Power Systems, Inc.

### EV6004-Q-00A EVALUATION BOARD



(L x W x H) (6.35cm x 3.2cm x 1.5cm)

| Board Number | MPS IC Number |
|--------------|---------------|
| EV6004-Q-00A | MP6004GQ      |

Efficiency

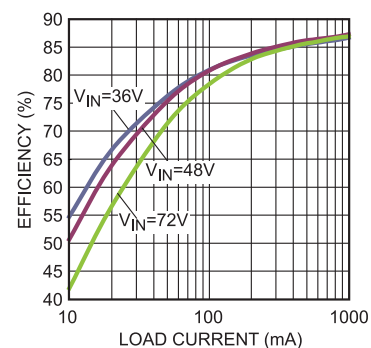

## EVALUATION BOARD SCHEMATIC

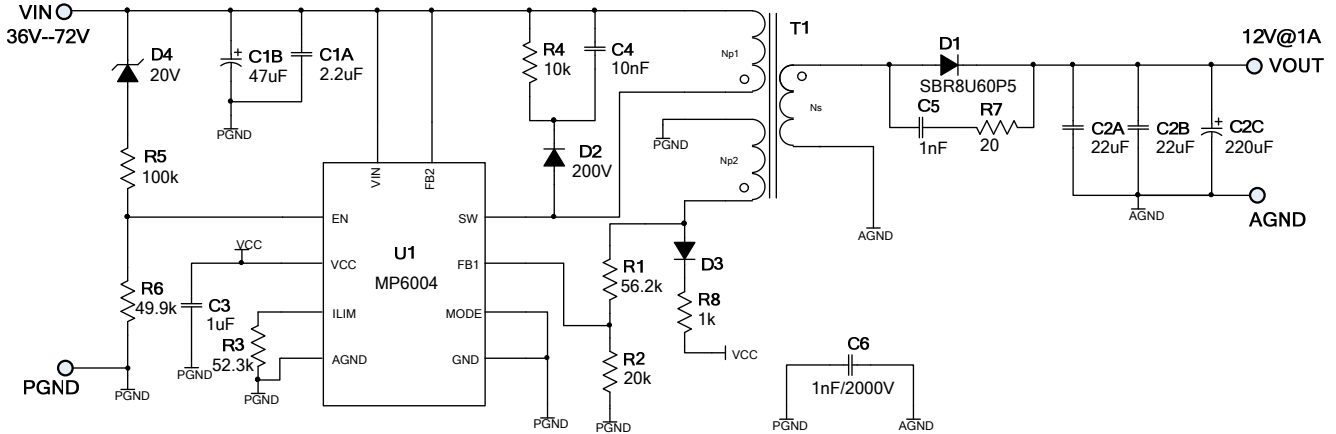

## EV6004-Q-00A BILL OF MATERIALS

| Qty | Ref     | Value     | Description                               | Package  | Manufacturer | Part Number        |
|-----|---------|-----------|---|----------|--------------|--------------------|
| 1   | C1A     | 2.2μF     | Ceramic Cap., 100V, X7R                   | 1210     | muRata       | GRM32ER72A225KA35L |
| 1   | C1B     | 47μF      | 47μF 100V CD284 E-Cap<br>10X12.5mm        | DIP      | JiangHai     | 47uF/100V          |
| 2   | C2A,C2B | 22μF      | Ceramic Cap.,25V,X7R                      | 1210     | muRata       | GRM32ER71E226KE15L |
| 1   | C2C     | 220μF     | 220μF 25V CD284 E-Cap<br>8X12.5mm         | DIP      | JiangHai     | 22uF/25V           |
| 1   | C3      | 1μF       | Ceramic Cap,10V,X7R                       | 0603     | muRata       | GRM188R71A105KA61D |
| 1   | C4      | 10nF      | Ceramic Cap,100V,X7R                      | 0805     | muRata       | GRM216R72A103KA01D |
| 1   | C5      | 1nF       | Ceramic Cap,100V,X7R                      | 0603     | muRata       | GRM188R72A102KA01D |
| 1   | C6      | 1nF       | Ceramic Cap. 2000V X7R                    | 1808     | muRata       | GR442QR73D102KW01L |
| 1   | R1      | 56.2k     | Film Res,1%                               | 0603     | ROYAL        | RC0603FR-0756K2L   |
| 1   | R2      | 20k       | Film Res,1%                               | 0603     | ROYAL        | RC0603FR-0720KL    |
| 1   | R3      | 52.3k     | Film Res,1%                               | 0603     | ROYAL        | RC0603FR-0752K3L   |
| 1   | R4      | 10k       | Film Res,5%                               | 1206     | ROYAL        | RC1206JR-0710KL    |
| 1   | R5      | 100k      | Film Res,1%                               | 0603     | ROYAL        | RC0603FR-07100KL   |
| 1   | R6      | 49.9k     | Film Res,1%                               | 0603     | ROYAL        | RC0603FR-0749K9L   |
| 1   | R7      | 20Ω       | Film Res,5%                               | 0805     | ROYAL        | RC0805JR-0720RL    |
| 1   | R8      | 1k        | Film Res,1%                               | 0603     | ROYAL        | RC0603FR-071KL     |
| 1   | D1      | SBR8U60P5 | 8A 60V SUPER BARRIER<br>RECTIFIER         | POWERDI5 | Diodes       | SBR8U60P5          |
| 1   | D2      | BAV21     | Switching Diode 200V<br>200mW             | SOD-123  | Diodes       | BAV21W-7-F         |
| 1   | D3      | 1N4148    | Switching Diode 75V 250mW                 | SOD-323  | Diodes       | 1N4148WS-7         |
| 1   | D4      | BZT52C20  | 20V zener                                 | SOD-123  | Diodes       | WBZT52C20          |
| 1   | T1      | 47.4μH    | Np:Ns:Na=22:10:6,<br>Lp=47.4μH, Core=EE13 | EE13     | EMEI         | POE12W12V          |

### EVB TEST RESULTS

$V_{IN}=48V$ ,  $V_{OUT}=12V$ ,  $I_{OUT}=1A$ ,  $T_A=25^{\circ}C$ , unless otherwise noted.

Efficiency

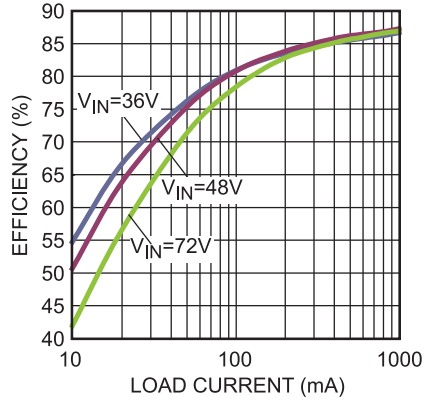

Load Regulation

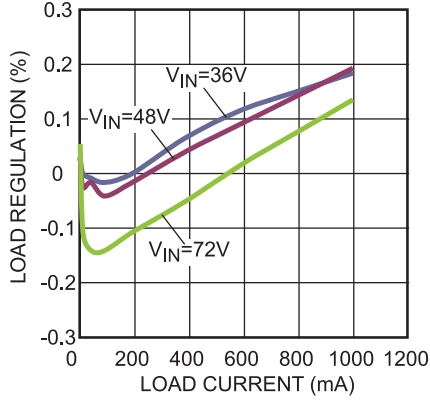

Line Regulation

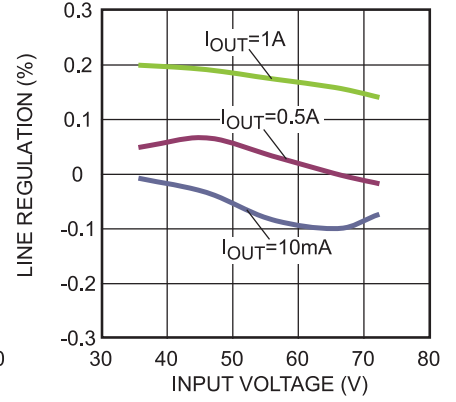

Case Temperature Rise

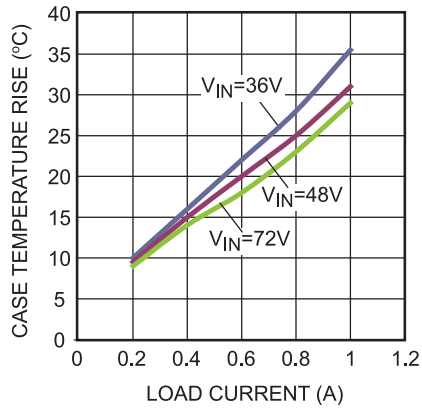

**EVB TEST RESULTS (continued)**

$V_{IN}=48V$ ,  $V_{OUT}=12V$ ,  $I_{OUT}=1A$ ,  $T_A=25^{\circ}C$ , unless otherwise noted.

**Steady State**

$I_{OUT} = 10mA$

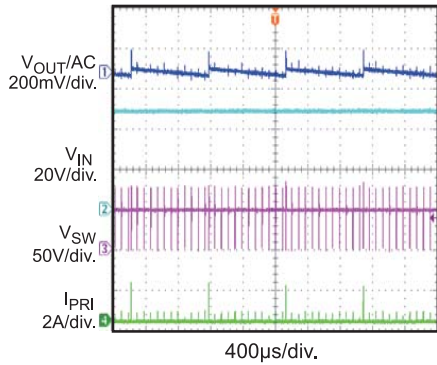

**Steady State**

$I_{OUT} = 100mA$

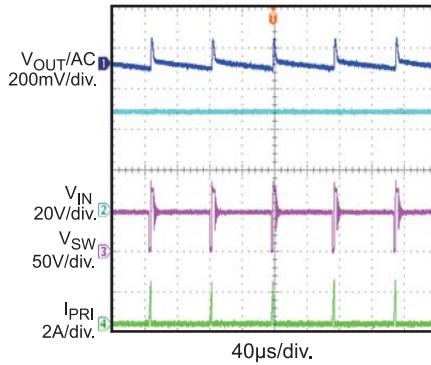

**Steady State**

$I_{OUT} = 1A$

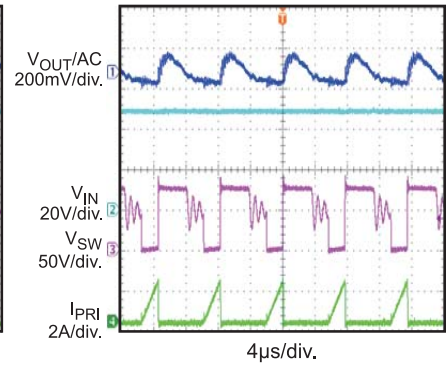

**VIN Start-Up**

$I_{OUT} = 10mA$

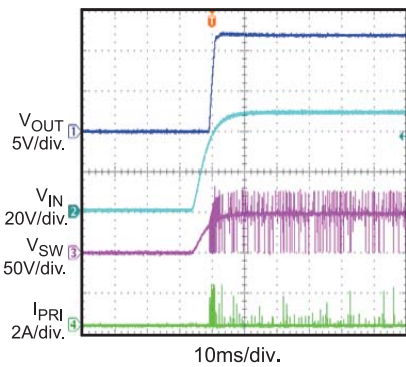

**VIN Start-Up**

$I_{OUT} = 1A$

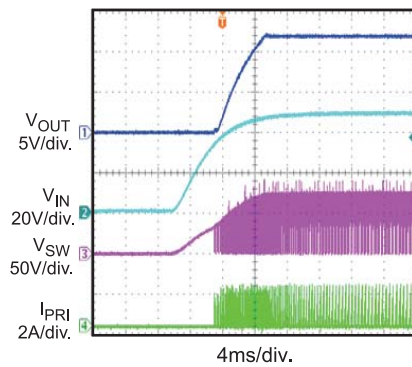

**VIN Shutdown**

$I_{OUT} = 10mA$

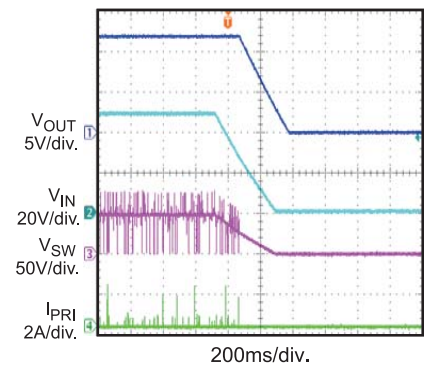

**VIN Shutdown**

$I_{OUT} = 1A$

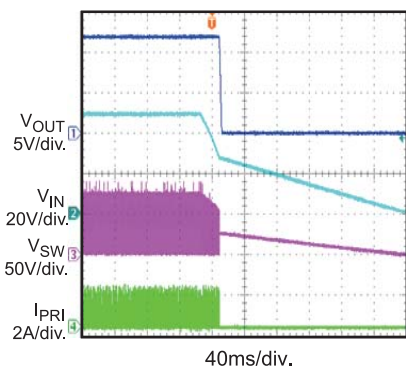

**EN Start-Up**

$I_{OUT} = 10mA$

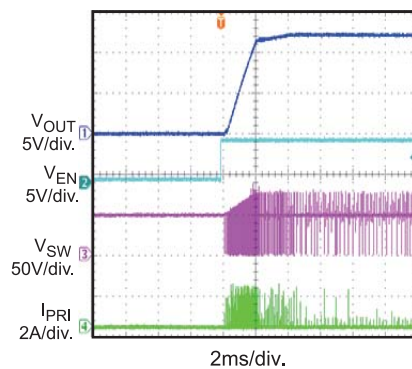

**EN Start-Up**

$I_{OUT} = 1A$

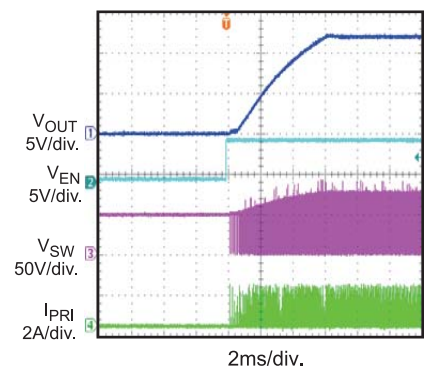



**EVB TEST RESULTS (continued)**

$V_{IN}=48V$ ,  $V_{OUT}=12V$ ,  $I_{OUT}=1A$ ,  $T_A=25^{\circ}C$ , unless otherwise noted.

**EN Shutdown**

$I_{OUT} = 10mA$

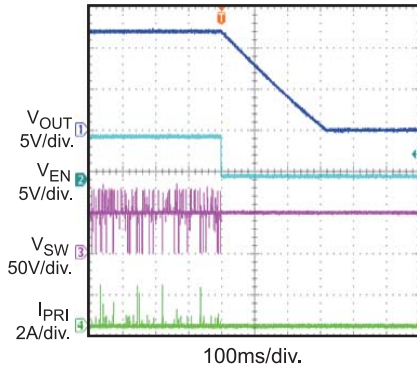

**EN Shutdown**

$I_{OUT} = 1A$

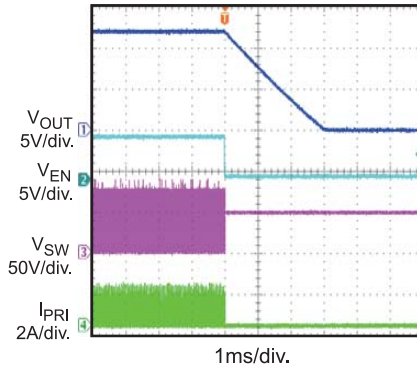

**SCP Entry**

$I_{OUT} = 10mA$

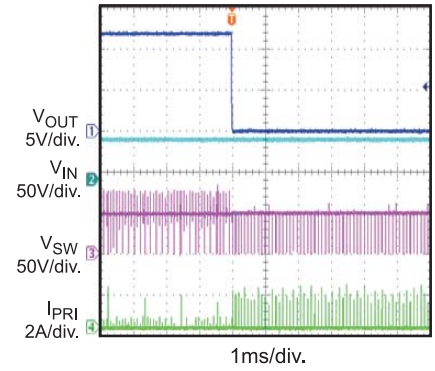

**SCP Entry**

$I_{OUT} = 1A$

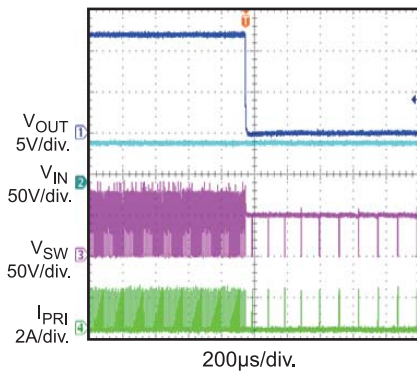

**SCP Recovery**

$I_{OUT} = 10mA$

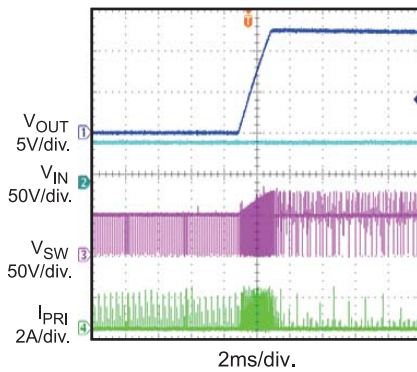

**SCP Recovery**

$I_{OUT} = 1A$

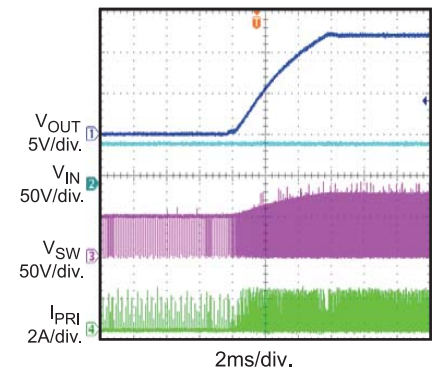

**Load Transient**

$I_{OUT} = 10mA$  to  $0.5A$ ,  
 $I_{RAMP} = 25mA/\mu s$

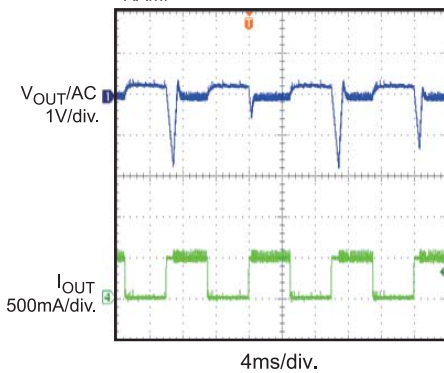

**Load Transient**

$I_{OUT} = 0.5A$  to  $1A$ ,  
 $I_{RAMP} = 25mA/\mu s$

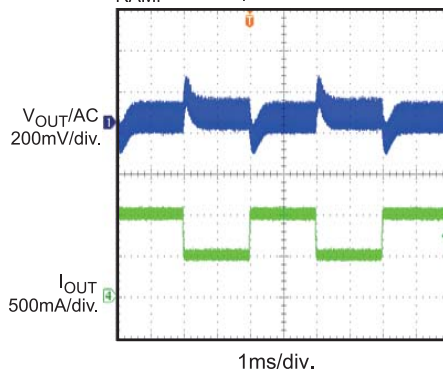

**OVP**

$I_{OUT} = 100mA$  to  $2mA$

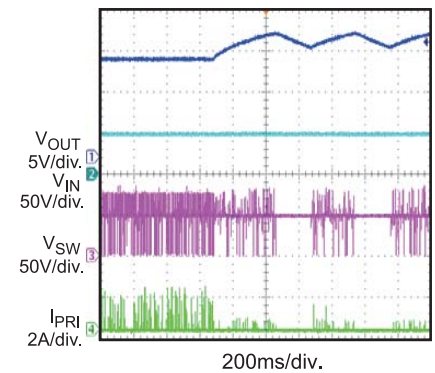

**EVB TEST RESULTS (continued)**

$V_{IN}=48V$ ,  $V_{OUT}=12V$ ,  $I_{OUT}=1A$ ,  $T_A=25^{\circ}C$ , unless otherwise noted.

**FB1 Open Circuit Entry**  
 $I_{OUT} = 1A$

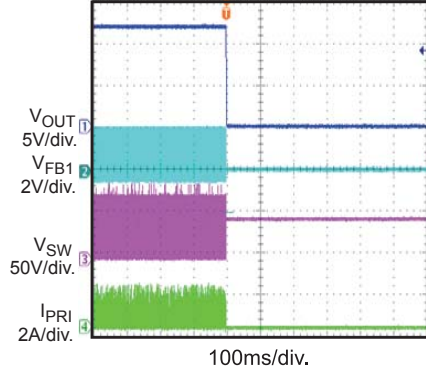

**FB1 Open Circuit Recovery**  
 $I_{OUT} = 1A$

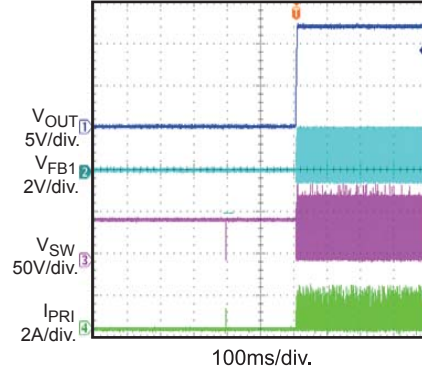

**PRINTED CIRCUIT BOARD LAYOUT**

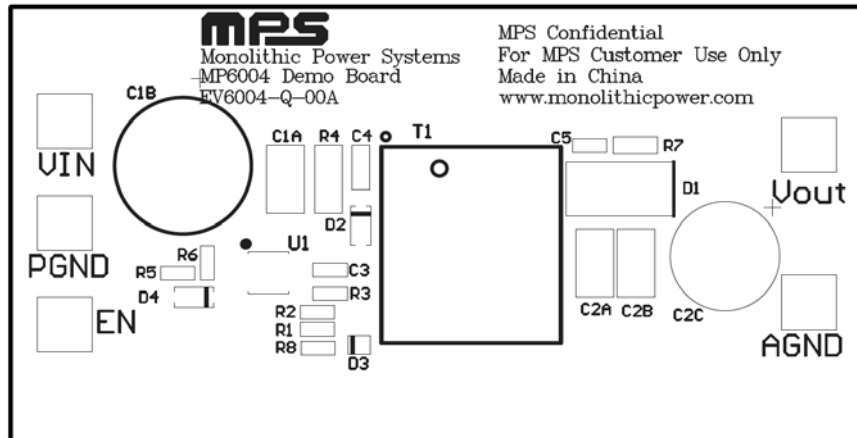

**Figure 1: Top Silk Layer**

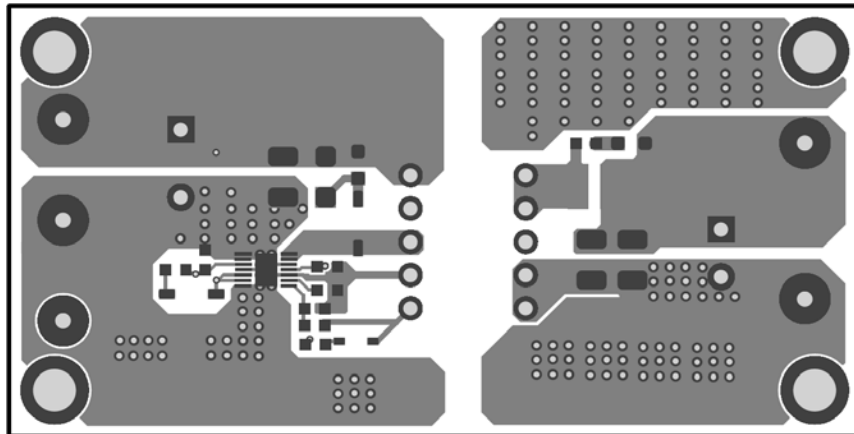

**Figure 2: Top Layer**

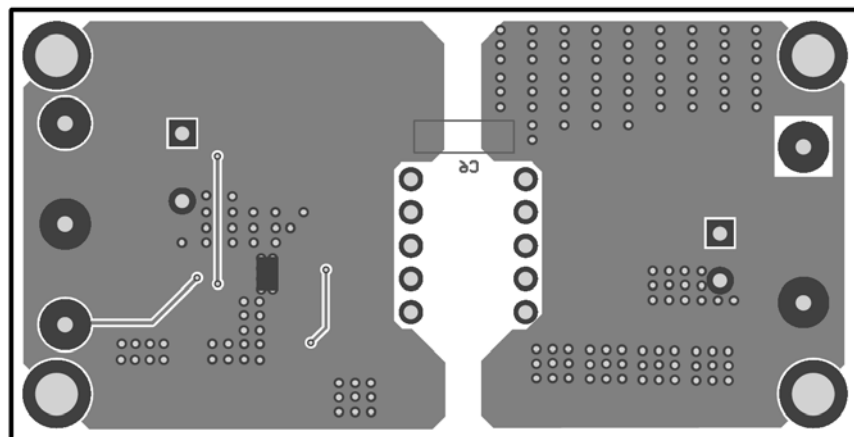

**Figure 3: Bottom Layer**

## QUICK START GUIDE

The output voltage of this board is set to 12V. The board layout accommodates most commonly used components.

1. Preset Power Supply to  $36V \leq V_{IN} \leq 72V$ .
2. Turn Power Supply off.
3. Connect Power Supply terminals to:
  - a. Positive (+): VIN
  - b. Negative (-): PGND
4. Connect Load to:
  - a. Positive (+): VOUT
  - b. Negative (-): AGND
5. Turn Power Supply on after making connections.
6. The MP6004 is enabled on the evaluation board once VIN is applied.
7. To use the Enable function, apply a digital input to the EN pin. Drive EN higher than 3.9V to turn on EV6004-Q-00A or less than 1.3V to turn it off.
8. MP6004 can supply  $V_{CC}$  through internal high voltage LDO, D3 and R8 can be removed to save BOM cost, while it may lead to 0.2% efficiency decreasing.
9. If testing EV6004-Q-00A in no load condition, please add about 10mA dummy load for good regulation and avoiding MP6004 enter OVP protection.

**NOTICE:** The information in this document is subject to change without notice. Users should warrant and guarantee that third party Intellectual Property rights are not infringed upon when integrating MPS products into any application. MPS will not assume any legal responsibility for any said applications.