



The Future of Analog IC Technology®

# EV6001DN-00D

WLED Driver  
Evaluation Board

## GENERAL DESCRIPTION

The EV6001DN-00D is an evaluation board for the WLED driver application. It can drive 6 20mA strings of WLEDs with up to 10 WLEDs per string. EV6001DN-00D has good current balance among 6 strings. It also has PWM dimming, EN function, and open circuit voltage protection.

This device is available in an 8-pin SOIC package with an exposed pad.

## ELECTRICAL SPECIFICATIONS

| Parameter      | Symbol    | Value    | Units |
|----------------|-----------|----------|-------|
| Input Voltage  | $V_{IN}$  | 7 – 21   | V     |
| Output Voltage | $V_{OUT}$ | 33       | V     |
| Output Current | $I_{OUT}$ | 20mA x 6 | mA    |

## FEATURES

- Integrated 150V Power Switch
- Integrated 100V Startup Circuit
- Cycle-by-Cycle Current Limiting
- PWM Dimming
- Open Circuit Protection
- Backlight Current Balance

## APPLICATIONS

- LCD Panel Backlight
- General and Accent Lighting

"MPS" and "The Future of Analog IC Technology" are Registered Trademarks of Monolithic Power Systems, Inc.

## EV6001DN-00D EVALUATION AND LED BOARDS



(L x W x H) 2.6" x 0.6" x 0.2"  
(6.5cm x 1.5cm x 0.5cm)

| Board Number | MPS IC Number |
|--------------|---------------|
| EV6001DN-00D | MP6001DN      |



(L x W x H) 3.3" x 0.8" x 0.2"  
(8.5cm x 2.0cm x 0.5cm)

| Board Number          | MPS IC Number |
|-----------------------|---------------|
| MP6001 LED Board -00C | MP6001DN      |

Efficiency vs  
Input Voltage

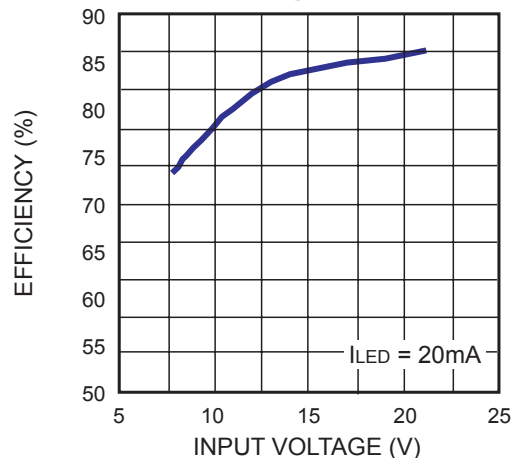

### EVALUATION BOARD SCHEMATIC

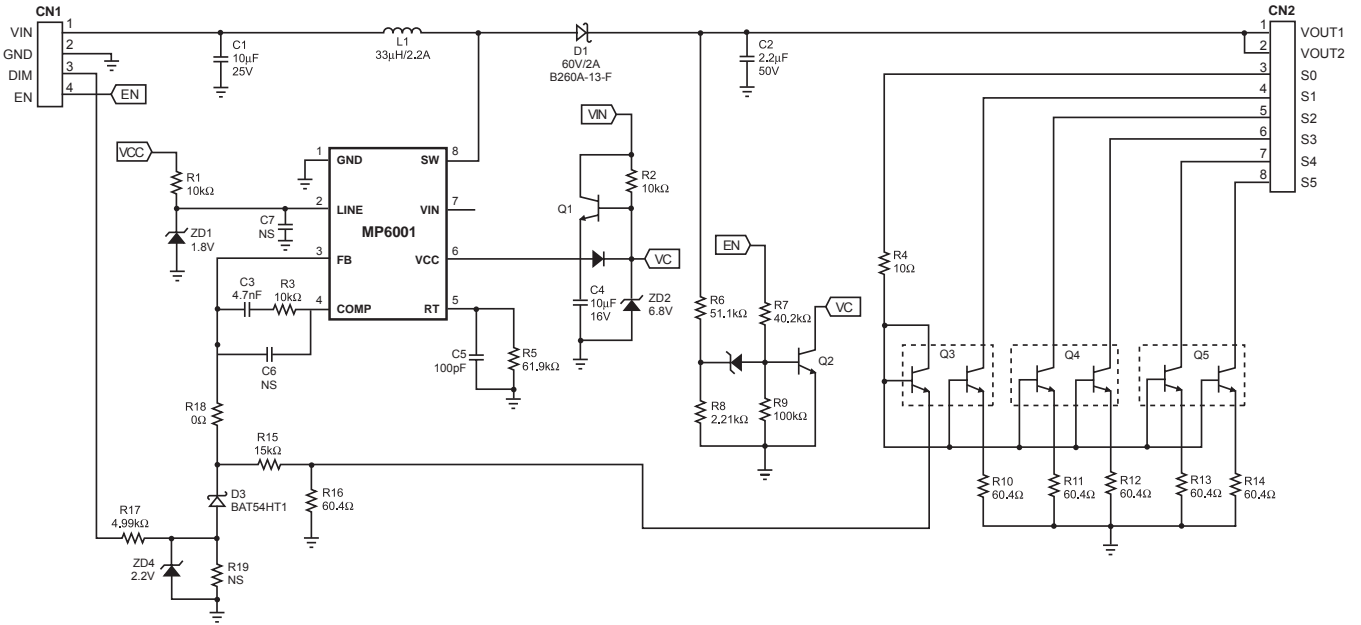

### LED BOARD SCHEMATIC

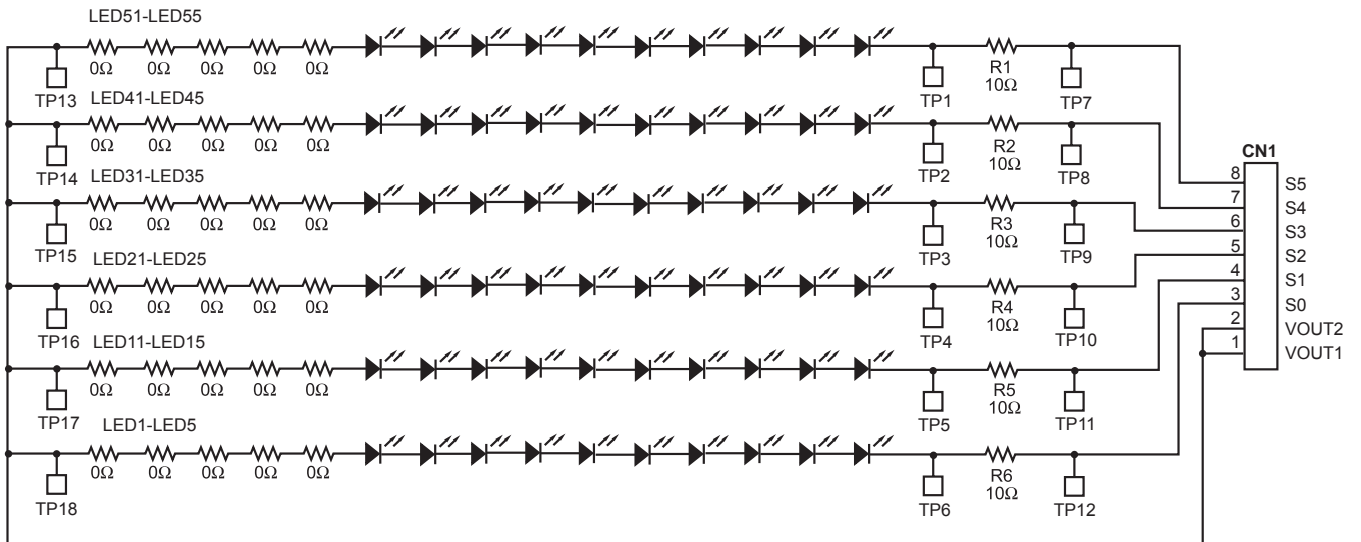

**EV6001DN-00D BILL OF MATERIALS**

| Qty | Ref                                | Value          | Description                      | Package | Manufacturer          | Part Number    |
|-----|------------------------------------|----------------|----------------------------------|---------|-----------------------|----------------|
| 1   | C1                                 | 10 $\mu$ F     | Ceramic Cap., 25V, X7R           | 1210    | TDK                   | C3225X7R1E106M |
| 1   | C2                                 | 2.2 $\mu$ F    | Ceramic Cap., 50V, X7R           | 1210    | TDK                   | C3225X7R1H225K |
| 1   | C3                                 | 4.7nF          | Ceramic Cap., 50V, X7R           | 603     | TDK                   | C1608X7R1H472K |
| 1   | C4                                 | 10 $\mu$ F     | Ceramic Cap., 16V X7R            | 1206    | TDK                   | C3216X7R1C106M |
| 1   | C5                                 | 100pF          | Ceramic Cap., 50V, NPO           | 603     | TDK                   | C1608C0G1H101J |
| 2   | C6, C7                             |                | Not Stuffed                      | 603     |                       |                |
| 2   | R1, R3                             | 10k $\Omega$   | Film Res., 5%                    | 603     | Panasonic             | ERJ-3GEYJ103V  |
| 1   | R2                                 | 10k $\Omega$   | Film Res., 5%                    | 805     | Panasonic             | ERJ-6GEYJ103V  |
| 1   | R4                                 | 10 $\Omega$    | Film Res., 5%                    | 805     | Panasonic             | ERJ-6GEYJ100V  |
| 1   | R5                                 | 61.9k $\Omega$ | Film Res., 1%                    | 603     | Panasonic             | ERJ-3EKF6192V  |
| 1   | R6                                 | 51.1k $\Omega$ | Film Res., 1%                    | 603     | Panasonic             | ERJ-3EKF5112V  |
| 1   | R7                                 | 40.2k $\Omega$ | Film Res., 1%                    | 603     | Panasonic             | ERJ-3EKF4022V  |
| 1   | R8                                 | 2.21k $\Omega$ | Film Res., 1%                    | 603     | Panasonic             | ERJ-3EKF2211V  |
| 1   | R9                                 | 100k $\Omega$  | Film Res., 5%                    | 603     | Panasonic             | ERJ-3GEYJ104V  |
| 6   | R10, R11,<br>R12, R13,<br>R14, R16 | 60.4 $\Omega$  | Film Res., 1%                    | 603     | Panasonic             | ERJ-3EKF60R4V  |
| 1   | R15                                | 15k $\Omega$   | Film Res., 5%                    | 603     | Panasonic             | ERJ-3GEYJ153V  |
| 1   | R17                                | 4.99k $\Omega$ | Film Res., 1%                    | 603     | Panasonic             | ERJ-3EKF4991V  |
| 1   | R18                                | 0 $\Omega$     | Film Res., 5%                    | 603     | Panasonic             | ERJ-3GEY0R00V  |
| 1   | R19                                |                | Not Stuffed                      | 603     |                       |                |
| 1   | L1                                 | 33 $\mu$ H     | Inductor, 2.2A                   | SMD     | Sumida                | CDR7D43MN-330  |
| 2   | Q1, Q2                             |                | Transistor, NPN, 40V, 350mW      | SOT-23  | Diodes Inc            | MMBT3904-7-F   |
| 3   | Q3, Q4, Q5                         |                | Transistor, Dual NPN, 40V, 200mA | SOT-363 | Diodes Inc            | MMDT3904-7-F   |
| 2   | ZD1, ZD3                           |                | Diode Zener, 1.8V                | SOD-323 | Central Semiconductor | CMSZ1L8        |
| 1   | ZD2                                |                | Diode Zener, 6.8V                | SOD-123 | Diodes Inc            | BZT52C6V8-7    |
| 1   | ZD4                                |                | Diode Zener, 2.2V                | SOD-323 | Central Semiconductor | CMDZ2L2        |
| 1   | CN1                                |                | Connector Header, 4P, 2mm        |         | Any                   |                |
| 1   | CN2                                |                | Connector Header, 8P, 2mm        |         | Any                   |                |
| 1   | U1                                 |                | DC-DC Converter                  | SO-8    | MPS                   | MP6001DN       |

**LED BOARD BILL OF MATERIALS** *(continued)*

| Qty | Ref  | Value | Description                  | Package | Manufacturer | Part Number   |
|-----|--|-------|------------------------------|---------|--------------|---------------|
| 6   | R1 – R6  | 10Ω   | Film Res., 5%                | 805     | Panasonic    | ERJ-6GEYJ100V |
| 60  | LED6 – LED10<br>LED16 – LED20<br>LED26 – LED30<br>LED36 – LED40<br>LED46 – LED50<br>LED56 – LED60<br>LED61 – LED90 |       | White LED, Surface Mount     | 603     | LITE-ON Inc  | LTW-C191TS5   |
| 30  | LED1 – LED5<br>LED11 – LED15<br>LED21 – LED25<br>LED31 – LED35<br>LED41 – LED45<br>LED51 – LED55                   | 0Ω    | Film Res., 5%                | 603     | Panasonic    | ERJ-3GEY0R00V |
| 1   | CN1  |       | Connector Header, 8 Pin, 2mm |         | Any          |               |

**PRINTED CIRCUIT BOARD LAYOUT**

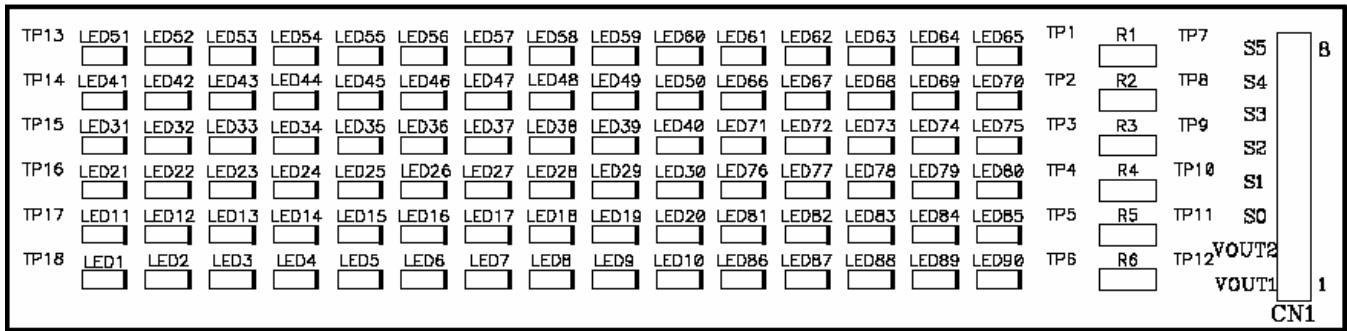

**Figure 1—LED Board Top Silk Layer**



**Figure 2—LED Board Top Layer**

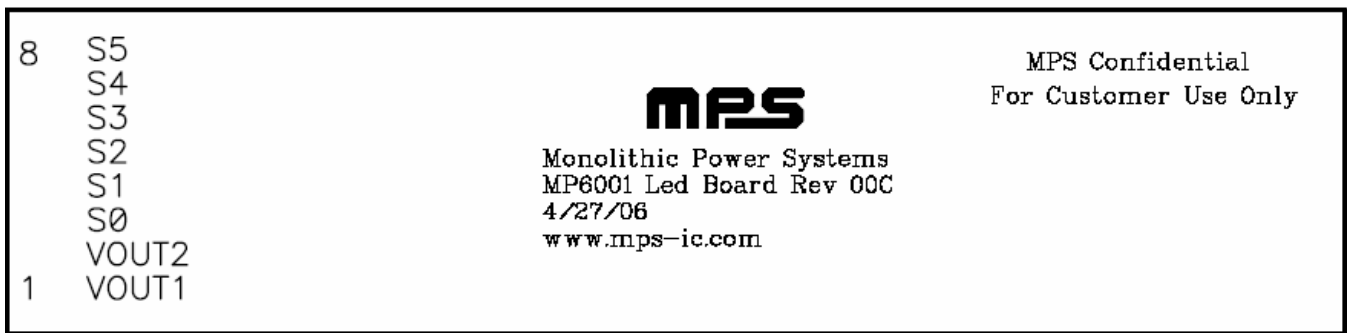

**Figure 3—LED Board Bottom Silk Layer**



**Figure 4—LED Board Bottom Layer**

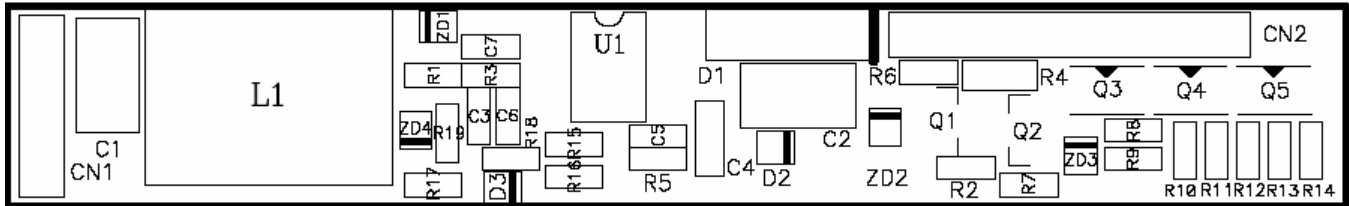

Figure 5—Evaluation Board Top Silk Layer

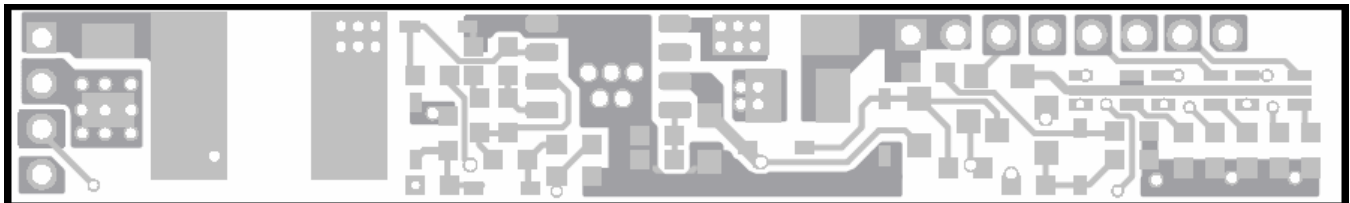

Figure 6—Evaluation Board Top Layer



Figure 7—Evaluation Board Bottom Silk Layer

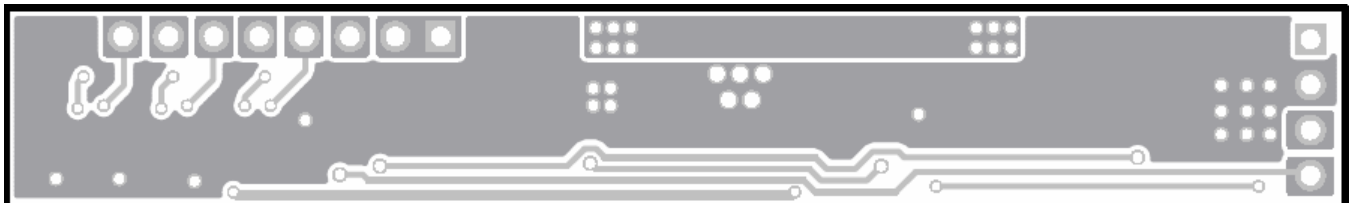

Figure 8—Evaluation Board Bottom Layer

## QUICK START GUIDE

1. Connect the LED board to the WLED driver following the pinout.
2. Preset power supply output to 7V to 21V and turn off the power supply.
3. Connect the positive terminal of the power supply output to VIN pin, and the negative terminal of the power supply output to GND pin.
4. Turn power supply on and the board will automatically startup.
5. To use Enable function, apply a digital input to EN pin. Drive EN with 2.5V-5V to turn off the regulator, and drive EN less than 0.7V to turn it on.
6. To use Dim function, apply a 1KHz PWM signal to DIM pin (High > 4V – 5V, Low < 0.5V). Change the duty cycle to adjust the brightness level.

**NOTICE:** The information in this document is subject to change without notice. Users should warrant and guarantee that third party Intellectual Property rights are not infringed upon when integrating MPS products into any application. MPS will not assume any legal responsibility for any said applications.