

DESCRIPTION

EV5507E-RG-00A Evaluation Board is designed to demonstrate the capabilities of MP5507E. The MP5507E is one front end power storage and management IC for SSD application.

MP5507E supports input hot swap, input startup inrush current control, input current limit and backup power management for SSD data backup in case of input power failure. MP5507E's built-in boost mode converter charges energy storage bulk capacitor to a programmed voltage when system is powered up and in case of input power failure, MP5507E transfers the energy from energy storage bulk capacitor to SSD system's DCDC switches via built-in buck mode converter to keep SSD system powered for data backup.

MP5507E is available in QFN16 (2.5mmX3.2mm) package.

ELECTRICAL SPECIFICATION

Parameter	Symbol	Value	Units
Input Voltage	V_{IN}	3.3	V
Charge Voltage	V_{STRG}	12	V
Bus Backup Voltage	V_{RLS}	2.9	V
Bus Backup Max Load	$I_{RELEASE}$	3	A

FEATURES

- Wide 2.7 to 7V Operating Input Range
- Internal 60mΩ Hot-swap
- Internal 100mΩ and 80mΩ Power Switches for Energy Storage and Release Management Circuits
- Up to 4.6A Input Current Limit
- Up to 3A Buck Release Current Capability
- 6V Bus Clamping Voltage
- Adjustable dv/dt Slew Rate for VB Start up
- Bus Power Good indicator
- Thermal protection
- Available in an QFN16(2.5mmx3.2mm) Package

APPLICATIONS

- Hard Disk Drives
- Solid State Drives
- Power Back-Up System

All MPS parts are lead-free, halogen free, and adhere to the RoHS directive. For MPS green status, please visit MPS website under Quality Assurance.

"MPS" and "The Future of Analog IC Technology" are Registered Trademarks of Monolithic Power Systems, Inc.

EV5507E-RG-00A EVALUATION BOARD



(L x W) 6.35cm x 6.35cm

Board Number	MPS IC Number
EV5507E-RG-00A	MP5507EGRG

VSTRG Release

$I_B=3A$
 $C_{STRG}=200\mu F$

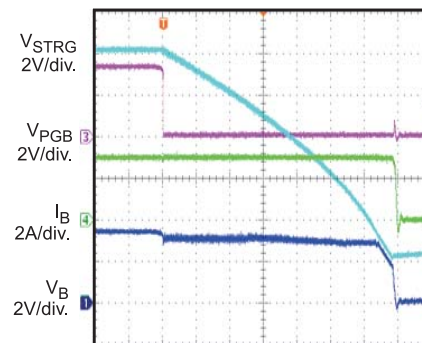

200µs/div.

EVALUATION BOARD SCHEMATIC

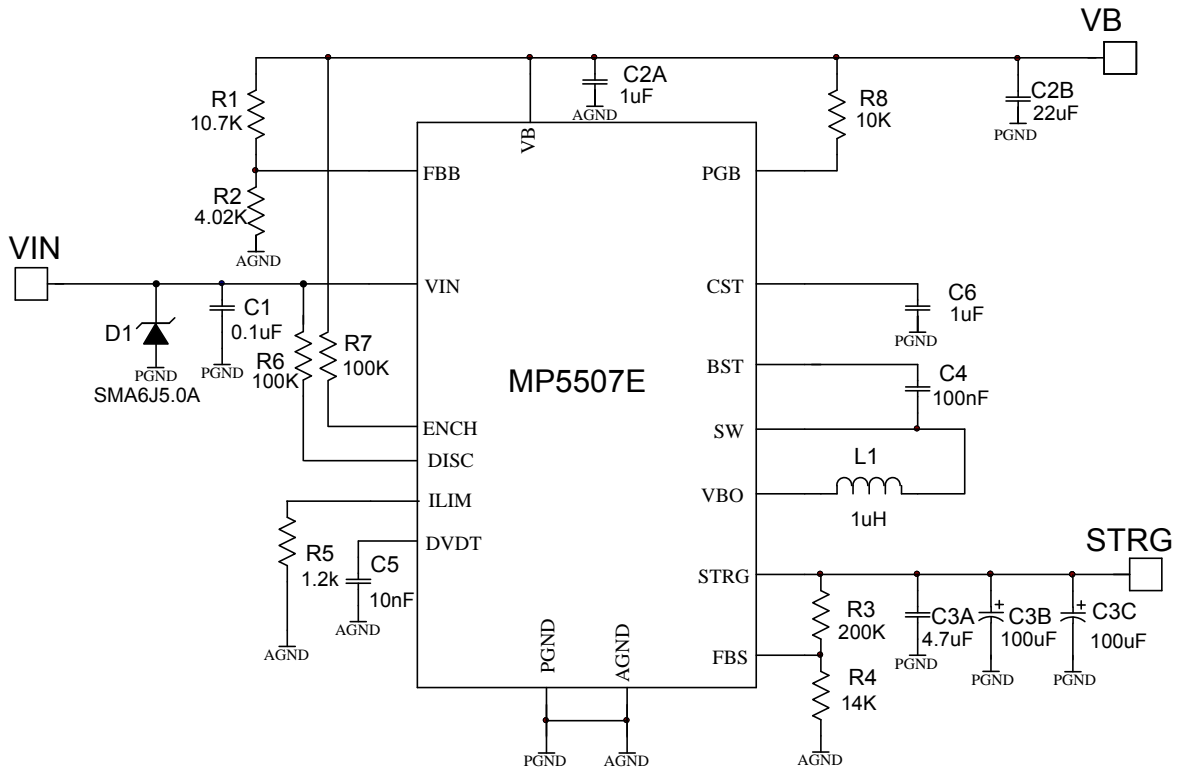

EV5507E-RG-00A BILL OF MATERIALS

Qty	Ref	Value	Description	Package	Manufacturer	Manufacturer P/N
1	L1	1 μ H	1 μ H, DCR 4.6m Ω , Isat 19A	SMD	Würth	744311110
1	R1	10.7k	Film Res., 1%	0603	Royal	RL0603FR-0710K7L
1	R2	4.02k	Film Res., 1%	0603	Royal	RL0603FR-074K02L
1	R3	200k	Film Res., 1%	0603	Yageo	RC0603FR-07200KL
1	R4	14k	Film Res., 1%	0603	Yageo	RC0603FR-0714KL
1	R5	1.2k	Film Res., 1%	0603	Yageo	RC0603FR-071K2L
2	R6, R7,	100k	Film Res., 1%	0603	Yageo	RC0603FR-07100KL
1	R8	10k	Film Res., 1%	0603	Yageo	RC0603FR-0710KL
2	C1, C4	100nF	Ceramic Cap., 25V, X7R	0603	Murata	GRM188R71E104KA01D
1	C2B	22 μ F	Ceramic Cap., 10V, X5R	1206	Murata	GRM31CR61A226ME19L
2	C2A, C6	1 μ F	Ceramic Cap, 16V, X7R	0603	Murata	GRM188R71C105KA12D
1	C3A	4.7 μ F	Ceramic Cap., 25V, X5R	1206	Murata	C3216X5R1C475K
2	C3B, C3C	100 μ F	CD284/25V/100 μ F		Jianghai	ECR1EXY101M063011
1	C5	10nF	Ceramic Cap., 16V, X7R	0603	Murata	GRM188R71C103KA01D
1	D1	SMA6J5.0A	TVS DIODE	SMA	VISHAT	SMA6J5.0A
1	U1	MP5507E	MP5507EGRG	QFN16-2.5x3.2mm	MPS	MP5507EGRG

EVB TEST RESULTS

Performance waveforms are tested on the evaluation board.

$V_{IN} = 3.3V$, $V_{STORAGE} = 12V$, $V_{RELEASE} = 2.9V$, $T_A = +25^{\circ}C$, unless otherwise noted.

Release Time Vs. Storage Capacitance

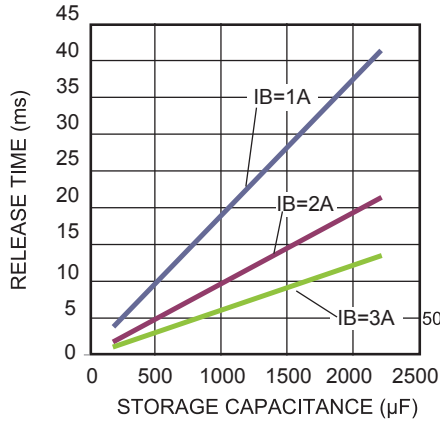

Vin Power On

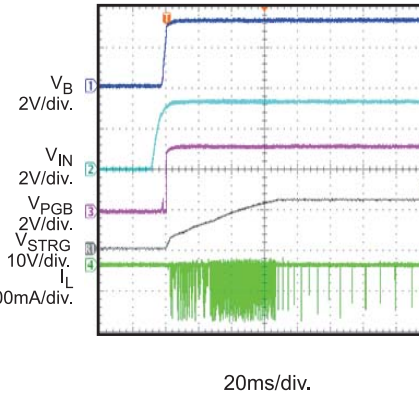

ENCH Power On

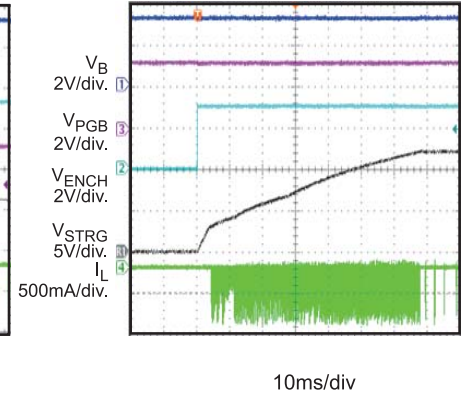

VSTRG Release

IB=0.5A, CSTRG=200µF

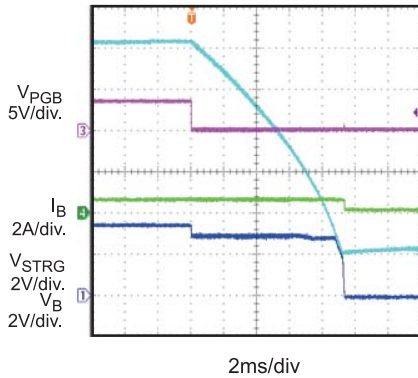

VSTRG Release

IB=1A, CSTRG=200µF

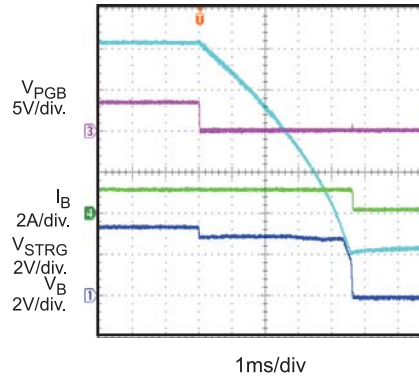

VSTRG Release

IB=2A, CSTRG=200µF

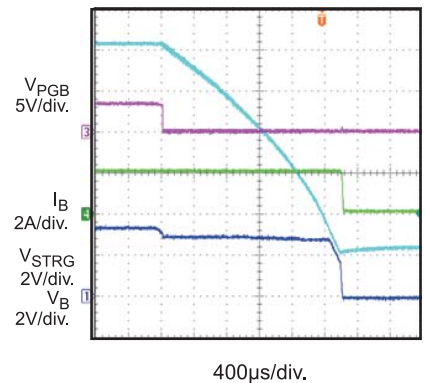

VSTRG Release

IB=3A, CSTRG=2200µF

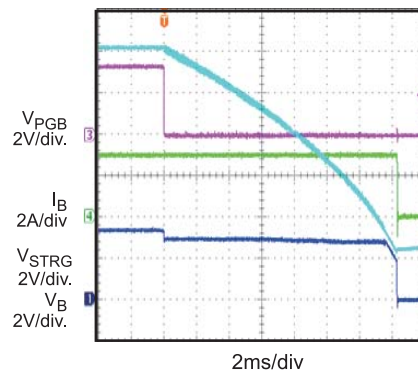

VSTRG Release

IB=3A, CSTRG=1000µF

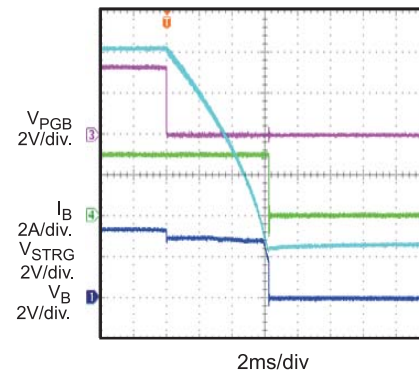

VSTRG Release

IB=3A, CSTRG=470µF

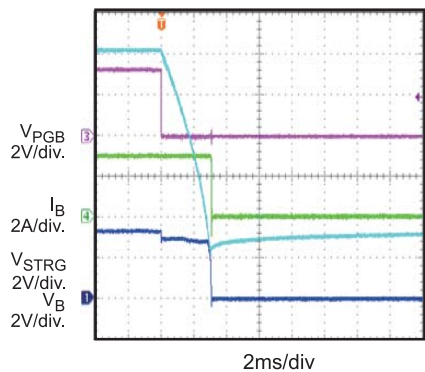

PRINTED CIRCUIT BOARD LAYOUT

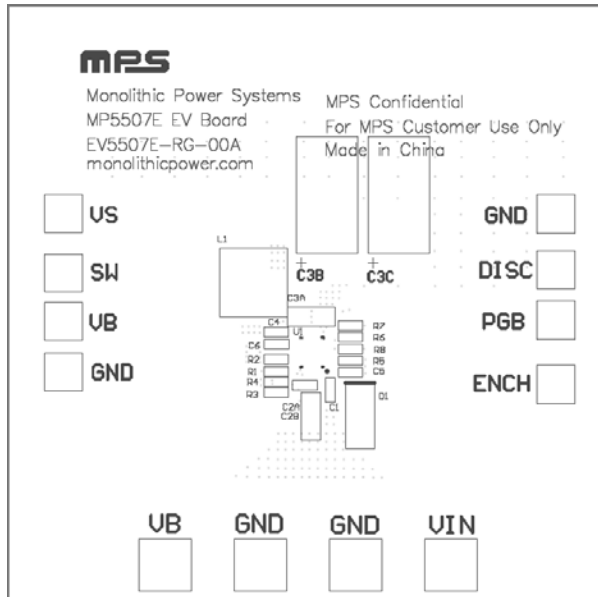

Figure 1—Top Silk Layer

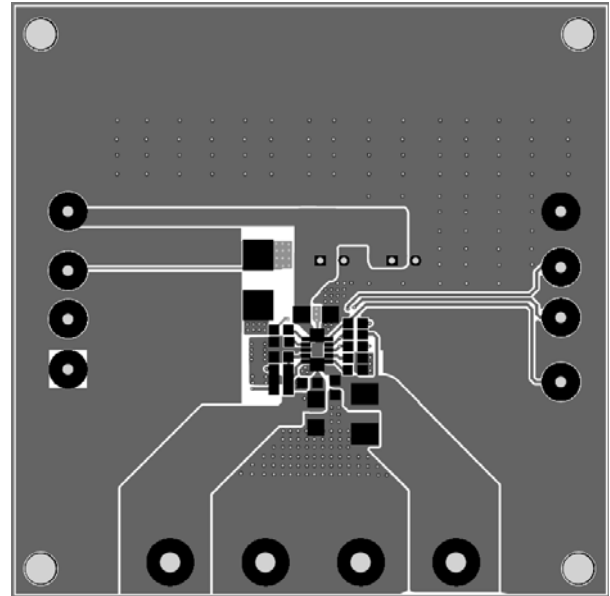

Figure 2—Top Layer

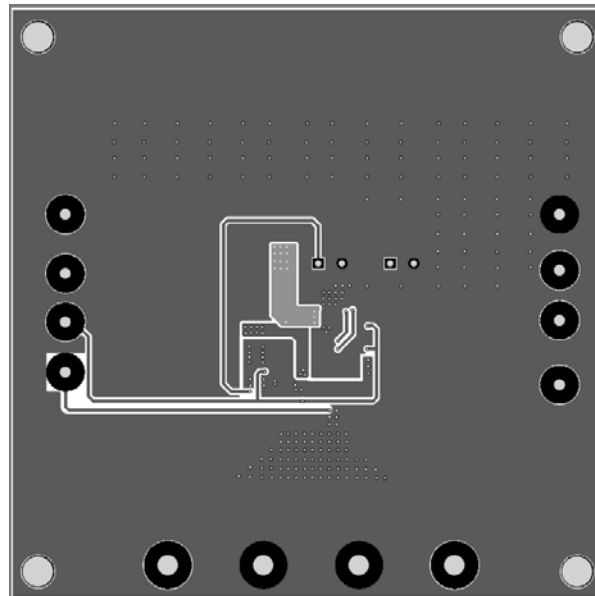

Figure 3—Bottom Layer

QUICK START GUIDE

The board layout accommodates most commonly used components.

1. Connect the positive and negative terminals of the load to VB and GND pins, respectively.
2. Preset Power Supply to 3.3V. Turn off Power Supply.
3. Connect Power Supply terminals to:
Positive (+): VIN
Negative (-): GND
4. Turn on Power Supply after making connections, MP5507E will charge the storage capacitor to 12V after DCDC converter completes start-up.
5. In order to observe the power release performance, following two methods can be applied:
Turning off the power supply.
Short VIN to GND directly. Note: make sure bench power supply have output current limiting when do so.
6. Use R1 and R2 to set release voltage:

$$V_{\text{RELEASE}} = 0.79\text{V} \times \frac{R1+R2}{R2}$$

Similarly, R3 and R4 can be chosen for storage voltage setting:

$$V_{\text{STORAGE}} = 0.79\text{V} \times \frac{R3+R4}{R4}$$

NOTICE: The information in this document is subject to change without notice. Please contact MPS for current specifications. Users should warrant and guarantee that third party Intellectual Property rights are not infringed upon when integrating MPS products into any application. MPS will not assume any legal responsibility for any said applications.