



EV5461-C-00A

Dual Input, 4-Switch Integrated Buck-Boost Converter with Input ORing and Selection

DESCRIPTION

The EV5461-C-00A Evaluation Board is designed to demonstrate the capabilities of MPS' MP5461, which is a dual input, 4-switch integrated buck-boost converter. It's capable of regulating the output voltage from 4.2V to 5.5V VIN1 and 2.5V to 5.5V VIN2. The VIN1 can support up to 22V input voltage but is not functional after >5.75V.

MP5461 has two auto-ORing switches from VIN1 and VIN2 to get a stable input for Buck-Boost converter. The two sets of ORing MOSFETs are integrated. If one channel power source falls, the fast turn-off protection minimizes the reverse current.

The Buck-Boost converter can operate from an input voltage above, equal to, or below the output voltage. It uses current-mode control with 1.8MHz fixed PWM frequency to optimize stability and transient response. In light load condition, it enters PFM mode to get high light load efficiency. Integrated MOSFETs minimize the solution size while maintaining high efficiency. Fault protection includes VIN1 OVP shutdown, output hiccup current limiting and thermal shutdown. The MP5461 is available.

ELECTRICAL SPECIFICATION

Parameter	Symbol	Value	Units
Input Voltage 1	VIN1	4.2 – 5.5	V
Input Voltage 2	VIN2	2.5 – 5.5	V
Output Voltage	VOOUT	3.3	V
Output Current	Iout	0.5	A
Switching frequency	Fs	1.8	MHZ

FEATURES

- Dual Input ORing Switches:
 - 4.2V to 5.5V Input-Voltage Range for VIN1
 - Support 22V Voltage Stress for VIN1
 - 5.75V OVP Shutdown for VIN1
 - 2.5V to 5.5V Input-Voltage Range for VIN2
 - Fast Reverse Block within 2us
 - 1A Current Capability for each channel
 - Soft-start Control
 - Fast SCP(Short Circuit Protection) on OR_OUT
 - Power Path Selection Input
 - Power Path Status Indication
- Buck-Boost Converter
 - 1.8MHz Switching Frequency for CCM
 - 3.3V Fixed Output Voltage
 - 500mA Continuous Output Current
 - 1ms Soft-start Time
 - Auto PFM/PWM Mode
 - Output over Voltage Protection
 - Hiccup over Current Protection
- 1µA Shutdown Current
- 200µA Quiescent Current
- Active Low System EN pin
- EN to OR_OUT startup delay 300us
- Over Temperature Shutdown
- Available in a Wafer Level Chip Scale Packaging: CSP-12(1.4mmx1.8mm)

APPLICATIONS

- USB-C Cable
- VCONN Powered USB Device

All MPS parts are lead-free, halogen free, and adhere to the RoHS directive. For MPS green status, please visit MPS website under Quality Assurance. "MPS" and "The Future of Analog IC Technology" are Registered Trademarks of Monolithic Power Systems, Inc.

EV5461-C-00A EVALUATION BOARD



Total solution size
(L x W) 6.9mm x 7.2mm

Board Number	MPS IC Number
EV5461-C-00A	MP5461GC

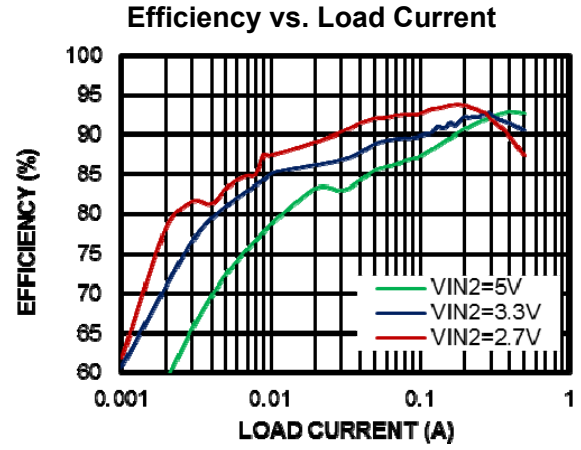

EVALUATION BOARD SCHEMATIC

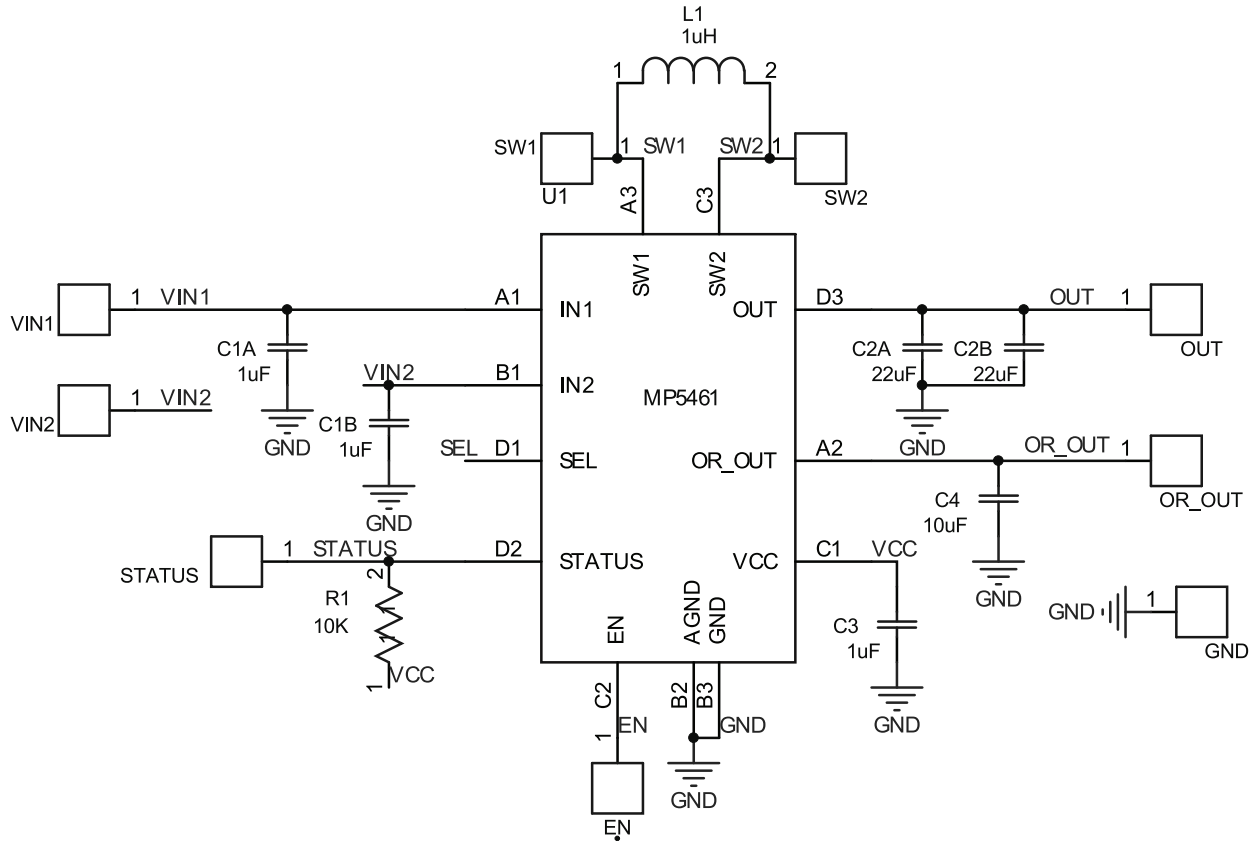

EV5461-C-00A BILL OF MATERIALS

Qty	RefDes	Value	Description	Package	Manufacturer	Manufacturer_P/N
2	C1A,C1B	1 μ F	Ceramic Cap.,25V,X5R	0402	Murata	GRM155R61E105KA12D
2	C2A, C2B	22 μ F	Ceramic Cap.,6.3V,X6S	0603	Murata	GRT188C80J226ME13D
1	C3	1 μ F	Ceramic Cap.,10V,X5R	0402	WE	885012105012
1	R1	10k	Film Res, 1%,0402,10K	0402	YAGEO	RC0402FR-0710KL
1	C4	10 μ F	Ceramic Cap., 6.3V,X5R	0402	Murata	GRM155R60J106ME44D
1	L1	1 μ H	1 μ H inductor	SMT	Murata	DFE252012R-H-1R0M
1	U1	MP5461	CSP-12, dual input buck-boost DC-DC converter	CSP-12	MPS	MP5461GC
6	GNDSENSE, STATUS, SEL, SW1, SW2, EN	1PIN	1Pin single row straight Header	DIP	WE	61300111121
7	GND*3, VIN1, VIN2, OUT,OR_OUT	ϕ 2.0	ϕ 2.0 copper pin	DIP	N/A	ϕ 2.0 copper pin

EVB TEST RESULTS

Performance waveforms are tested on the evaluation board.

VIN1 = 5V, VIN2 = 5V, VOUT = 3.3V, L = 1μH, TA = 25°C, unless otherwise noted.

VIN1 Shutdown Current vs. Temperature, VIN1 = 5V

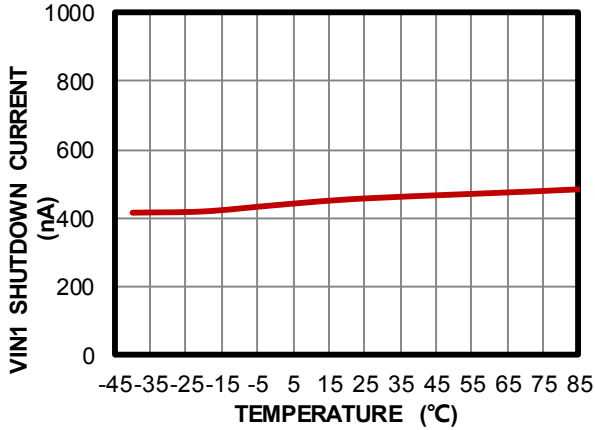

VIN2 Shutdown Current vs. Temperature, VIN2 = 5V

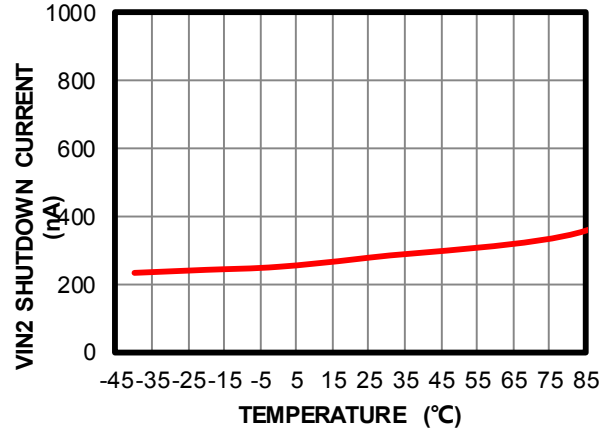

VIN1 Quiescent Current vs. Temperature, VIN1 = 5V

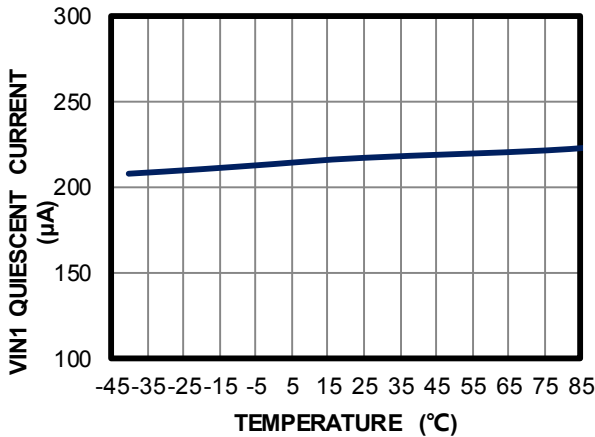

VIN2 Quiescent Current vs. Temperature, VIN2 = 5V

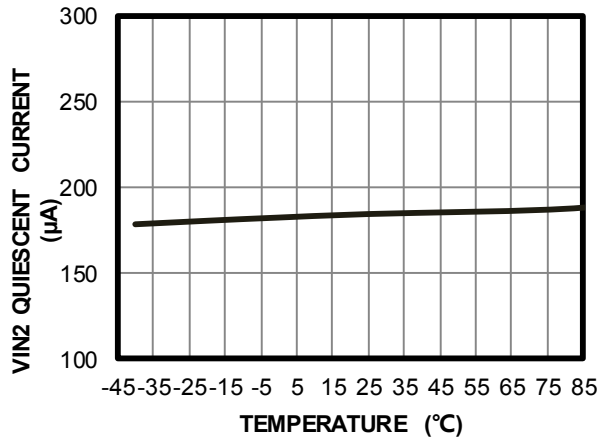

VCC Voltage vs. Temperature

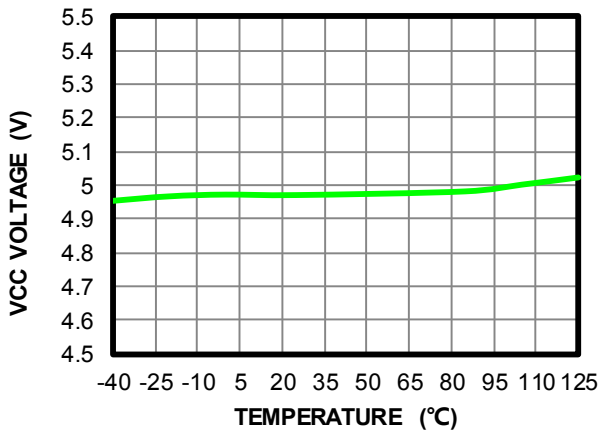

Efficiency vs. Load Current

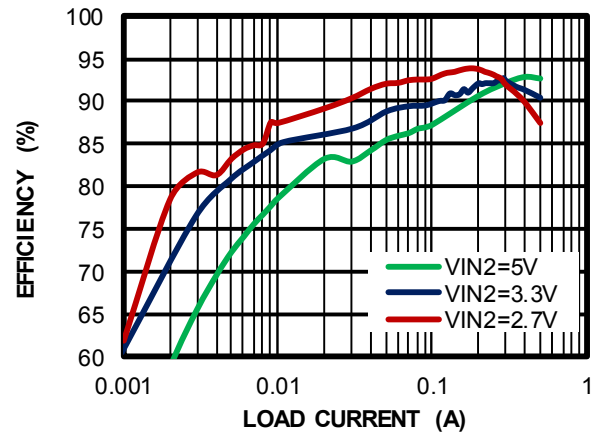

TYPICAL PERFORMANCE CHARACTERISTICS (continued)

$V_{IN1} = 5V$, $V_{IN2} = 5V$, $V_{OUT} = 3.3V$, $L = 1\mu H$, $T_A = 25^\circ C$, unless otherwise noted.

Load Regulation

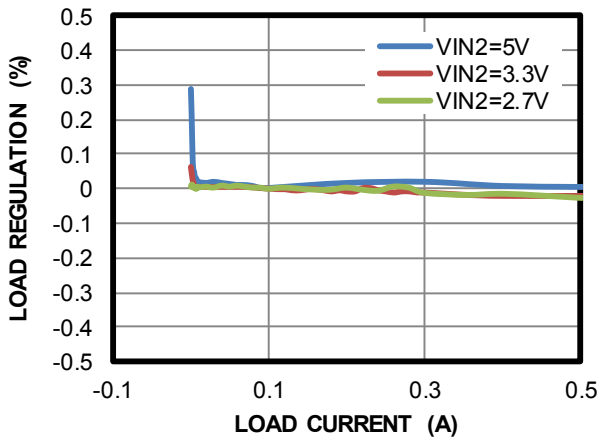

Line Regulation

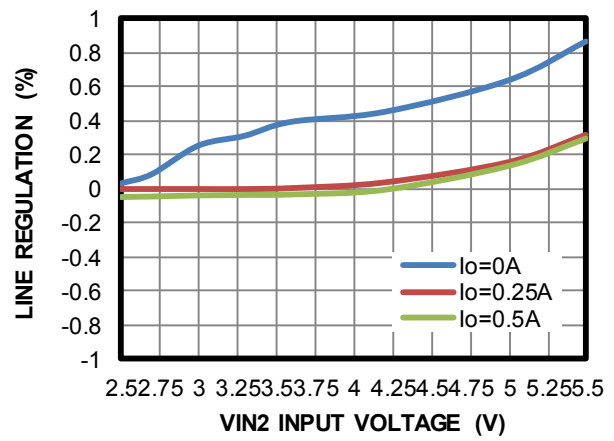

TYPICAL PERFORMANCE CHARACTERISTICS (continued)

$V_{IN1} = 5V$, $V_{IN2} = 5V$, $V_{OUT} = 3.3V$, $L = 1\mu H$, $T_A = 25^\circ C$, unless otherwise noted.

Output Ripple

$V_{IN1}=5V$, $V_{IN2}=Float$, $V_{OUT}=3.3V$, $I_{OUT}=0A$

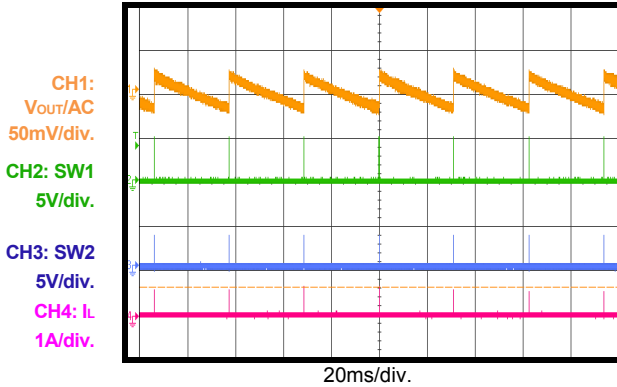

Output Ripple

$V_{IN1}=5V$, $V_{IN2}=Float$, $V_{OUT}=3.3V$, $I_{OUT}=0A$

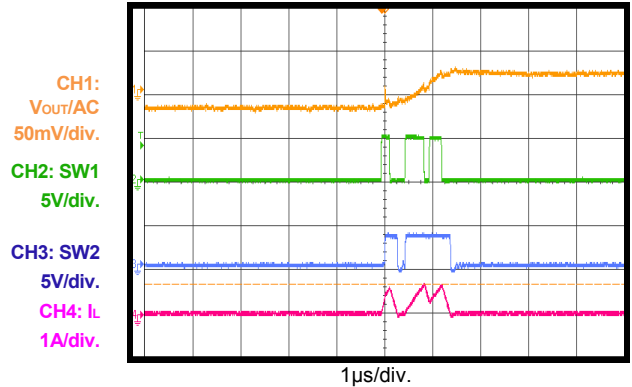

Output Ripple

$V_{IN1}=5V$, $V_{IN2}=Float$, $V_{OUT}=3.3V$, $I_{OUT}=0.5A$

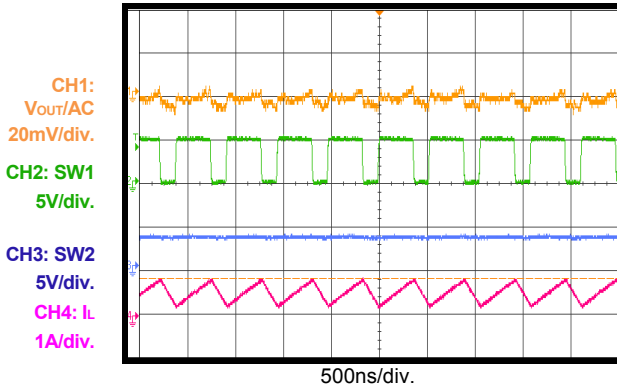

Output Ripple

$V_{IN2}=5V$, $V_{IN1}=Float$, $V_{OUT}=3.3V$, $I_{OUT}=0.5A$

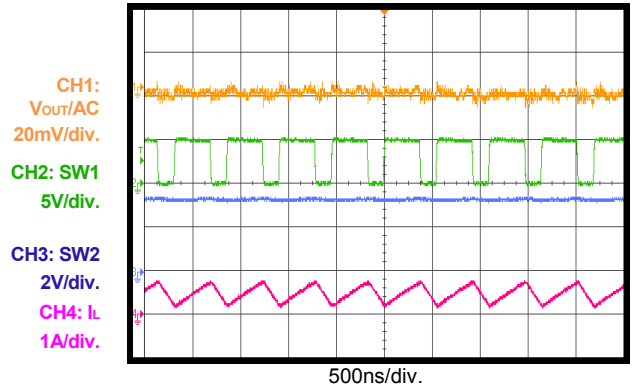

Output Ripple

$V_{IN2}=3.3V$, $V_{IN1}=Float$, $V_{OUT}=3.3V$, $I_{OUT}=0.5A$, Buck-boost mode

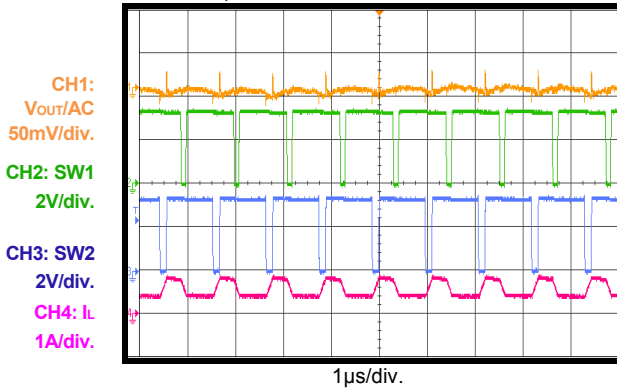

Output Ripple

$V_{IN2}=2.5V$, $V_{IN1}=Float$, $V_{OUT}=3.3V$, $I_{OUT}=0.5A$, Boost mode

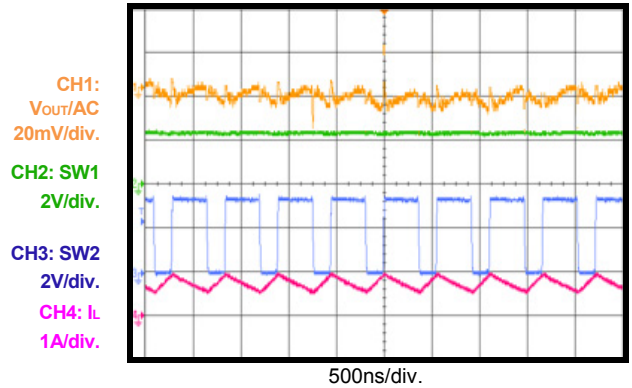

TYPICAL PERFORMANCE CHARACTERISTICS (continued)

$V_{IN1} = 5V$, $V_{IN2} = 5V$, $V_{OUT} = 3.3V$, $L = 1\mu H$, $T_A = 25^\circ C$, unless otherwise noted.

Power Start-Up

$V_{IN1}=5V$, $V_{IN2}=Float$, $V_{OUT}=3.3V$, $I_{OUT}=0A$

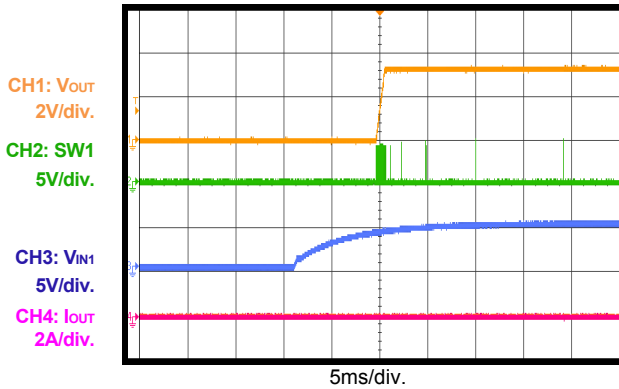

Power Start-Up

$V_{IN1}=5V$, $V_{IN2}=Float$, $V_{OUT}=3.3V$, $I_{OUT}=0.5A$

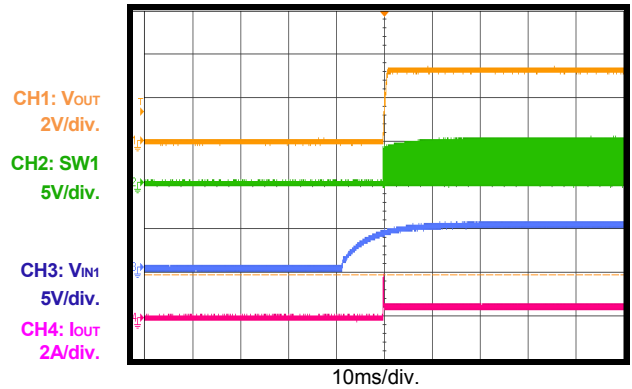

Power Shutdown

$V_{IN1}=5V$, $V_{IN2}=Float$, $V_{OUT}=3.3V$, $I_{OUT}=0A$

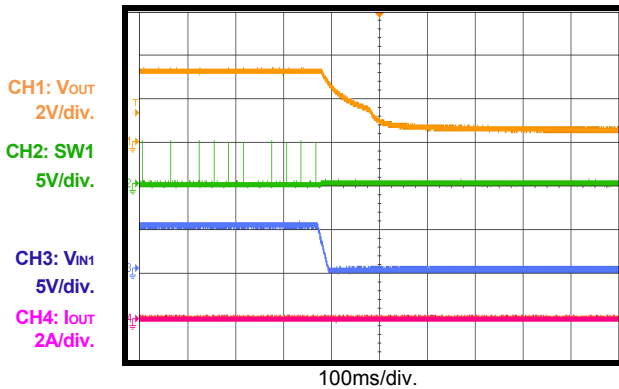

Power Shutdown

$V_{IN1}=5V$, $V_{IN2}=Float$, $V_{OUT}=3.3V$, $I_{OUT}=0.5A$

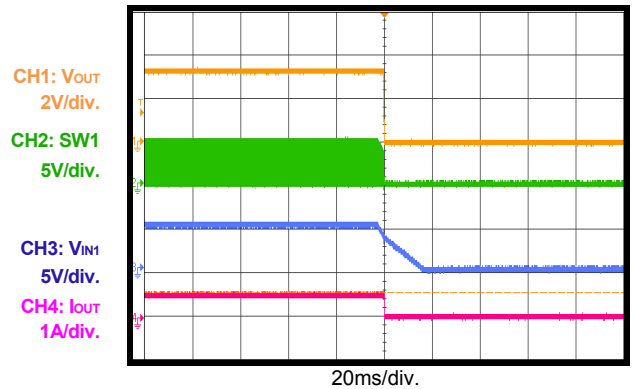

EN Start-Up

$V_{IN1}=5V$, $V_{IN2}=Float$, $V_{OUT}=3.3V$, $I_{OUT}=0A$

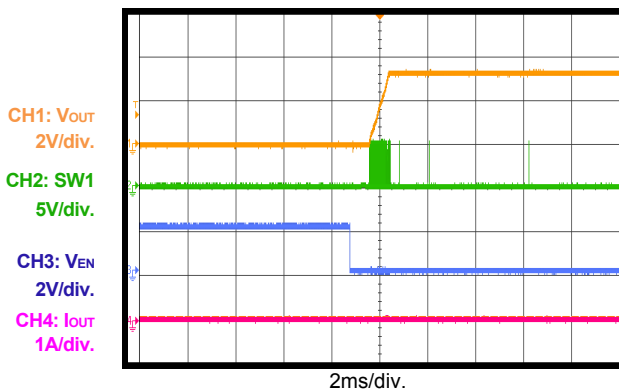

EN Start-Up

$V_{IN1}=5V$, $V_{IN2}=Float$, $V_{OUT}=3.3V$, $I_{OUT}=0.5A$

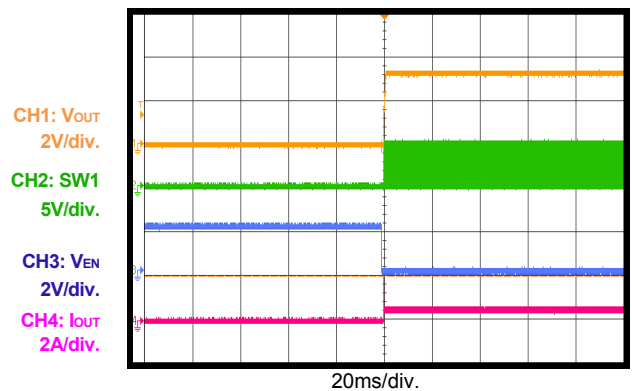

TYPICAL PERFORMANCE CHARACTERISTICS (continued)

$V_{IN1} = 5V$, $V_{IN2} = 5V$, $V_{OUT} = 3.3V$, $L = 1\mu H$, $T_A = 25^\circ C$, unless otherwise noted.

EN Shutdown

$V_{IN1}=5V$, $V_{IN2}=Float$, $V_{OUT}=3.3V$, $I_{OUT}=0A$

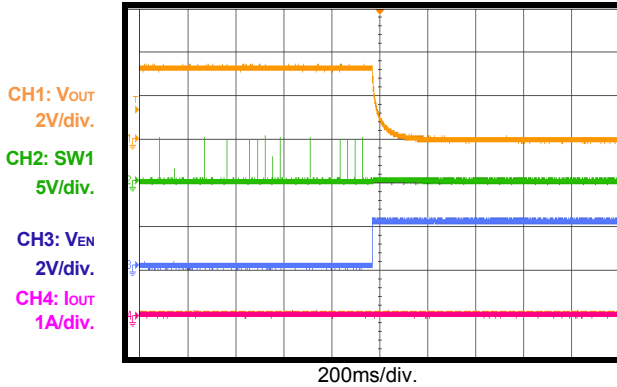

EN Shutdown

$V_{IN1}=5V$, $V_{IN2}=Float$, $V_{OUT}=3.3V$, $I_{OUT}=0.5A$

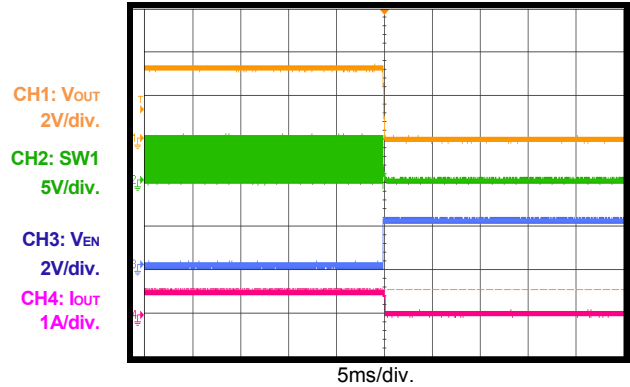

Input Voltage Selection by SEL pin

$V_{IN1}=5V$, $V_{IN2}=2.5V$, $V_{OUT}=3.3V$, $I_{OUT}=0.2A$, SEL from Low to High

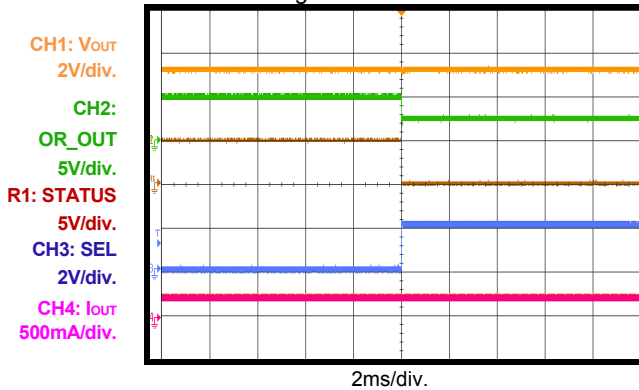

Input Voltage Selection by SEL pin

$V_{IN1}=5V$, $V_{IN2}=2.5V$, $V_{OUT}=3.3V$, $I_{OUT}=0.2A$, SEL from High to Low

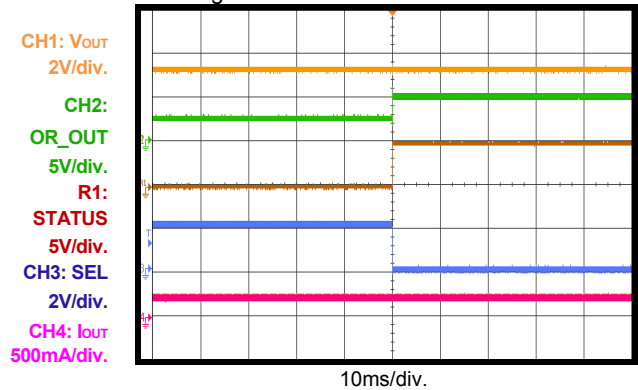

Load Transient

$V_{IN1}=5V$, $V_{IN2}=Float$, $V_{OUT}=3.3V$, $I_{OUT}=0A-0.5A$, 200mA/ μs

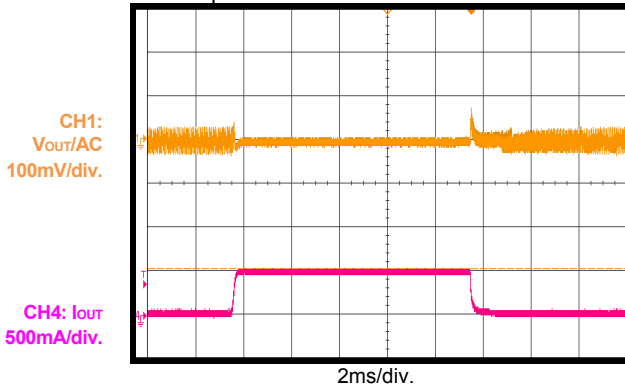

SCP Entry

$V_{IN1}=5V$, $V_{IN2}=Float$, $V_{OUT}=3.3V$, short output to GND.

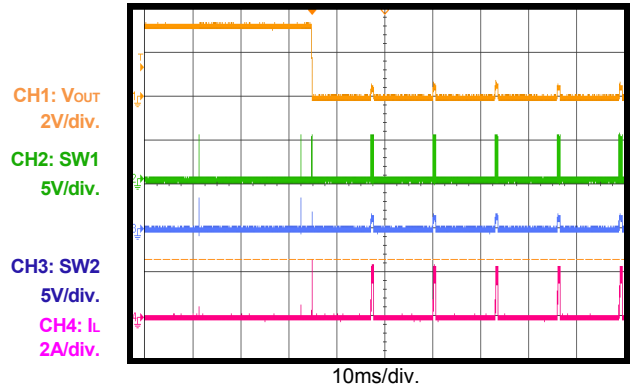

TYPICAL PERFORMANCE CHARACTERISTICS (continued)

$V_{IN1} = 5V$, $V_{IN2} = 5V$, $V_{OUT} = 3.3V$, $L = 1\mu H$, $T_A = 25^\circ C$, unless otherwise noted.

SCP Recovery

$V_{IN1}=5V$, $V_{IN2}=Float$, $V_{OUT}=3.3V$, short output to GND

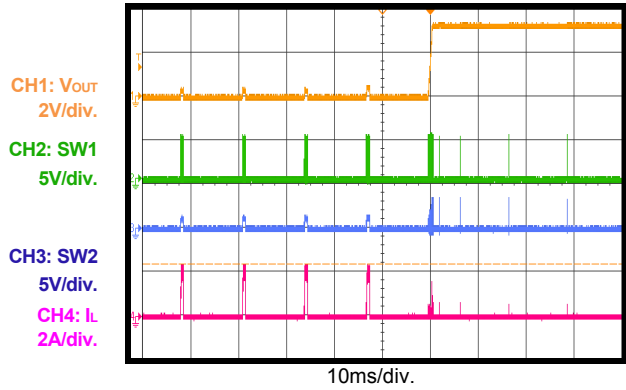

PRINTED CIRCUIT BOARD LAYOUT

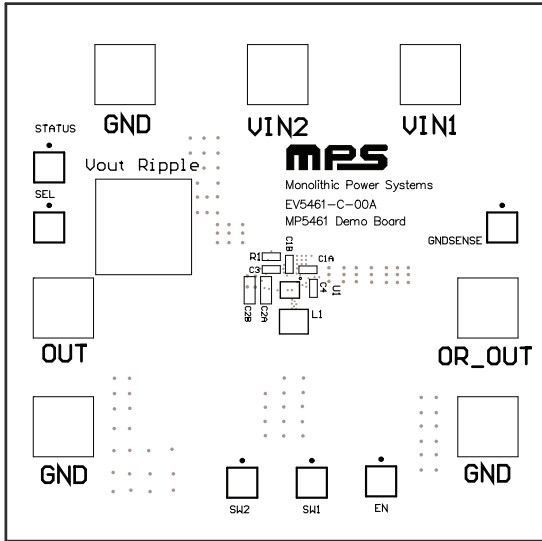

Figure 1: Top Silk Layer

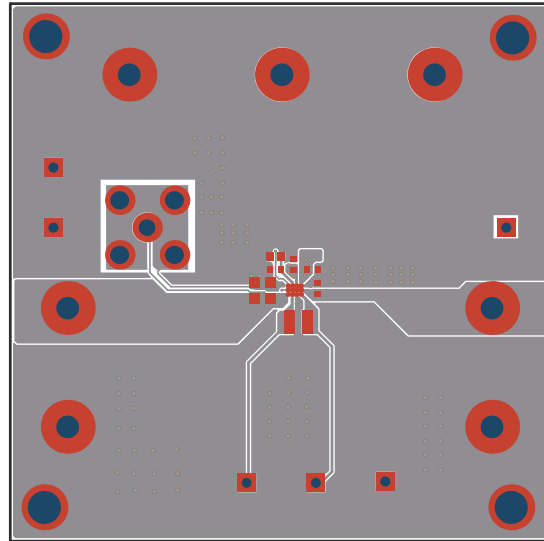

Figure 2: Top Layer

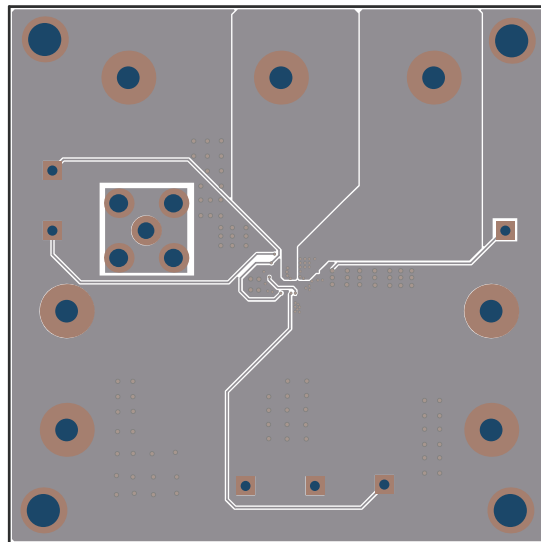

Figure 3: Bottom Layer

QUICK START GUIDE

1. Preset Power Supply to VIN1 or VIN2=5V.
2. Turn Power Supply off.
3. Connect Power Supply terminals to:
 - a. Positive (+): VIN1 or VIN2
 - b. Negative (-): GND
4. Connect Load to:
 - a. Positive (+): VOUT
 - b. Negative (-): GND
5. Turn Power Supply on after making connections. The board will automatically start up.
6. When VIN1 and VIN2 are both power supplied, MP5461 input power path is determined by SEL pin status. SEL=Low or Float, the VIN1 is selected; SEL=High, the VIN2 is selected.

NOTICE: The information in this document is subject to change without notice. Please contact MPS for current specifications. Users should warrant and guarantee that third party Intellectual Property rights are not infringed upon when integrating MPS products into any application. MPS will not assume any legal responsibility for any said applications.