

## DESCRIPTION

The EV5416-R-00B is an evaluation board for MP5416, a complete power management solution which integrates four high efficiency step-down DC/DC converters, five low dropout regulators and flexible logic interface.

COT control DC/DC converter provides fast transient response. 1.5MHz default fixed switching frequency during CCM mode greatly reduces external inductor and capacitor value. Full protection features include UVLO, OCP and thermal shutdown.

Output voltage is adjustable through I2C bus or preset by OTP (One Time Programmable). The power on/off sequence is also programmable by OTP or can be controlled through I2C bus online.

The MP5416 requires a minimal number external components, and is available in space-saving 28-pin QFN28 (4x4mm) package. Electrical Specification

## FEATURES

- **High Efficiency Step-Down Converters**
  - Buck1: 4.5A DC/DC Converter
  - Buck2: 2.5A DC/DC Converter
  - Buck3: 4A DC/DC Converter
  - Buck4: 2A DC/DC Converter
  - 2.8V to 5.5V Operating Input Range
  - Adjustable Switching Frequency
  - Programmable Forced PWM/Auto PFM/PWM Mode
  - Hiccup Over Current Protection
- **Low Dropout Regulators**
  - One RTC Dedicate LDO
  - Four Low Noise LDOs
  - Two Separate Input Power Supplies
  - 100mV Dropout at 300mA Load
- **System**
  - I2C Bus and OTP
  - Power On/off Button
  - Power On Reset Output
  - Flexible Power On/off Sequence via OTP
  - Flexible DC/DC, LDO On/off via OTP
  - ±4kV HBM and ±2kV CDM ESD Rating for all pins

## APPLICATIONS

- Cable Modem, Set-Top-Box
- TV
- MID, Tablet
- POS Machine
- SSD
- IP Camera

All MPS parts are lead-free and adhere to the RoHS directive. For MPS green status, please visit MPS website under Products, Quality Assurance page. "MPS" and "The Future of Analog IC Technology" are registered trademarks of Monolithic Power Systems, Inc.

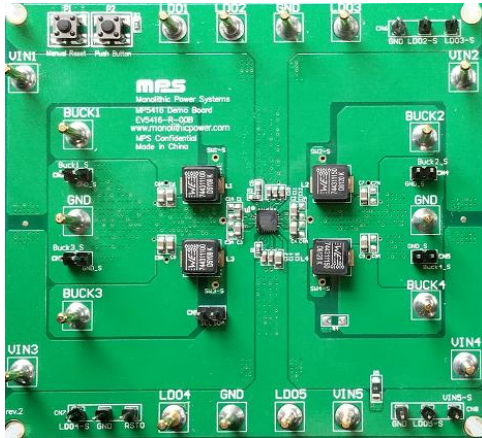
**EV5416-R-00B EVALUATION BOARD**

**(L X W ) 9.4CM X 8.6CM**

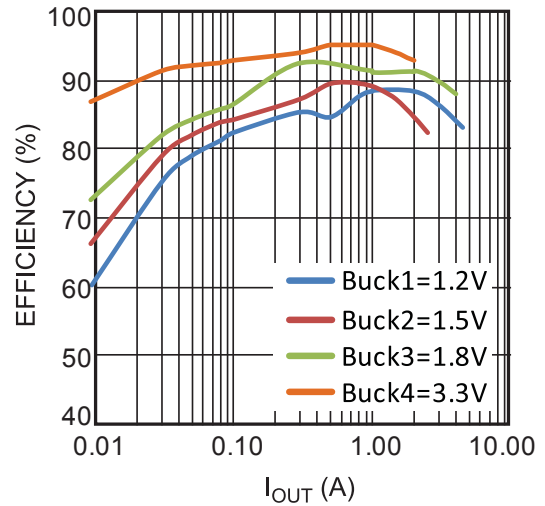
<b>Board Number</b>	<b>MPS IC Number</b>
EV5416-R-00B	MP5416GR-0001

**Efficiency vs. Load Current**
 $V_{IN}=5V$ , Auto PFM/PWM Mode

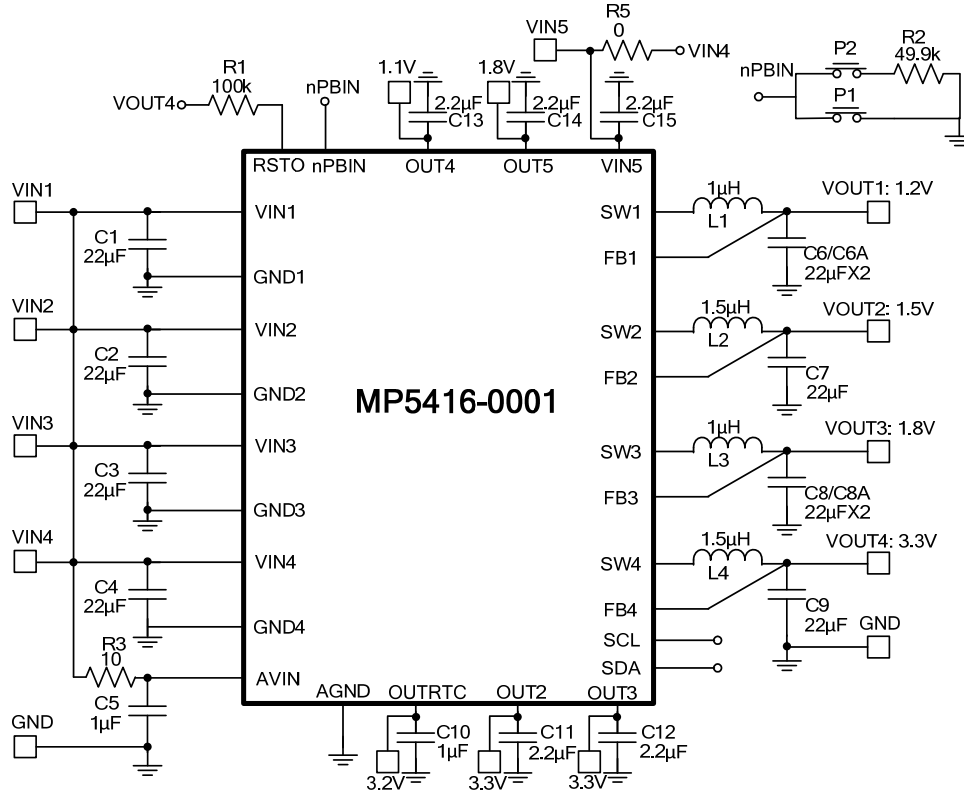
**OTP-EFUSE SELECTED TABLE BY DEFAULT**

OTP Items	Buck 1	Buck 2	Buck 3	Buck 4	LDORTC	LDO2	LDO3	LDO4	LDO5
Output Voltage	1.2V	1.5V	1.8V	3.3V	3.2V	3.3V	3.3V	1.1V	1.8V
Initial On/Off	On	On	On	On	On	On	Off	On	On
Mode	FPWM	PFM	FPWM	FPWM	N/A				
Power-On Delay/Time Slot #	2ms/1	4ms/2	4ms/2	0ms/0	Always on	4ms/2	6ms/3	2ms/1	4ms/2
Automatic Turn-On	Yes								
Switching Frequency	1.5MHz								
Push-Button Timer	2 seconds								
RSTO Delay	10ms								
Buck 1 Peak Current Limit	6.8A								
Buck 3 Peak Current Limit	5.6A								
I <sup>2</sup> C Slave Address	0x69								
OTP Version	0100								

**EVALUATION BOARD SCHEMATIC**

**EV5416-R-00B BILL OF MATERIALS**

Qty	RefDes	Value	Description	Package	Manufacturer	Manufacturer P/N
6	C6, C6A, C7, C8, C8A, C9	22µF	Ceramic Cap,6.3V,X5R	0805	muRata	GRM21BR60J226ME39L
4	C1, C2, C3, C4	22µF	Ceramic Cap,10V,X5R	0805	muRata	GRM21BR61A106KE19L
2	C5, C10	1µF	Ceramic Cap,10V,X5R	0603	muRata	GRM188R61A105KA61D
5	C11, C12, C13, C14	2.2µF	Ceramic Cap,10V,X5R	0603	muRata	GRM188R61A225KE34
1	C15	2.2µF	Ceramic Cap,10V,X7R	0805	muRata	GRM21BR71A225KA01L
1	R1	100k	Film Res,1%	0603	ROYAL	RL0603FR-07100KL
1	R2	49.9k	Film Res,1%	0603	ROYAL	RL0603FR-0749K9L
1	R3	10Ω	Film Res,1%	0603	ROYAL	RL0603FR-0710RL
2	R5	0Ω	Film Res,1%	1206	Yageo	RL1206FR-070RL
2	L1, L3	1µH	Inductor, DCR=4.6mΩ, Is=19A	SMD	Wurth	744311100
2	L2, L4	1.5µH	Inductor, DCR=6.6mΩ, Is=14A	SMD	Wurth	744311150
2	P1, P2		Tact Switch	SMD	Wurth	430181038816
1	U1		5V Power Management IC	QFN28 (4*4)	MPS	MP5416GR-0001

## EVB TEST RESULTS

Performance waveforms are tested on the evaluation board of the Design Example section.  
 $V_{IN} = 5V$ ,  $T_A = 25^\circ C$ , test using default spec parts, unless otherwise noted.

### Steady State

Each Channel Buck with Half Load

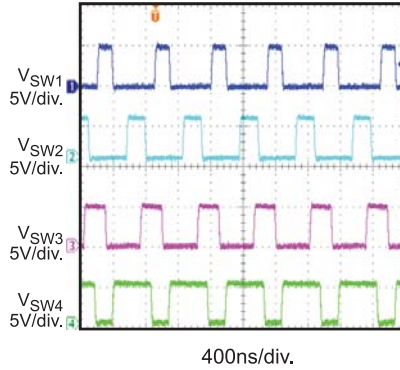

### Steady State

Each Channel Buck with Full Load

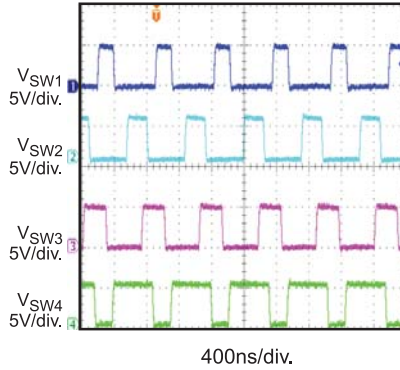

### nPBIN Power On

Each Channel Buck without Load

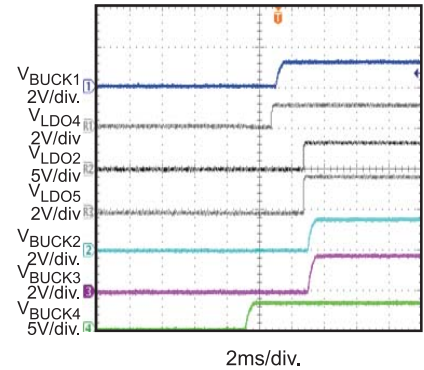

### nPBIN Power off

Each Channel Buck without Load

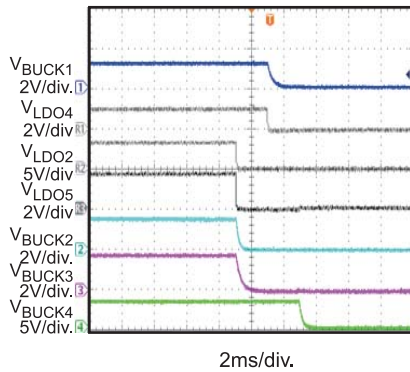

### Load Transient Response

$I_{OUT}$  Transient from 2A to 4A,  
Slew Rate=0.8A/ $\mu s$ .

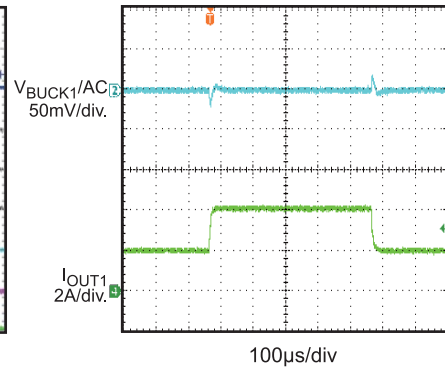

### Load Transient Response

$I_{OUT}$  Transient from 1A to 2A,  
Slew Rate=0.8A/ $\mu s$ .

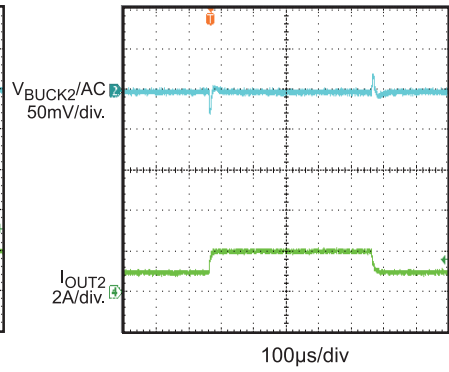

### Load Transient Response

$I_{OUT}$  Transient from 2A to 4A,  
Slew Rate=0.8A/ $\mu s$ .

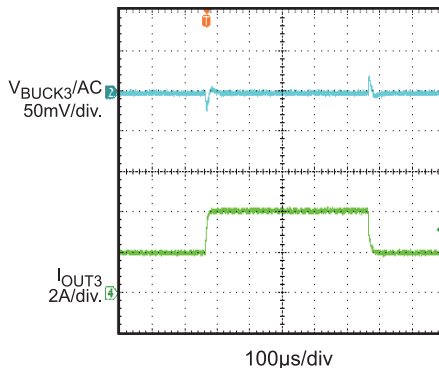

### Load Transient Response

$I_{OUT}$  Transient from 1A to 2A,  
Slew Rate=0.8A/ $\mu s$ .

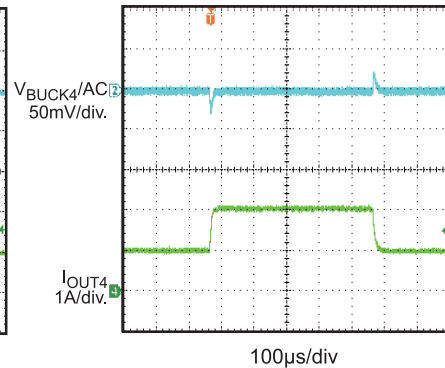

### SCP Entry

Buck-4 Output 3.3V

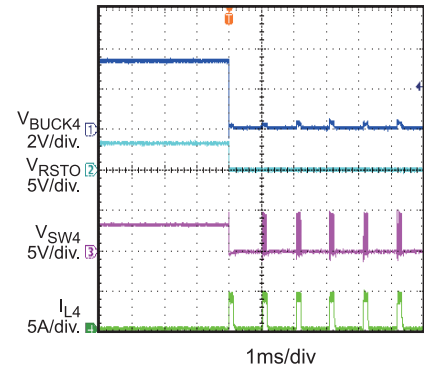

## EVB TEST RESULTS *(continued)*

Performance waveforms are tested on the evaluation board of the Design Example section.  
 $V_{IN} = 5V$ ,  $T_A = 25^\circ C$ , test using default spec parts, unless otherwise noted.

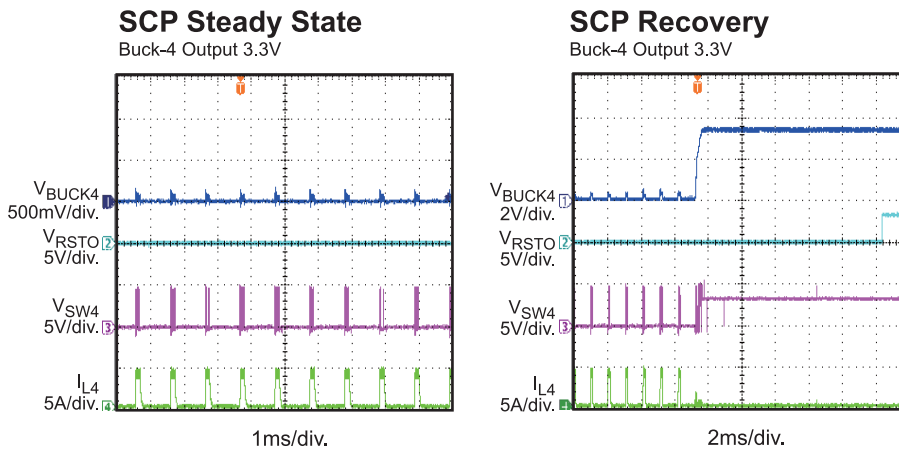

## PRINTED CIRCUIT BOARD LAYOUT

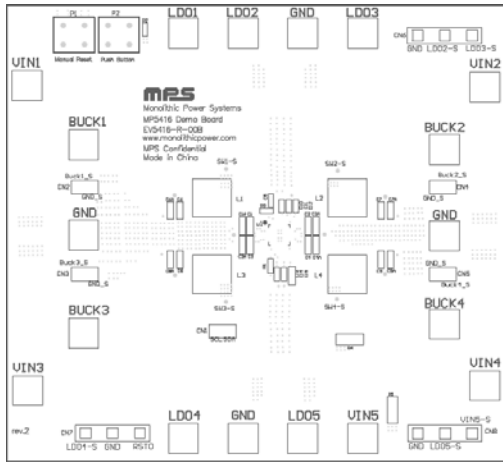

Figure 1—Top Silk Layer

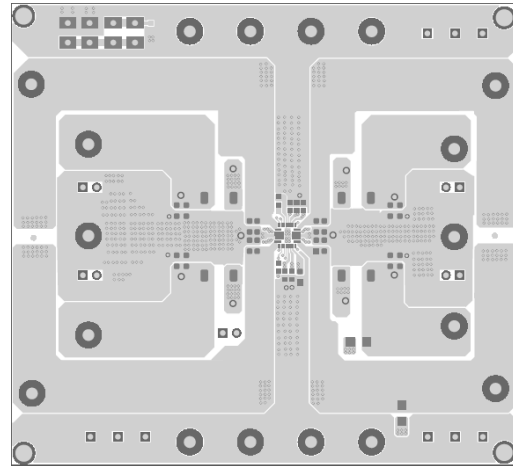

Figure 2—Top Layer

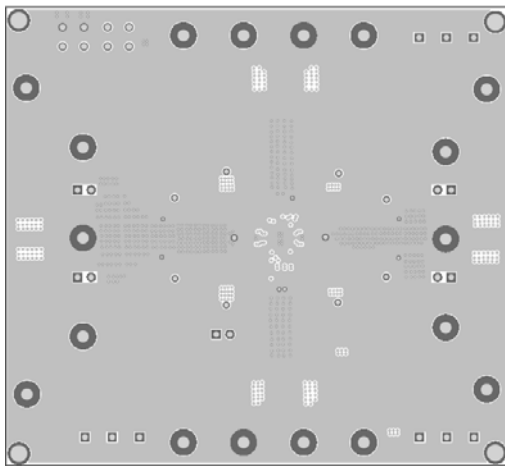

Figure 3— Inner Layer 1

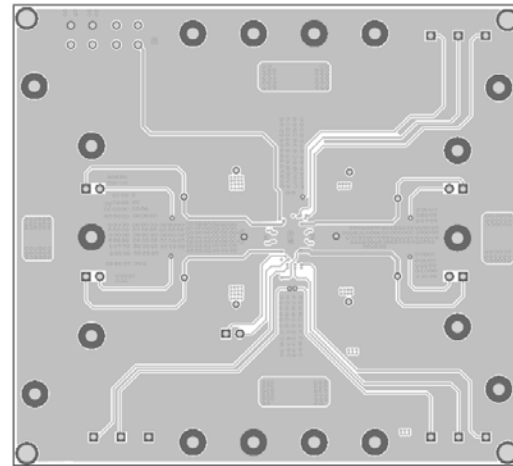

Figure 4— Inner Layer 2

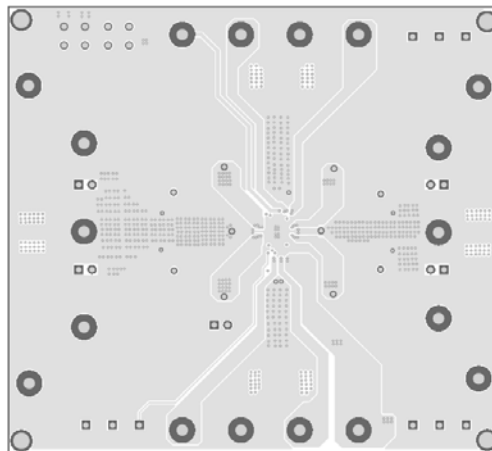

Figure 5— Bottom Layer

## QUICK START GUIDE

1. Connect the positive and negative terminals of the load to the VOUT and GND pins, respectively.
2. Preset the power supply output between 3.5V and 5V, and then turn off the power supply.
3. Connect the positive and negative terminals of the power supply output to the VIN and GND pins, respectively.
4. Turn the power supply on. The PMIC will automatically entry power on sequence.

**Notes:**

- 1) VOUT power terminals on EVB are including buck1-4; LDO1 to LDO5.
- 2) VIN1-4 terminals are shorten-circuit internally. Connect input DC voltage source to either of them is ok.

**NOTICE:** The information in this document is subject to change without notice. Please contact MPS for current specifications. Users should warrant and guarantee that third party Intellectual Property rights are not infringed upon when integrating MPS products into any application. MPS will not assume any legal responsibility for any said applications.