

DESCRIPTION

The EV5087-G-00B is an evaluation board for the MP5087, a low $R_{DS(ON)}$ load switch with current monitoring

The MP5087 is a load switch, designed to provide 7A load protection covering 0.5V to 5.5V voltage range. With low $R_{DS(ON)}$ in tiny package, the MP5087 provides very high efficiency and space-saving solution for notebook, tablet and other portable applications.

The MP5087 is equipped with the very accurate current monitoring function. The gain of the current monitor can be scaled to different applications. With the soft start function, the MP5087 can avoid inrush current during circuit start-up. The MP5087 also provides other features, like power good, output discharge function, and fast short-circuit response time.

The EV board can deliver a continuous 7A load current over 0.8V to 5.5V operating input range.

ELECTRICAL SPECIFICATION

Parameter	Symbol	Value	Units
Input Voltage ⁽¹⁾	V_{IN}	0.8-5.5	V
Vcc Voltage	V_{CC}	3-5.5	V
Output Current	I_{OUT}	7	A

Note:

1) For specifications of lower voltage, please contact factory.

FEATURES

- Output Current Monitoring Accurate as High as 3%
- Wide V_{IN} Range: 0.5V to 5.5V
- <1uA Shutdown Current
- Integrated 10m Ω Low $R_{DS(ON)}$ FET
- Typical 7A Load Current Range
- Push-pull PG Indicator
- Adjustable Start Up Slew Rate
- Output Discharge Function
- <200ns Short-Circuit Response Protection
- Thermal Protection
- Small 2mmx2mm QFN Package

APPLICATIONS

- Notebook and Tablet Computers
- Portable Devices
- Solid State Drives
- Handheld Devices

All MPS parts are lead-free, halogen free, and adhere to the RoHS directive. For MPS green status, please visit MPS website under Quality Assurance. "MPS" and "The Future of Analog IC Technology" are Registered Trademarks of Monolithic Power Systems, Inc.

EV5087-G-00B EVALUATION BOARD



(L x W x H) 6.4cm x 6.4cm x 1.3cm

Board Number	MPS IC Number
EV5087-G-00B	MP5087GG

Rds_on vs.Vcc

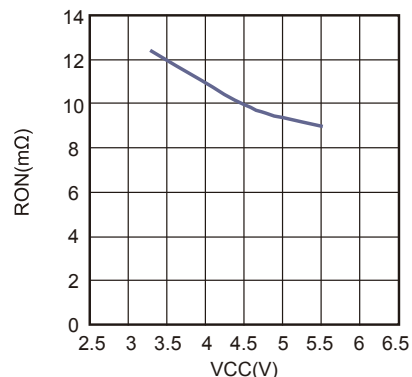

EVALUATION BOARD SCHEMATIC

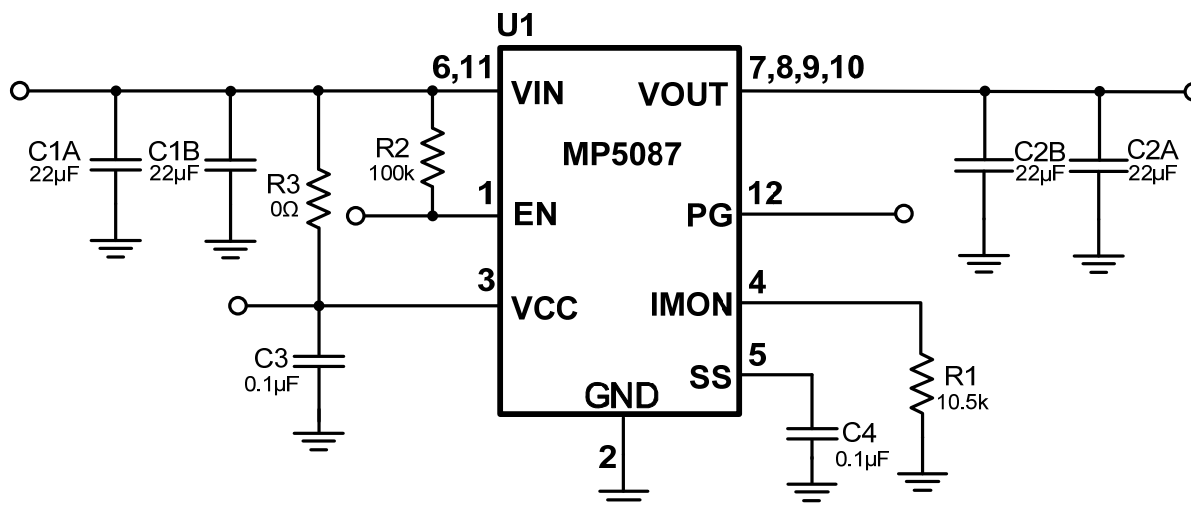

EV5087-G-00B BILL OF MATERIALS

Qty	Ref	Value	Description	Package	Manufacturer	Manufacturer P/N
1	R1	10.5kΩ	Film Res,1%	0603	ROYAL	RL0603FR-0710K5L
1	R2	100kΩ	Film Res,1%	0603	ROYAL	RL0603FR-07100KL
1	R3	0Ω	Film Res,1%	0603	ROYAL	RC0603FR-070RL
4	C1A,C1B, C2A,C2B	22µF	Ceramic Cap,10V,X5R	0805	muRata	GRM21BR61A226ME51L
2	C3,C4	0.1µF	Ceramic Cap,16V,X7R	0603	muRata	GRM188R71C104KA01D
1	U1	MP5087	7A Load Switch	QFN 2mmx2mm	MPS	MP5087GG

EVB TEST RESULTS

Performance waveforms are tested on the evaluation board.

V_{IN} = 3.6V, V_{CC} = 3.6V, EN=2.5V, R_{MON} = 10.5k, T_A = 25°C, unless otherwise noted.

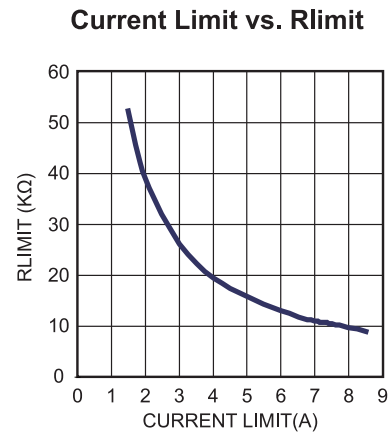
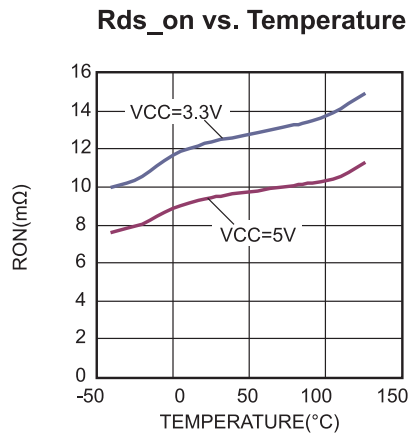
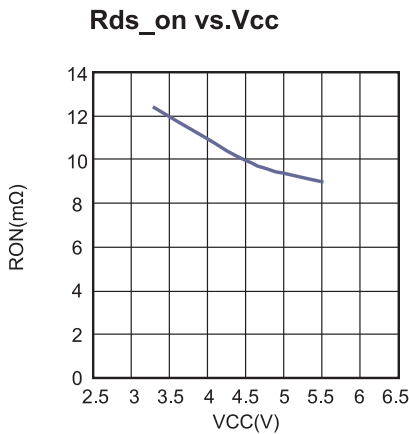
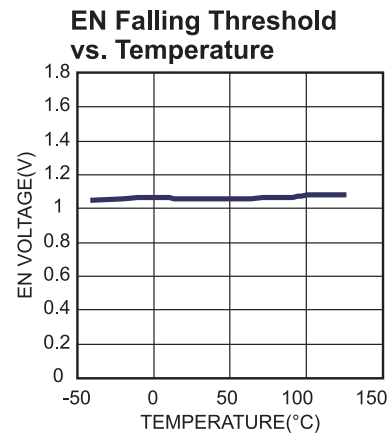
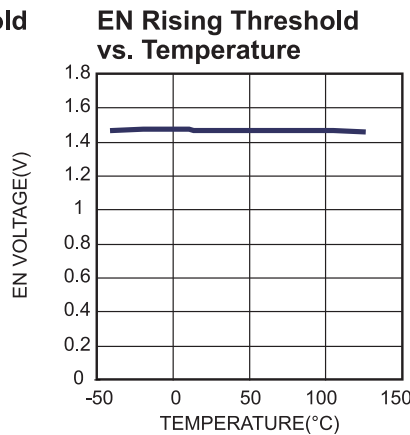
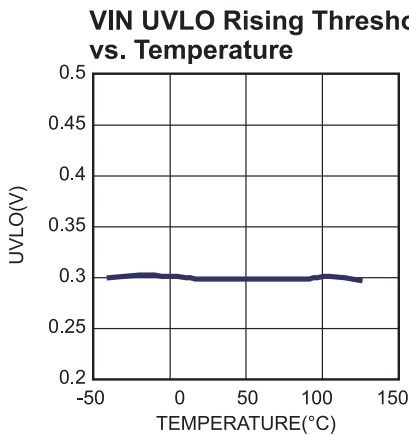
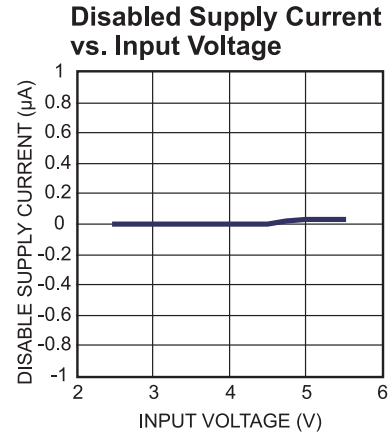
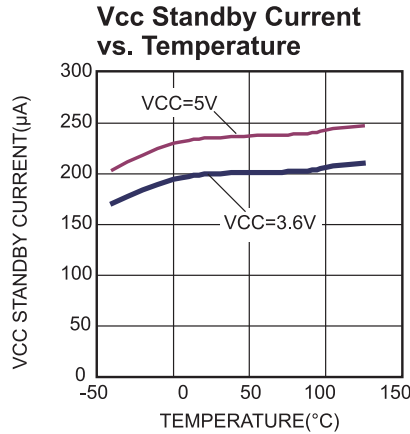
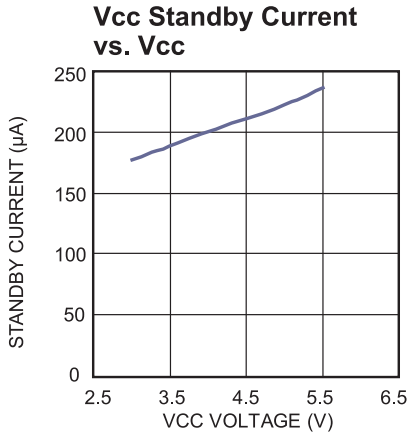

EVB TEST RESULTS (continued)

Performance waveforms are tested on the evaluation board.

$V_{IN} = 3.6V$, $V_{CC} = 3.6V$, $EN=2.5V$, $R_{IMON} = 10.5k$, $T_A = 25^\circ C$, unless otherwise noted.

I_{LIMIT} vs. Temperature

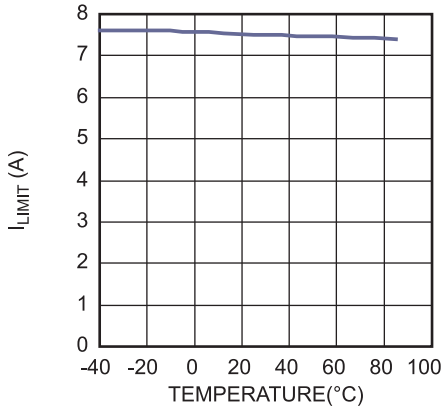

Soft-Start vs. Cap

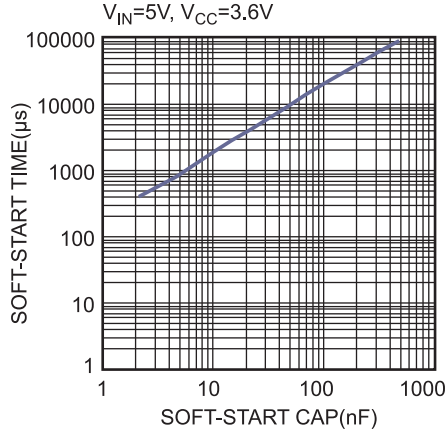

Case Temperature Rise vs. Output Current

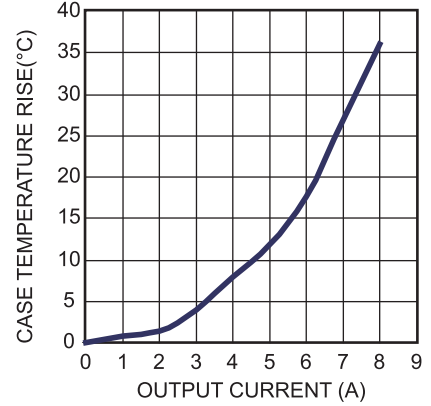

I_{MON} vs. V_{IN}

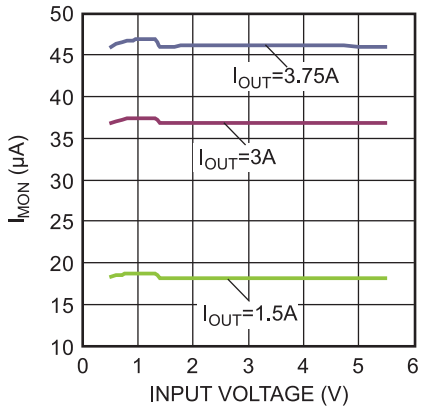

PG Rising Threshold vs. Temperature

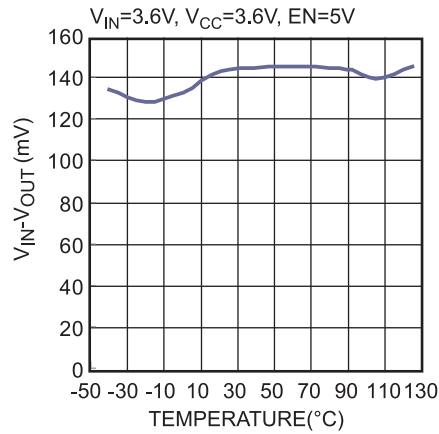

PG Hysteresis vs. Temperature

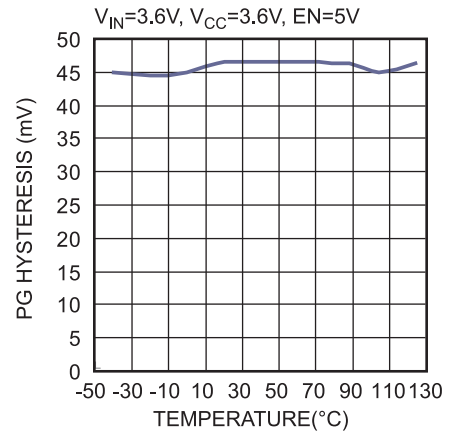

I_{MON} Accuracy vs. I_{OUT}

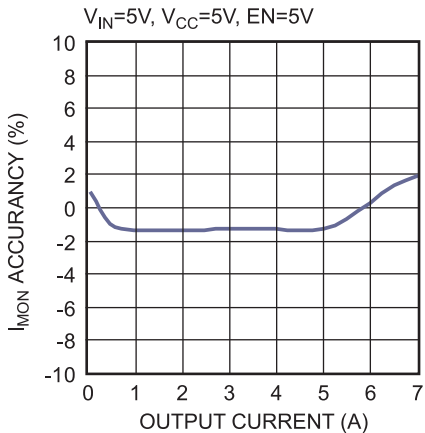

Sense Ratio vs. Temperature

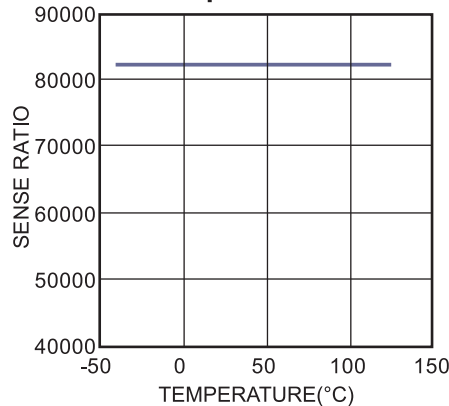

EVB TEST RESULTS (continued)

Performance waveforms are tested on the evaluation board.

$V_{IN} = 3.6V$, $V_{CC} = 3.6V$, $EN=2.5V$, $R_{IMON} = 10.5k$, $T_A = 25^{\circ}C$, unless otherwise noted.

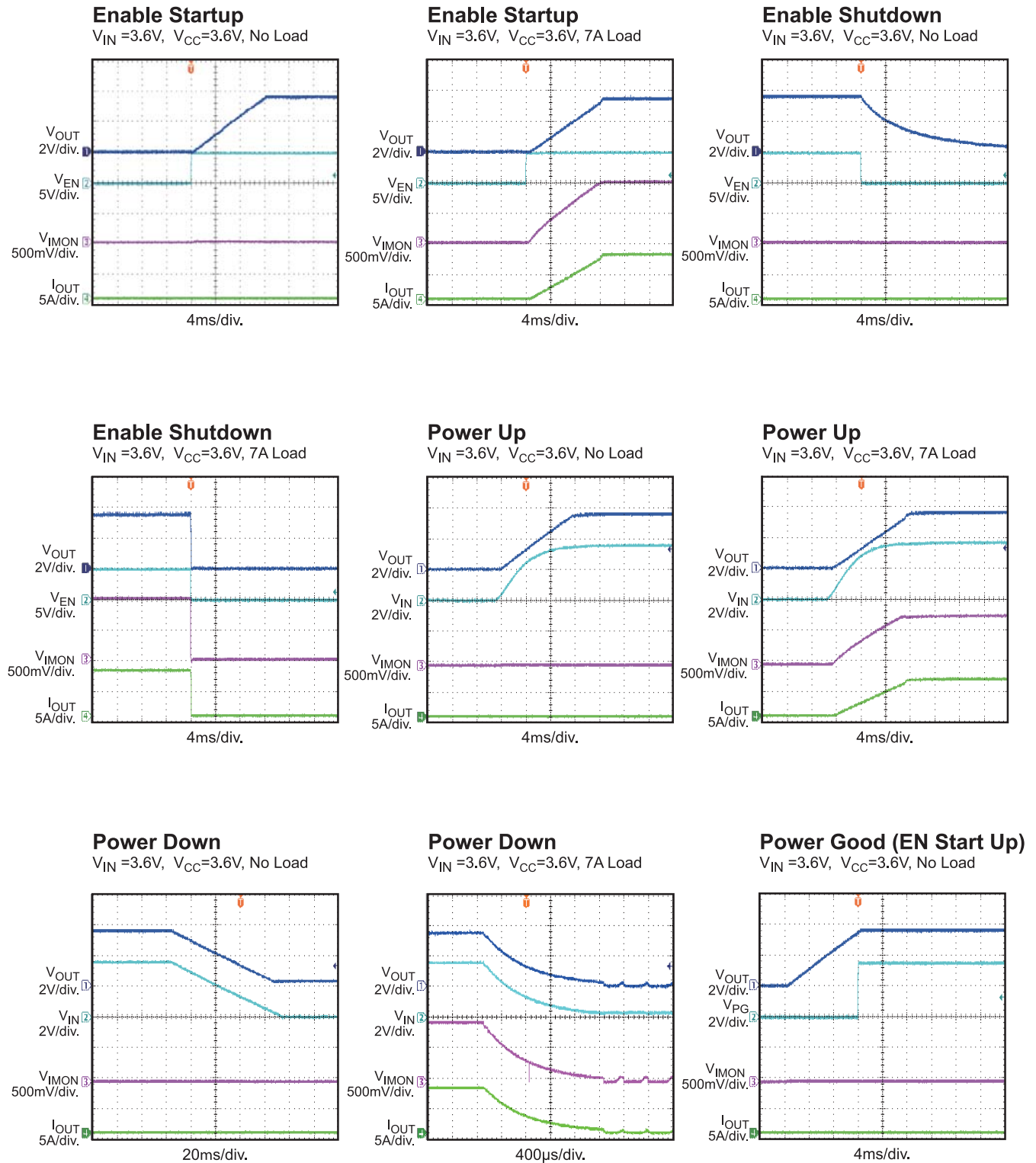

EVB TEST RESULTS (continued)

Performance waveforms are tested on the evaluation board.

$V_{IN} = 3.6V$, $V_{CC} = 3.6V$, $EN=2.5V$, $R_{IMON} = 10.5k$, $T_A = 25^{\circ}C$, unless otherwise noted.

Power Good (EN Start Up)

$V_{IN} = 3.6V$, $V_{CC} = 3.6V$, 7A Load

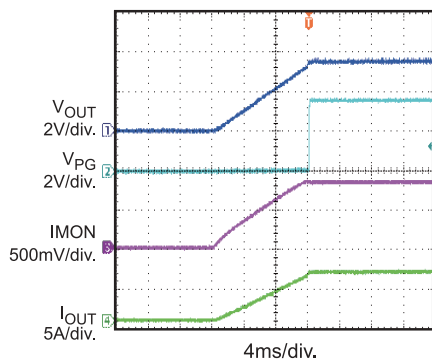

Power Good(EN Shutdown)

$V_{IN} = 3.6V$, $V_{CC} = 3.6V$, No Load

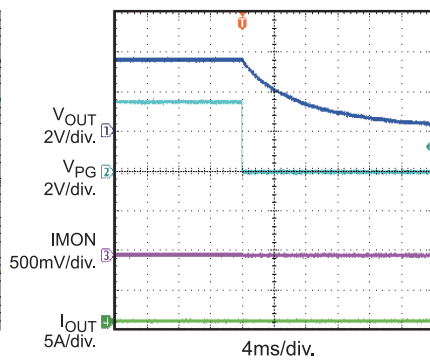

Power Good(EN Shutdown)

$V_{IN} = 3.6V$, $V_{CC} = 3.6V$, 7A Load

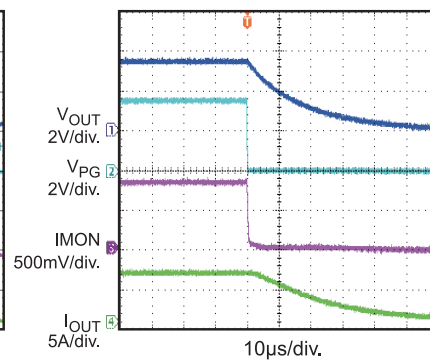

SCP Enter

$V_{IN} = 5V$, $V_{CC} = 3.3V$

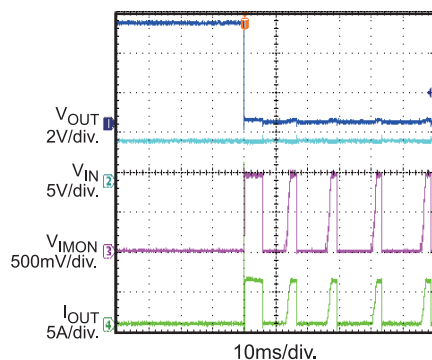

SCP Steady State

$V_{IN} = 5V$, $V_{CC} = 3.3V$

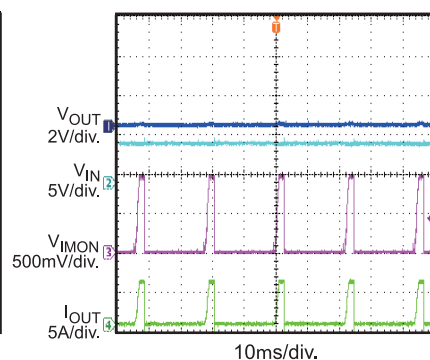

SCP Recover

$V_{IN} = 5V$, $V_{CC} = 3.3V$

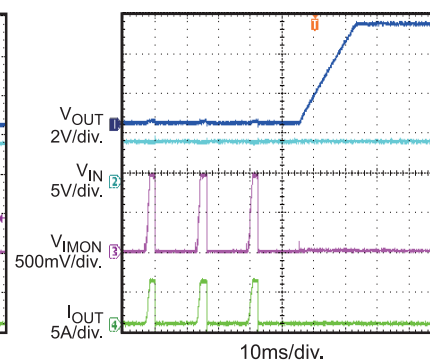

Load Transient Response

$V_{IN} = 5V$, $V_{CC} = 3.3V$, $I_{OUT} = 0A \rightarrow 7A$

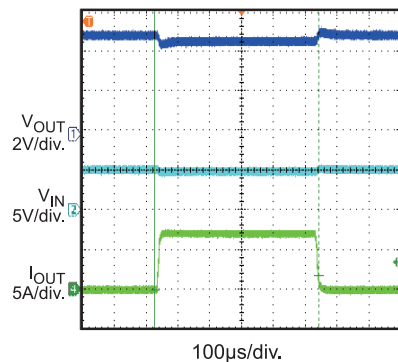

PRINTED CIRCUIT BOARD LAYOUT

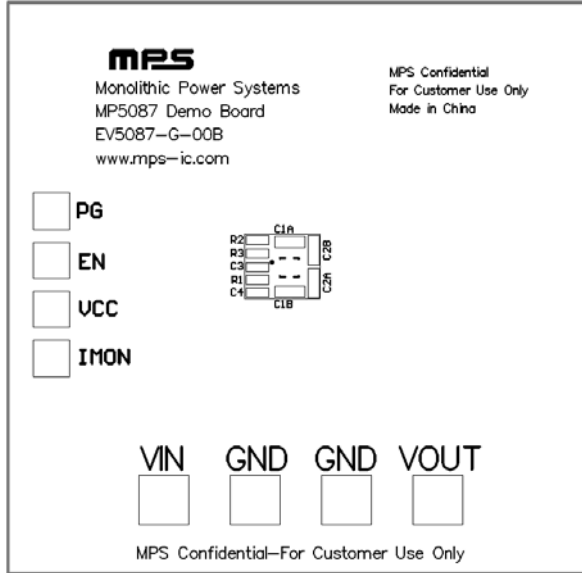

Figure1: Top Layer Silkscreen

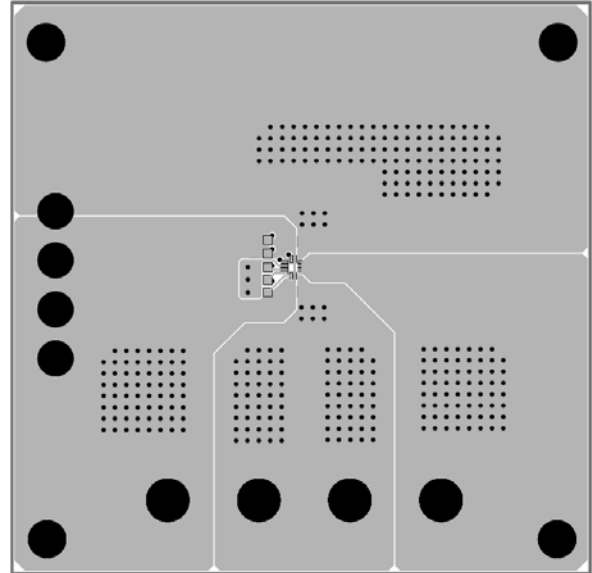

Figure2: Top Layer

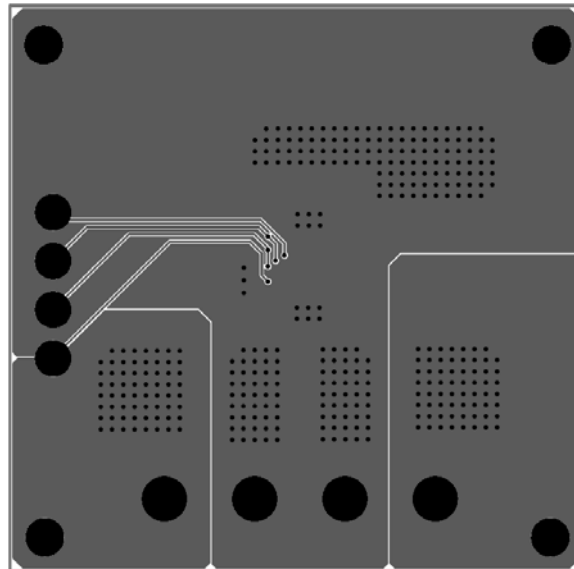

Figure3: Bottom Layer

QUICK START GUIDE

1. Connect the positive and negative terminals of the load to the V_{OUT} and GND pins, respectively.
2. Preset the power supply output between 0.8V and 5.5V, and then turn off the power supply.
3. Connect the positive and negative terminals of the power supply output to the V_{IN} and GND pins, respectively.
4. Turn the power supply on. The MP5087 will automatically startup.
5. To use the Enable function, apply a digital input to the EN pin. Drive EN higher than 1.5V to turn on the regulator or less than 1.3V to turn it off.
6. Use R1 to set the output current limit. C4 to set the SS time, Follow the Application Information section in the device datasheet to select appropriate R1, C4.

NOTICE: The information in this document is subject to change without notice. Please contact MPS for current specifications. Users should warrant and guarantee that third party Intellectual Property rights are not infringed upon when integrating MPS products into any application. MPS will not assume any legal responsibility for any said applications.