

DESCRIPTION

The MP5086 is a load switch, designed to provide 7A load protection covering 2.3V to 5.5V voltage range. With low $R_{DS(ON)}$ in tiny package, the MP5086 provides very high efficiency and space-saving solution for smart phone, tablet and other portable applications.

The MP5086 is equipped with the very accurate current monitoring function. The gain of the current monitor can be scaled for different applications. MP5086 has a NTC (Negative Temperature Coefficient Thermistor) interface. It can be used to set over temperature threshold. The MP5086 also provides other features, like fast short-circuit response time and thermal shutdown features.

The EV board can deliver a continuous 7A load current over 2.3V-to-5.5V operating input range.

ELECTRICAL SPECIFICATIONS

Parameter	Symbol	Value	Units
Input Voltage	V_{IN}	2.3-5.5	V
Output Current	I_{OUT}	7	A

FEATURES

- Output Current Monitoring Accurate High to 3%
- V_{IN} Range: 2.3V to 5.5V
- Integrated 11m Ω Low $R_{DS(ON)}$ FETs
- Typical 7A Load Current
- <1uA Supply Current at Bypass Mode
- Integrated NTC Interface
- Open-Drain OTP Indicator
- <200ns Short-Circuit Response Protection
- Thermal Protection
- Transportation Mode Available
- Small 2mmx2mm QFN Package

APPLICATIONS

- Storage Drives
- Portable/Handheld Devices
- Wireless/Networking Cards
- Low Voltage I/O System Power

All MPS parts are lead-free and adhere to the RoHS directive. For MPS green status, please visit MPS website under Products, Quality Assurance page. "MPS" and "The Future of Analog IC Technology" are registered trademarks of Monolithic Power Systems, Inc.

TYPICAL APPLICATION

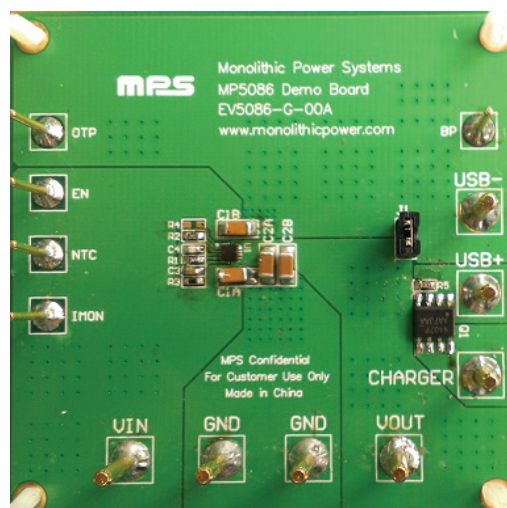

EVALUATION BOARD SCHEMATIC

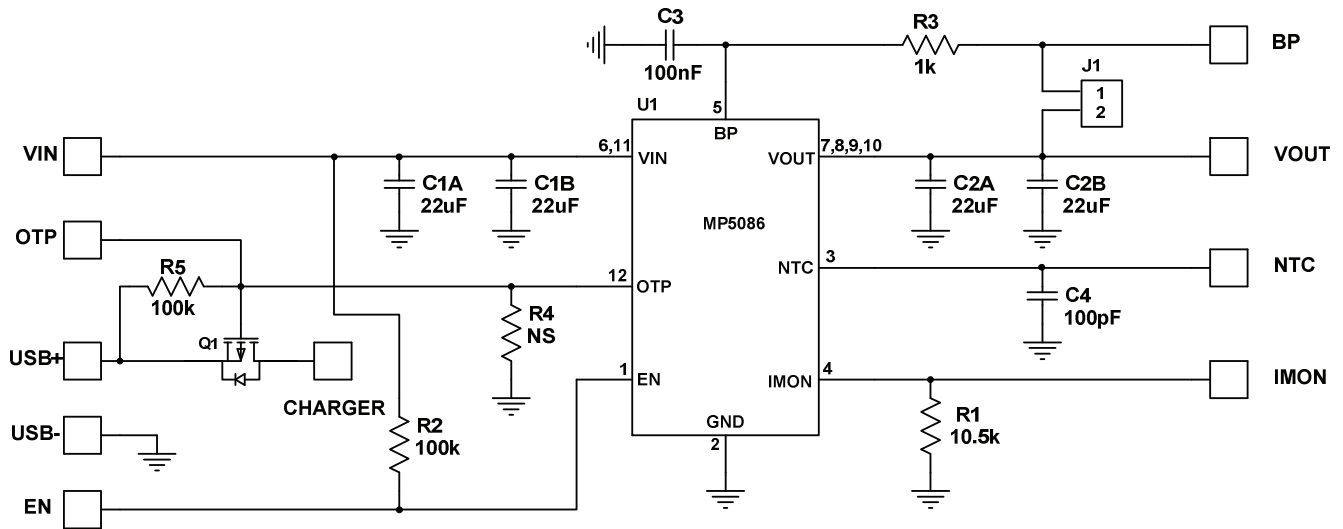

EV5086 BILL OF MATERIALS

Qty	Ref	Value	Description	Package	Manufacturer	Part Number
4	C1A, C1B C2A, C2B	22 μ F	Ceramic Cap, 10V, X5R	1206	muRata	GRM31CR61A226ME19L
1	C3	0.1 μ F	Ceramic Cap, 16V, X7R	0603	muRata	GRM188R71C104KA01D
1	C4	100pF	Ceramic Cap, 50V, C0G	0603	muRata	GRM1885C1H101JA01D
1	R1	10.5k	Film Res, 1%	0603	ROYAL	RL0603FR-0710K5L
2	R2, R5	100k	Film Res, 1%	0603	ROYAL	RL0603FR-07100KL
1	R3	1k	Film Res, 1%	0603	ROYAL	RL0603FR-071KL
0	R4	NS				
1	Q1			SO-8		AM4407P
1	U1		7A Load Switch	QFN 2x2	MPS	MP5086

EVB TEST RESULTS

Performance waveforms are tested on the evaluation board.

$V_{IN} = 3.7V$, OTP Connect to 5V with 100k resistor, $T_A = 25^\circ C$, unless otherwise noted.

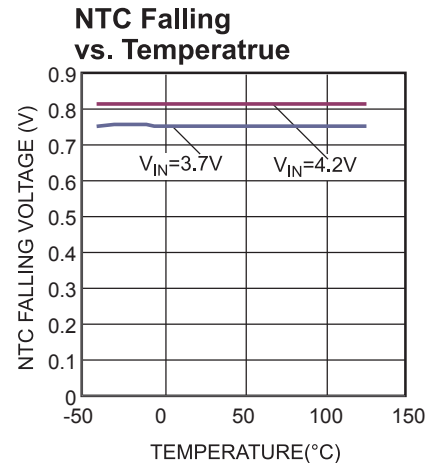
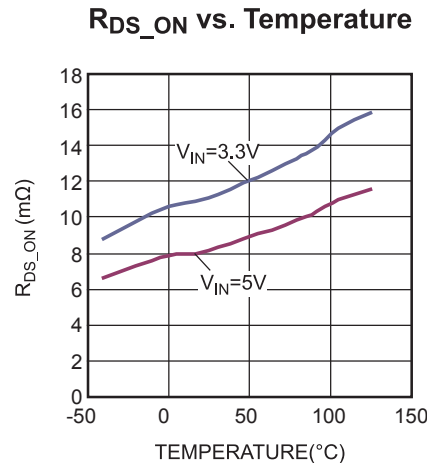
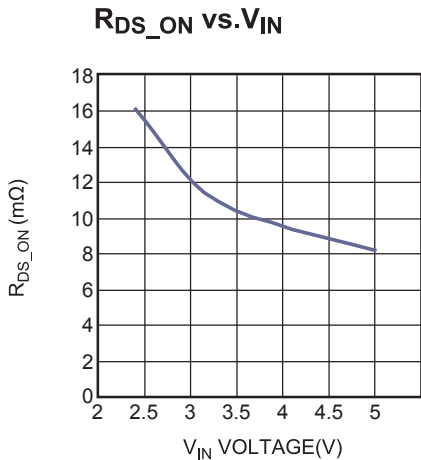
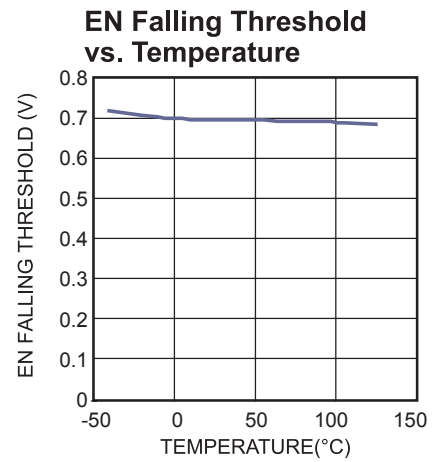
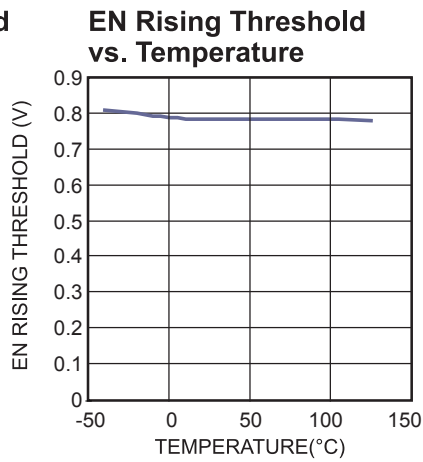
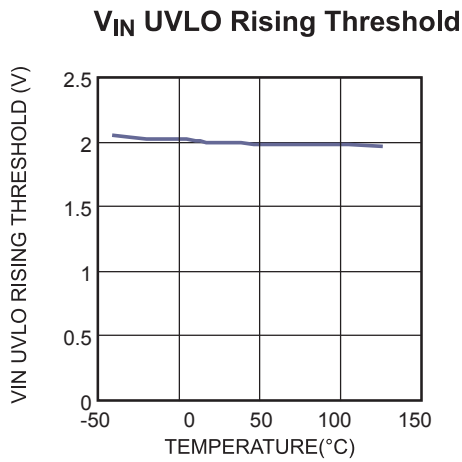
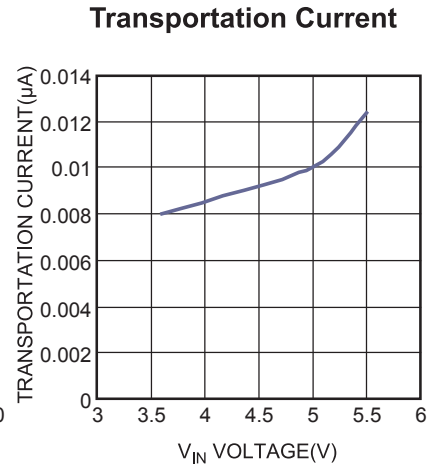
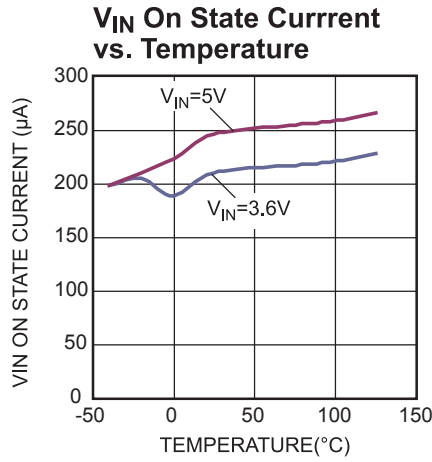
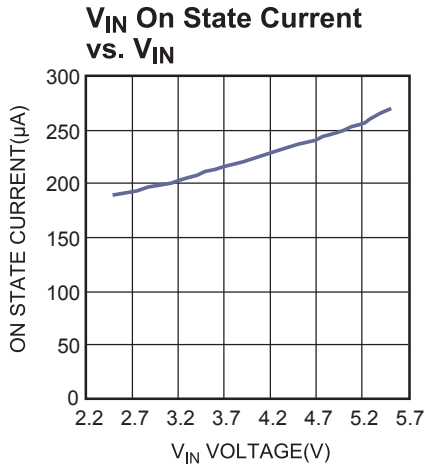

EVB TEST RESULTS *(continued)*

Performance waveforms are tested on the evaluation board.

$V_{IN} = 3.7V$, OTP Connect to 5V with 100k resistor, $T_A = 25^\circ C$, unless otherwise noted.

Current Limit vs. R_{LIMIT}

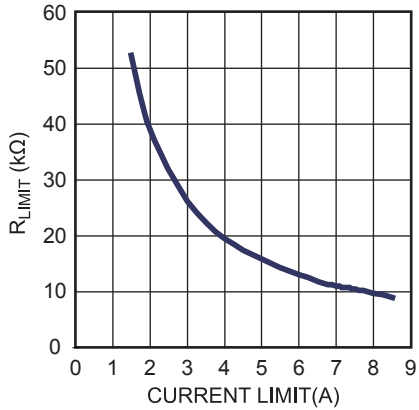

Case Temperature Rise vs. Output Current

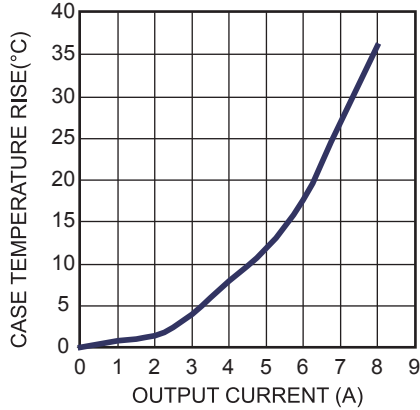

I_{MON} Accuracy vs. I_{OUT}
 $V_{IN}=5V, EN=5V$

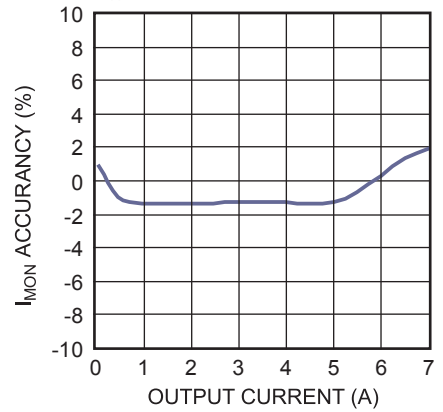

Sense Ratio vs. Temperature

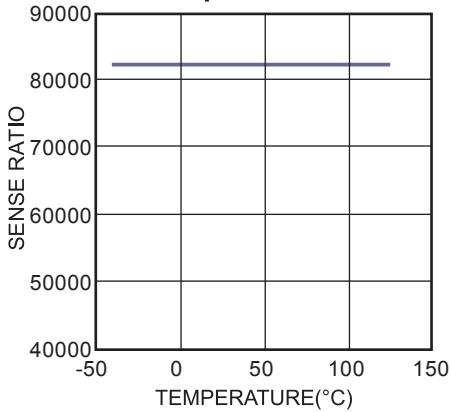

EVB TEST RESULTS *(continued)*

Performance waveforms are tested on the evaluation board.

$V_{IN} = 3.7V$, OTP Connect to 5V with 100k resistor, $T_A = 25^\circ C$, BP pin floated, NTC Connect to Vout, unless otherwise noted.

Steady State

$I_{OUT} = 5A$

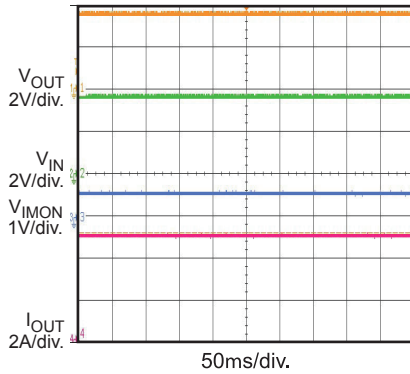

Steady State

$I_{OUT} = 0A$

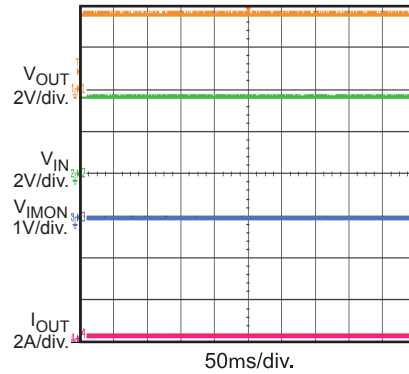

VIN Startup

$I_{OUT} = 5A$

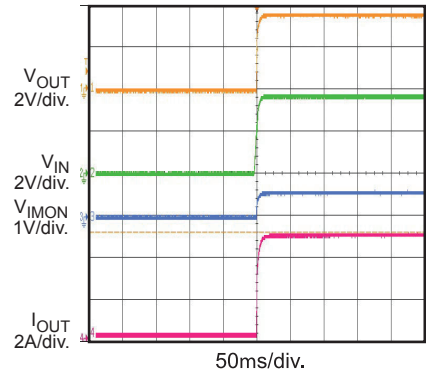

VIN Shutdown

$I_{OUT} = 5A$

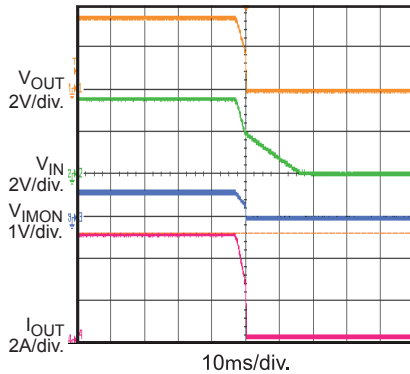

Steady State

$I_{OUT} = 0A$

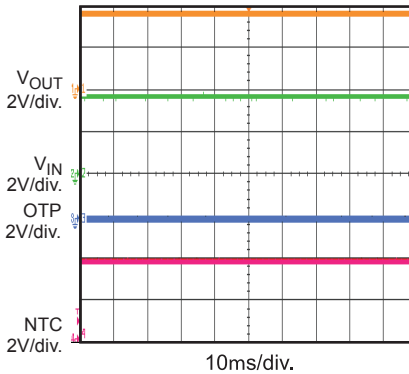

VIN Startup

$I_{OUT} = 0A$

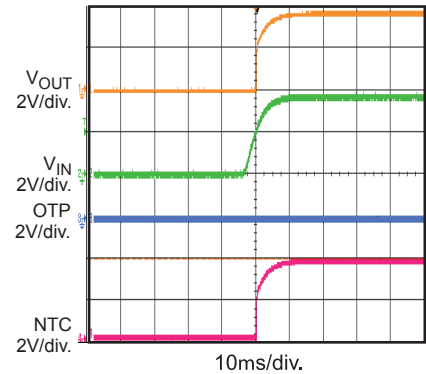

VIN Shutdown

$I_{OUT} = 0A$

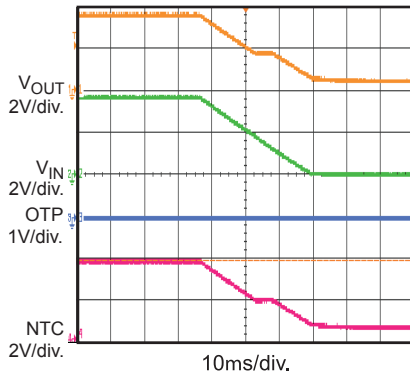

EN Startup

$I_{OUT} = 0A$

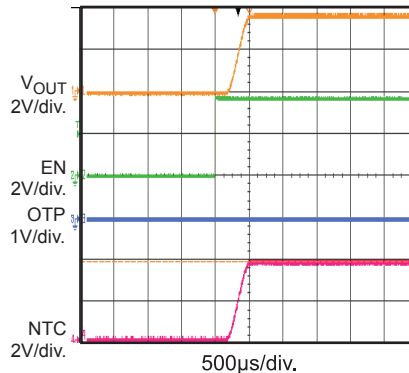

EN Shutdown

$I_{OUT} = 0A$

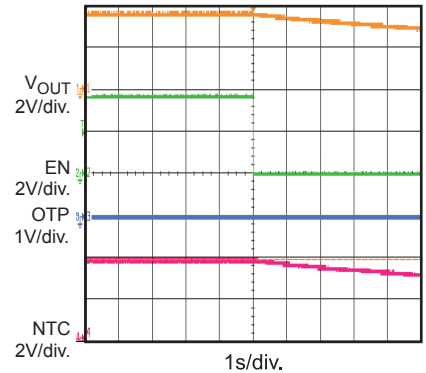

EVB TEST RESULTS *(continued)*

Performance waveforms are tested on the evaluation board.

$V_{IN} = 3.7V$, OTP Connect to 5V with 100k resistor, $T_A = 25^\circ C$, BP pin floated, NTC Connect to Vout, unless otherwise noted.

V_{IN} Startup

$I_{OUT} = 5A$

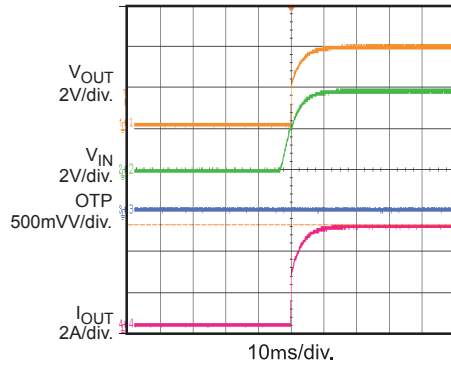

V_{IN} Shutdown

$I_{OUT} = 5A$

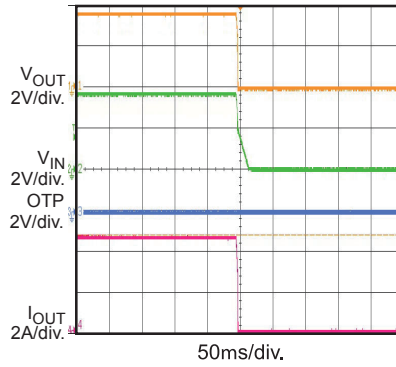

EN Startup

$EN = V_{IN}$, $I_{OUT} = 5A$,

BP connect to V_{OUT}

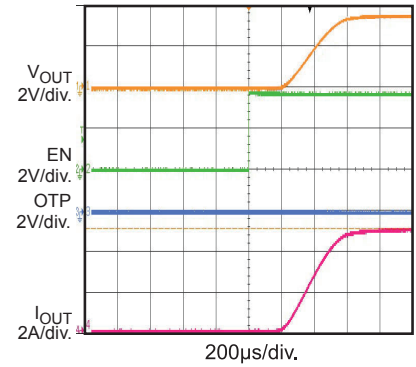

EN Shutdown

$EN = V_{IN}$, $I_{OUT} = 5A$,

BP connect to V_{OUT}

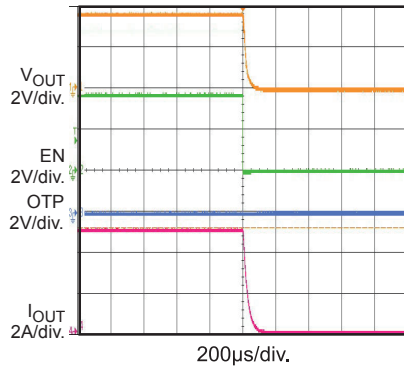

Short Entry

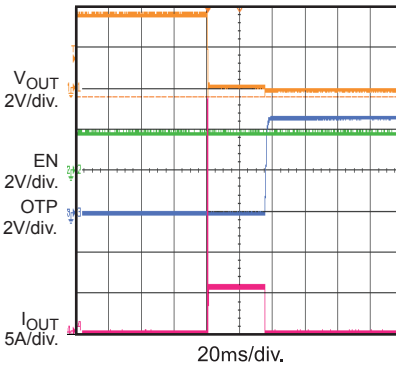

NTC Falling

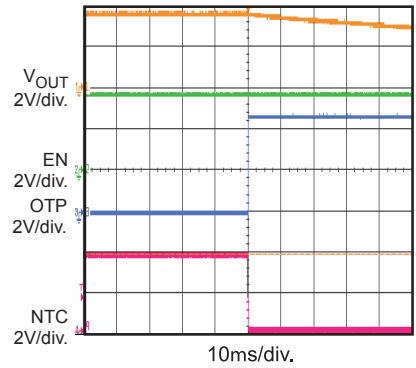

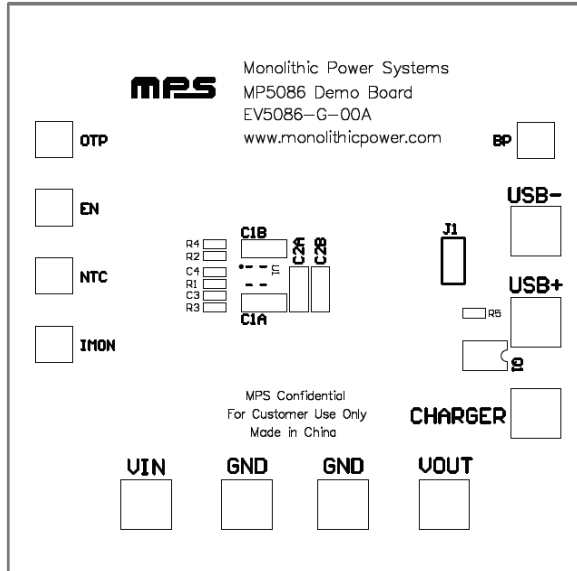

Figure1: Top Layer Silkscreen

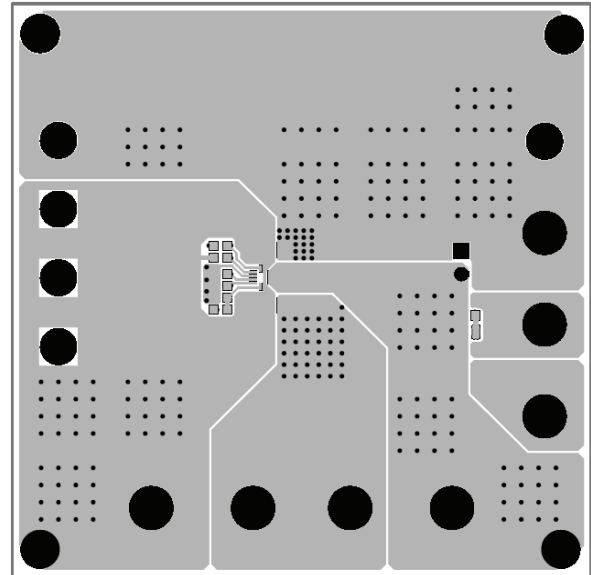

Figure2: Top Layer

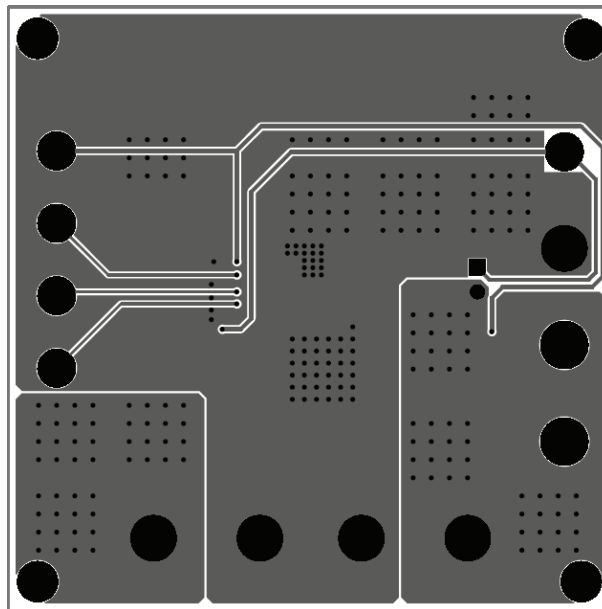

Figure3: Bottom Layer

QUICK START GUIDE

1. Connect the positive and negative terminals of the load to the VOUT and GND pins, respectively.
2. Preset the power supply output between 2.3V and 5.5V, and then turn off the power supply.
3. Connect the positive and negative terminals of the power supply output to the VIN and GND pins, respectively.
4. Connect the NTC pin to external thermistor sensor. If not to use NTC function, just connect to VOUT directly.
5. Turn the power supply on. The MP5086 will automatically startup.
6. To use the bypass mode function, use the J1 to connect the bypass MOS to the VOUT, apply a digital input to the EN pin. Drive EN low to enable the bypass mode.
7. Use R1 to set the output current limit. Follow the Application Information section in the device datasheet to select appropriate R1.

NOTICE: The information in this document is subject to change without notice. Please contact MPS for current specifications. Users should warrant and guarantee that third party Intellectual Property rights are not infringed upon when integrating MPS products into any application. MPS will not assume any legal responsibility for any said applications.