

### DESCRIPTION

The EV5077-G-00A is an evaluation board for the MP5077, a low  $R_{DS(ON)}$  load switch with current limit.

The MP5077 provides up to 7.5A load protection over a 0.5V to 5.5V voltage range. With the small  $R_{DS(ON)}$  in tiny package, MP5077 is a very high efficiency and space saving solution for notebooks, tablets, and other portable/battery-operated applications.

The max load at the output (source) is current limited. This is accomplished by utilizing a sense FET topology. The magnitude of the current limit is controlled by an external resistor from the ILIM pin to ground.

The EV board can deliver a continuous 7A load current over 0.5V-to-5.5V operating input range.

### ELECTRICAL SPECIFICATIONS

Parameter	Symbol	Value	Units
Input Voltage	$V_{IN}$	0.5-5.5	V
Output Voltage	$V_{CC}$	3-5.5	V
Output Current	$I_{OUT}$	7	A

### FEATURES

- Integrated 10m $\Omega$  Low  $R_{DS(ON)}$  FETs
- Adjustable Start Up Slew Rate
- Wide  $V_{IN}$  Range from 0.5V to 5.5V
- <1 $\mu$ A Shutdown Current
- Programmable 7.5A Current Limit Range
- Output Discharge Function
- Enable Pin
- <200ns Short-Circuit Protection Response Time
- Thermal Protection
- Small 2mmx2mm QFN Package for Space Saving

### APPLICATIONS

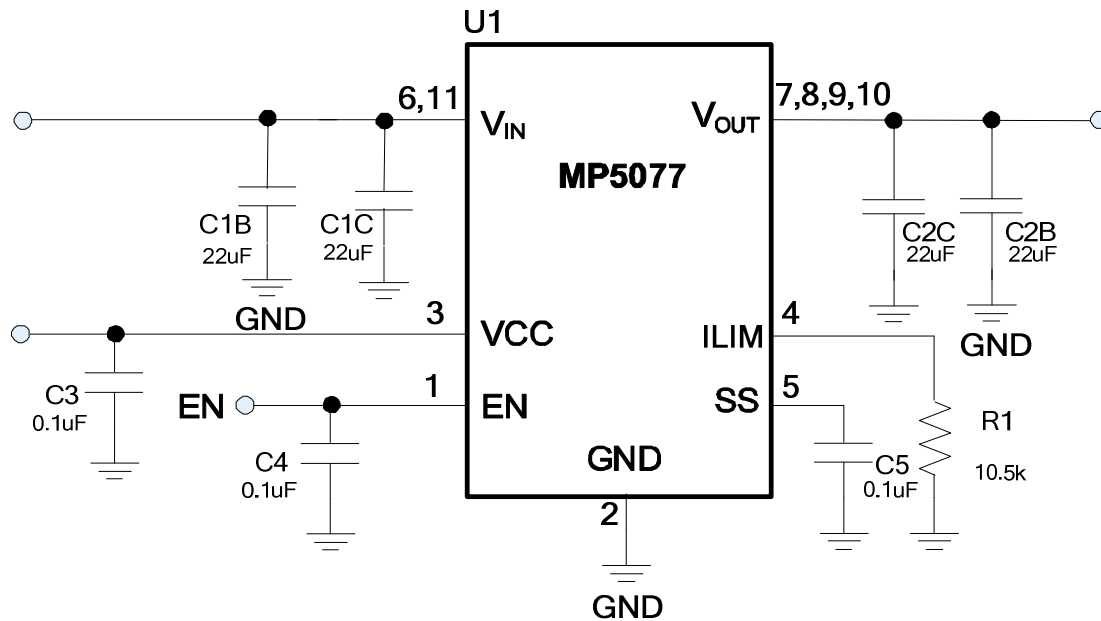
- Notebook and Tablet Computers
- Portable Devices
- Solid State Drives
- Handheld Devices

All MPS parts are lead-free and adhere to the RoHS directive. For MPS green status, please visit MPS website under Products, Quality Assurance page. "MPS" and "The Future of Analog IC Technology" are registered trademarks of Monolithic Power Systems, Inc.

### TYPICAL APPLICATION



## EVALUATION BOARD SCHEMATIC



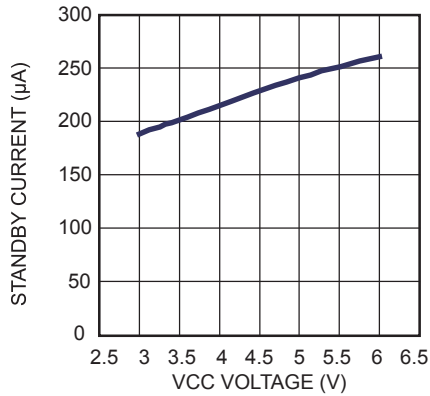
## EV5077 BILL OF MATERIALS

Qty	Ref	Value	Description	Package	Manufacturer	Part Number
4	C1B, C1C C2B, C2C	22µF	Ceramic Cap, 10V, X5R	1206	muRata	GRM31CR61A226ME19L
3	C3, C4, C5	0.1µF	Ceramic Cap, 16V, X7R	0603	muRata	GRM188R71C104KA01D
1	R1	10.5k	Film Res, 1%	0603	ROYAL	RL0603FR-0710K5L
1	U1		7A Load Switch	QFN 2x2	MPS	MP5077

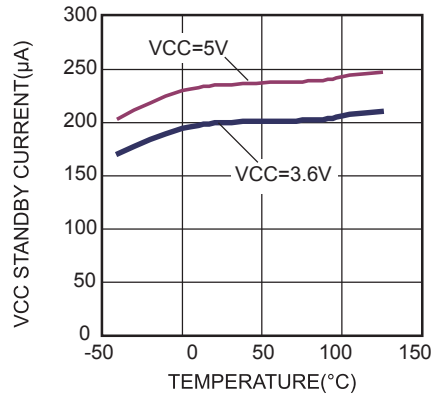
## TYPICAL PERFORMANCE CHARACTERISTICS

$V_{IN} = 3.6V$ ,  $V_{CC} = 3.6V$ ,  $EN=2.5V$ ,  $R_{LIM} = 10.5k$ ,  $T_A = 25^\circ C$ , unless otherwise noted.

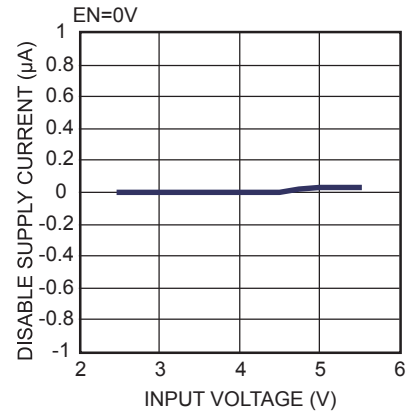
**Vcc Standby Current vs. Vcc**



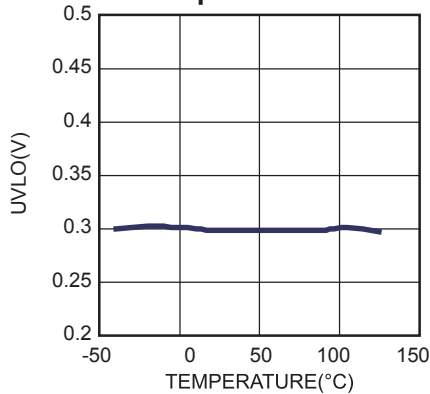
**Vcc Standby Current vs. Temperature**



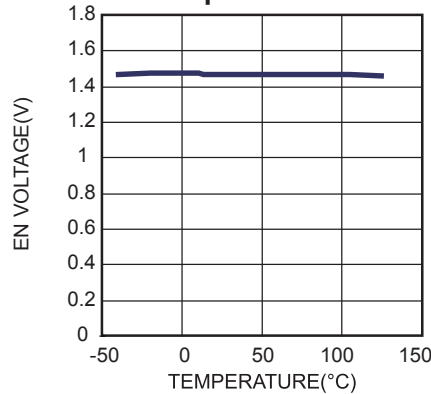
**Disabled Supply Current vs. Input Voltage**



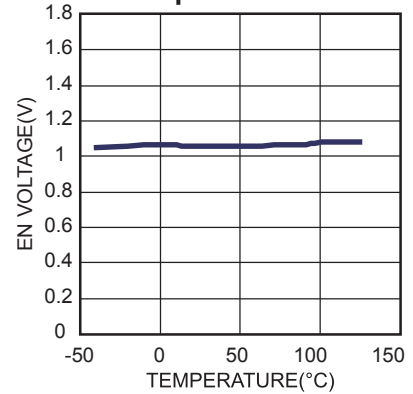
**VIN UVLO Rising Threshold vs. Temperature**



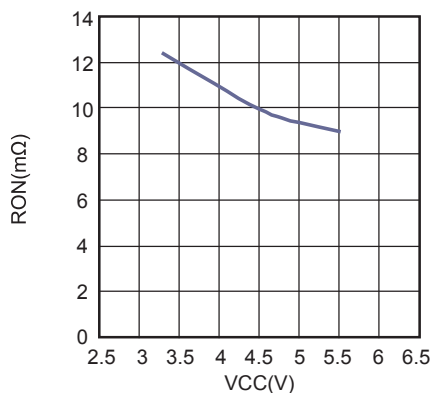
**EN Rising Threshold vs. Temperature**



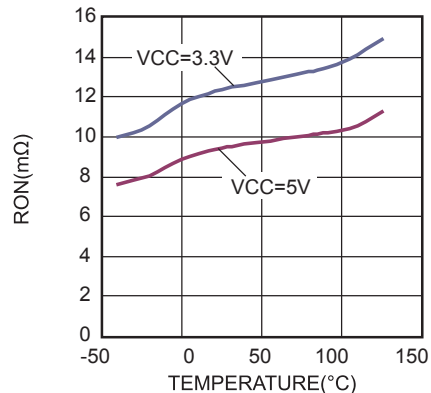
**EN Falling Threshold vs. Temperature**



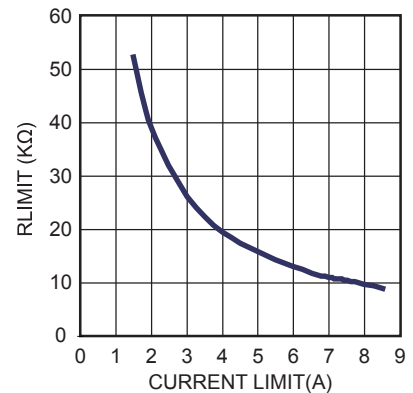
**Rds\_on vs. Vcc**



**Rds\_on vs. Temperature**



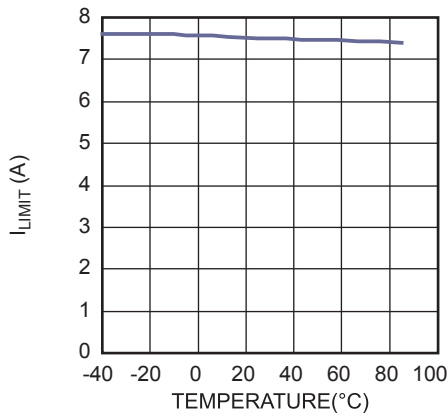
**Current Limit vs Rlimit**



**TYPICAL PERFORMANCE CHARACTERISTICS (continued)**

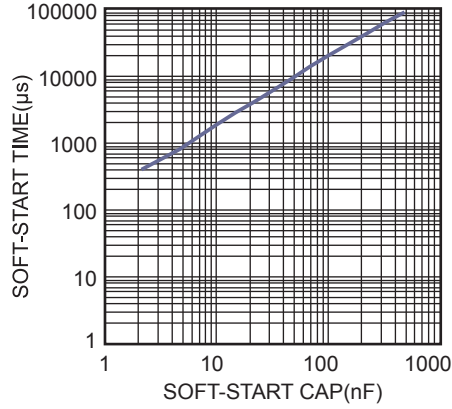
$V_{IN} = 3.6V$ ,  $V_{CC} = 3.6V$ ,  $EN=2.5V$ ,  $R_{LIM} = 10.5k$ ,  $T_A = 25^\circ C$ , unless otherwise noted.

**I<sub>LIMIT</sub> vs. Temperature**

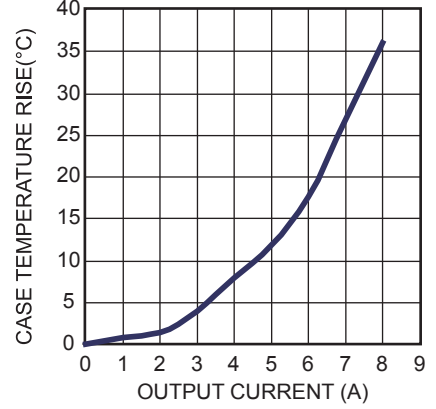


**Soft-Start vs.Cap**

$V_{IN}=5V$ ,  $V_{CC}=3.6V$



**Case Temperature Rise vs. Output Current**

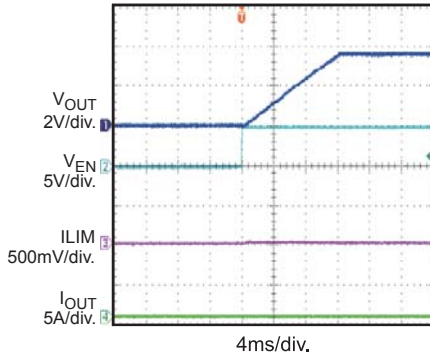


**TYPICAL PERFORMANCE CHARACTERISTICS (continued)**

$V_{IN} = 3.6V$ ,  $V_{CC} = 3.6V$ ,  $EN=2.5V$ ,  $R_{LIM} = 10.5k$ ,  $T_A = 25^\circ C$ , unless otherwise noted.

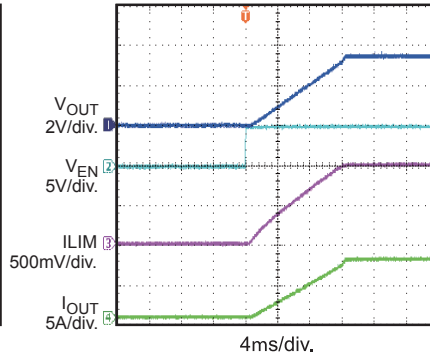
**Enable Startup**

$V_{IN} = 3.6V$ ,  $V_{CC} = 3.6V$ , No Load



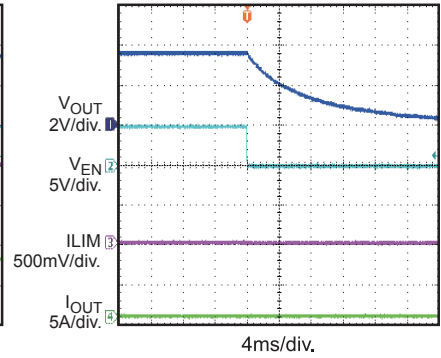
**Enable Startup**

$V_{IN} = 3.6V$ ,  $V_{CC} = 3.6V$ , 7A Load



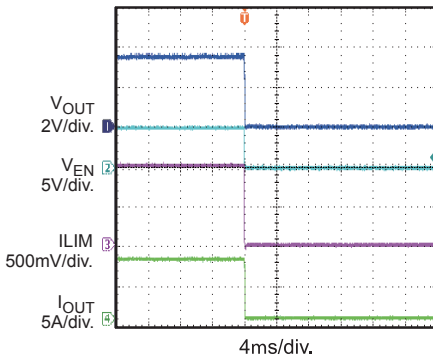
**Enable Shutdown**

$V_{IN} = 3.6V$ ,  $V_{CC} = 3.6V$ , No Load



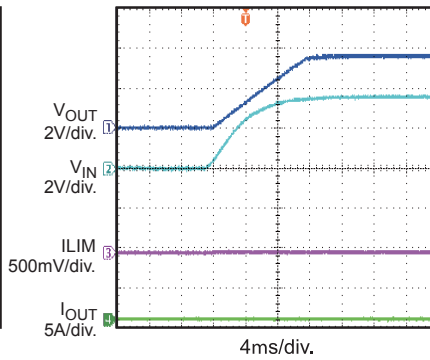
**Enable Shutdown**

$V_{IN} = 3.6V$ ,  $V_{CC} = 3.6V$ , 7A Load



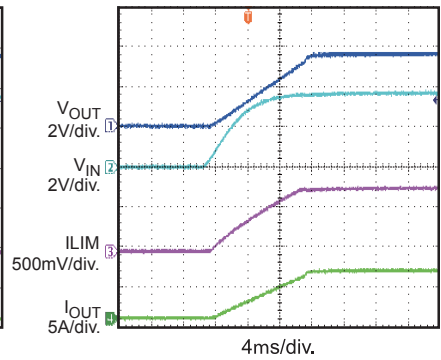
**Power Up**

$V_{IN} = 3.6V$ ,  $V_{CC} = 3.6V$ , No Load



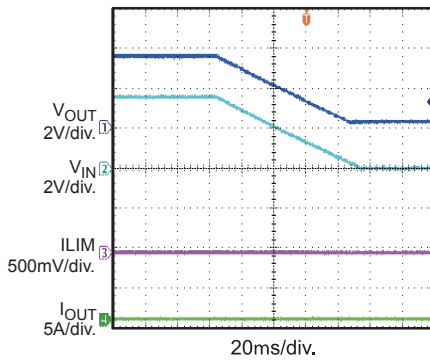
**Power Up**

$V_{IN} = 3.6V$ ,  $V_{CC} = 3.6V$ , 7A Load



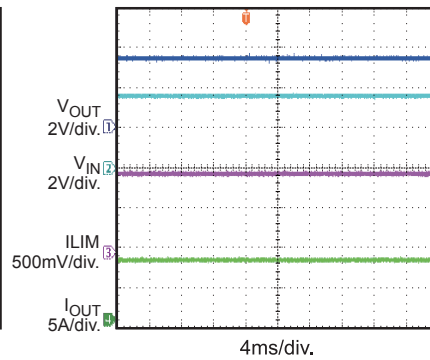
**Power Down**

$V_{IN} = 3.6V$ ,  $V_{CC} = 3.6V$ , No Load



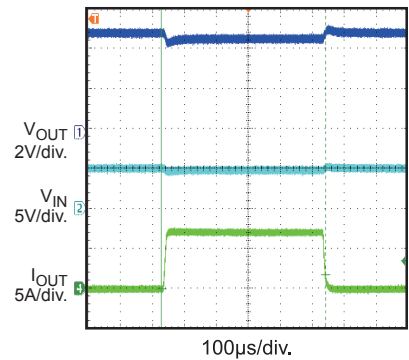
**Steady State**

$V_{IN} = 3.6V$ ,  $V_{CC} = 3.6V$ , 7A Load



**Load Transient Response**

$V_{IN} = 5V$ ,  $V_{CC} = 3.3V$ ,  $I_{OUT} = 0A-7A$

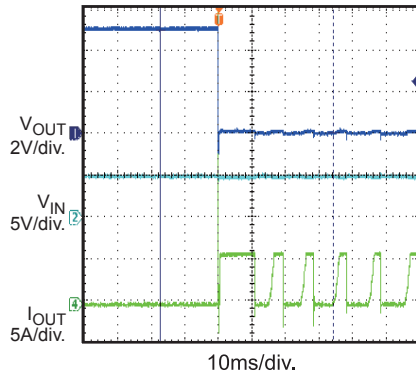


## TYPICAL PERFORMANCE CHARACTERISTICS *(continued)*

$V_{IN} = 3.6V$ ,  $V_{CC} = 3.6V$ ,  $EN=2.5V$ ,  $R_{LIM} = 10.5k$ ,  $T_A = 25^\circ C$ , unless otherwise noted.

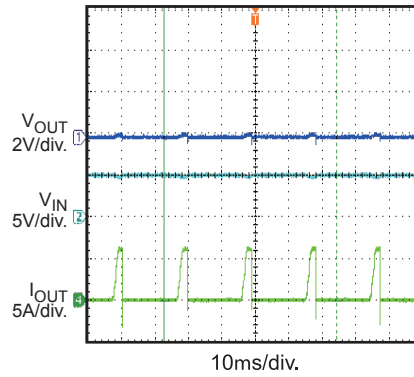
### SCP Enter

$V_{IN} = 5V$ ,  $V_{CC} = 3.3V$ ,  $R_{LIM} = 10.5k$



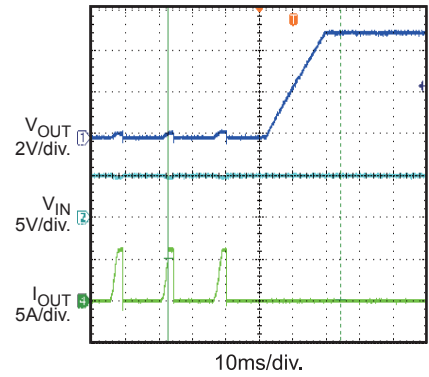
### SCP Steady State

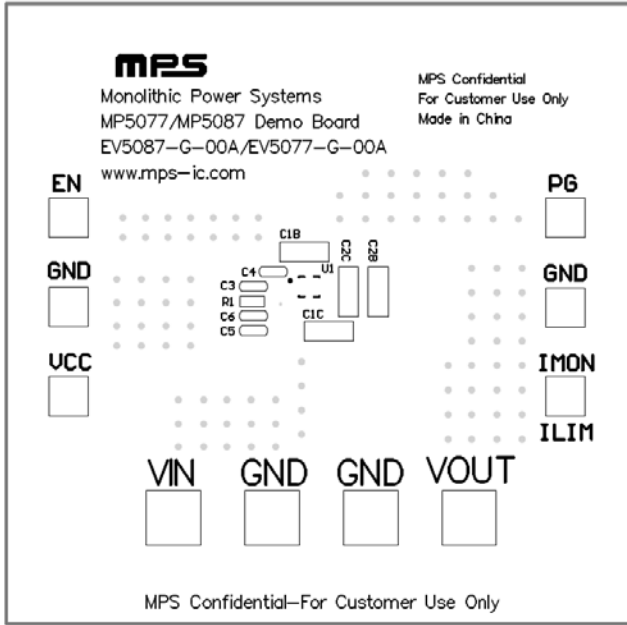
$V_{IN} = 5V$ ,  $V_{CC} = 3.3V$ ,  $R_{LIM} = 10.5k$



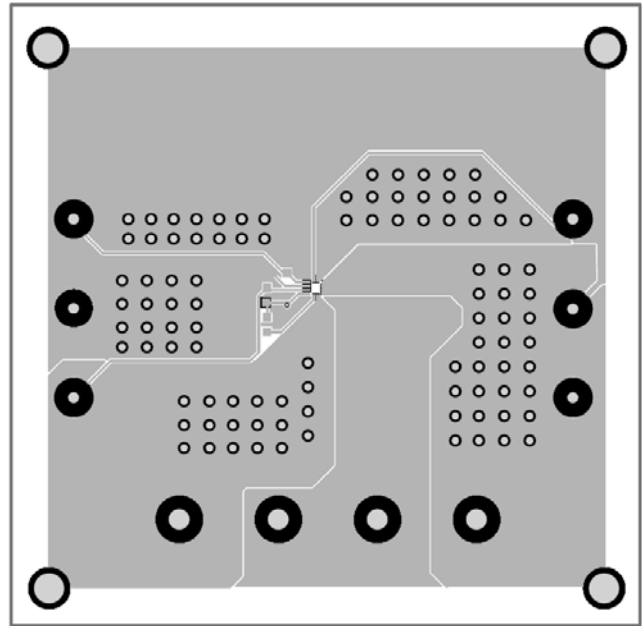
### SCP Recover

$V_{IN} = 5V$ ,  $V_{CC} = 3.3V$ ,  $R_{LIM} = 10.5k$

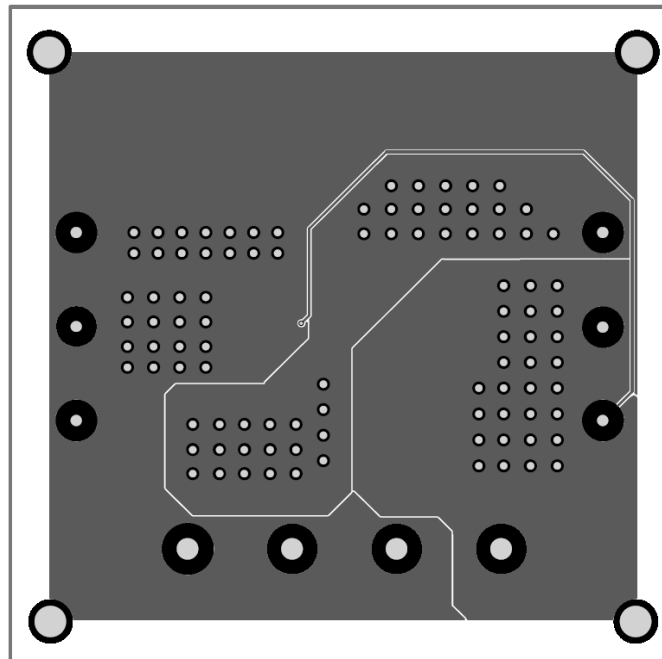




**Figure1: Top Layer Silkscreen**



**Figure2: Top Layer**



**Figure3: Bottom Layer**

## QUICK START GUIDE

1. Connect the positive and negative terminals of the load to the VOUT and GND pins, respectively.
2. Preset the power supply output between 0.5V and 5.5V, and then turn off the power supply.
3. Connect the positive and negative terminals of the power supply output to the VIN and GND pins, respectively.
4. Follow the step 1-3 to set the Vcc voltage between 3V and 5.5V.
5. Turn the power supply on. The MP5077 will automatically startup.
6. To use the Enable function, apply a digital input to the EN pin. Drive EN higher than 2.6V to turn on the regulator or less than 0.4V to turn it off.
7. Use R1 to set the output current limit. C5 to set the SS time, Follow the Application Information section in the device datasheet to select appropriate R1, C5.

**NOTICE:** The information in this document is subject to change without notice. Please contact MPS for current specifications. Users should warrant and guarantee that third party Intellectual Property rights are not infringed upon when integrating MPS products into any application. MPS will not assume any legal responsibility for any said applications.