

DESCRIPTION

The EV4581 Evaluation Board is designed to demonstrate the capabilities of MPS' MP4581.

The MP4581 is a high efficiency synchronous step-down converter with integrated high-side and low-side MOSFETs. It provides 0.8A output in buck topology from up to 100V input power supply.

MP4581 supports high efficiency pulse-skip-mode (PSM) in light load condition. Valley current limit circuits protect against overload and short circuit conditions.

The MP4581 is available in a SOIC8EP packages.

ELECTRICAL SPECIFICATION

Parameter	Symbol	Value	Units
Input Voltage	V _{IN}	10 - 100	V
Output Voltage	V _{OUT}	5	V
Output Current	I _{OUT}	0 - 0.8	A

FEATURES

- 10V-to-100V Input Voltage Range
- 1V-to-30V Output Voltage Range
- 90% Maximum Operation Duty Cycle
- 625mΩ / 380mΩ Internal MOSFETs
- Constant On Time Control Mode
- Programmable 100kHz to 1MHz Frequency
- Internal Soft-Start and Loop Compensation
- OCP, SCP with Hiccup
- High Efficiency PSM in Light Load
- Available in SOIC8EP Package

APPLICATIONS

- High Voltage Battery Packs
- Industrial Power Supplies
- Printer Power Board

All MPS parts are lead-free, halogen-free, and adhere to the RoHS directive. For MPS green status, please visit the MPS website under Quality Assurance. "MPS" and "The Future of Analog IC Technology" are registered trademarks of Monolithic Power Systems, Inc.

EV4581-N-00A EVALUATION BOARD

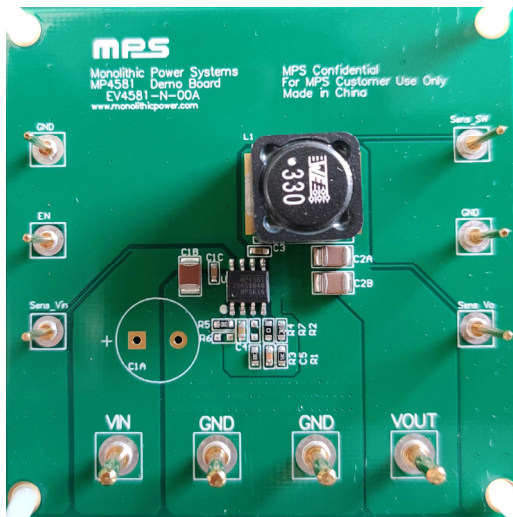

(L × W × H) 6.35cm x 6.35cm x 0.6cm

Board Number	MPS IC Number
EV4581-N-00A	MP4581GN

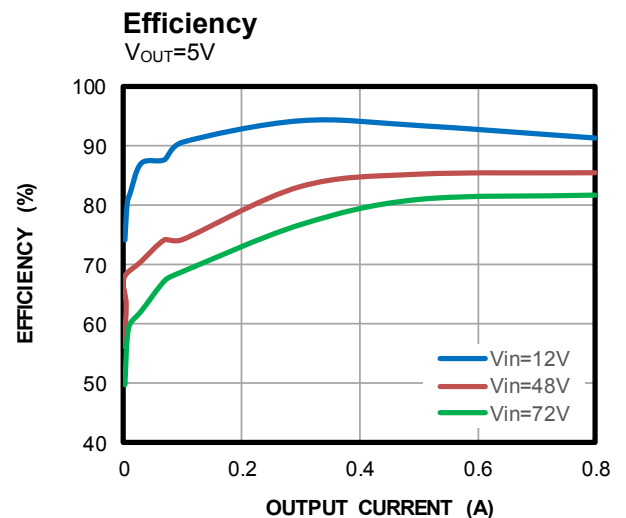

EVALUATION BOARD SCHEMATIC

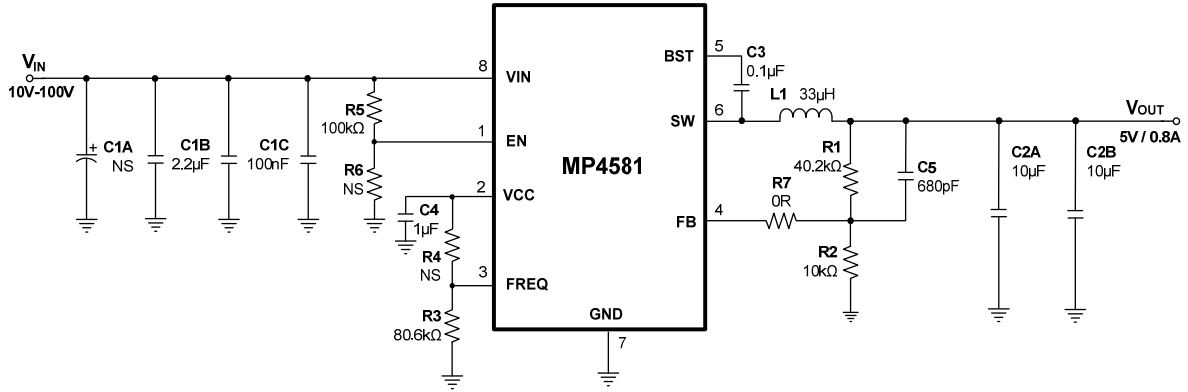

EV4581-N-00A BILL OF MATERIALS

Qty	Ref	Value	Description	Package	Manufacturer	Manufacturer PN
1	C1B	2.2 μ F	Ceramic Cap, 100V, X7R	1210	muRata	GRM32ER72A225KA88L
2	C1C, C3	100nF	Ceramic Cap, 100V, X7R	0603	muRata	GRM188R72A104KA01D
2	C2A, C2B	10 μ F	Ceramic Cap, 25V, X7R	1210	muRata	GRM32DR71E106KA12L
1	C4	1 μ F	Ceramic Cap, 16V, X7R	0603	muRata	GRM188R71C105KA01D
1	C5	680pF	Ceramic Cap, 50V, COG	0603	muRata	GRM1885C1H681JA01D
1	R1	40.2K	Film resistor, 1%	0603	YAGEO	RC0603FR-0740K2L
1	R2	10K	Film resistor, 1%	0603	YAGEO	RC0603FR-0710KL
1	R3	80.6K	Film resistor, 1%	0603	YAGEO	RC0603FR-0780K6L
1	R5	100K	Film resistor, 1%	0603	YAGEO	RC0603FR-07100KL
1	R7	0R	Film resistor, 1%	0603	YAGEO	RC0603FR-070RL
0	C1A, R4, R6	NS				
1	L1	33 μ H	Isat=4.2A, 45m Ω inductor	SMD	Wurth	7447709330
1	U1	MP4581	100V, 0.8A Synchronous Buck	SOIC8EP	MPS	MP4581GN

EVB TEST RESULTS

Performance curves and waveforms are tested on the evaluation board.

$V_{IN} = 48V$, $V_{OUT} = 5V$, $L = 33\mu H$, $T_A = 25^\circ C$, unless otherwise noted.

Efficiency vs. I_o

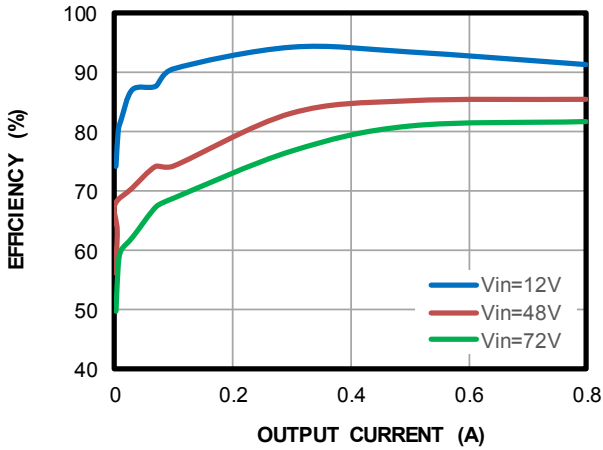

Load Regulation

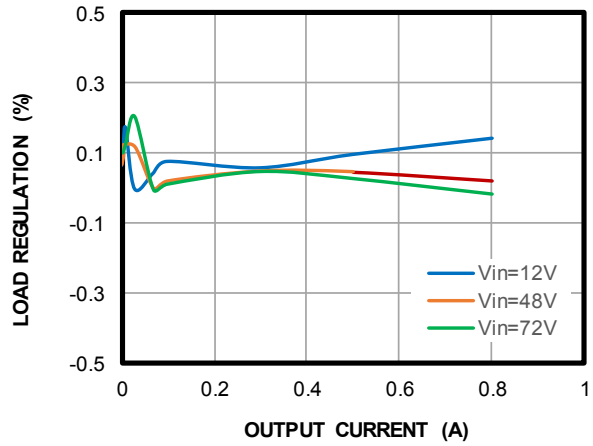

Line Regulation

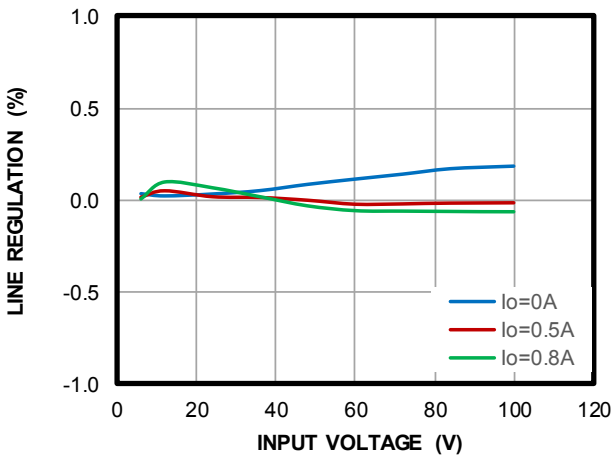

Bode Plot

$I_{OUT} = 0.8A$

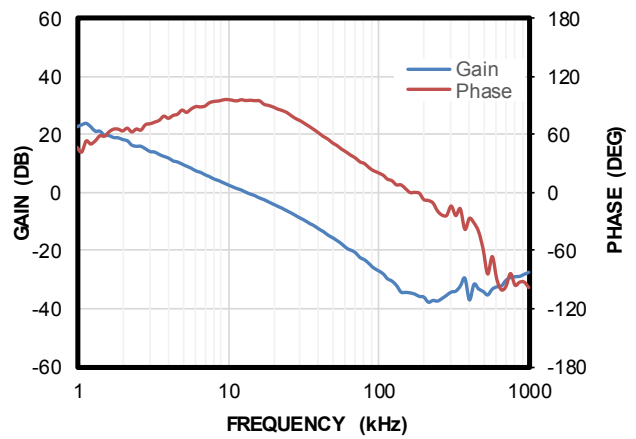

Case Temperature Rise. vs. Output Current

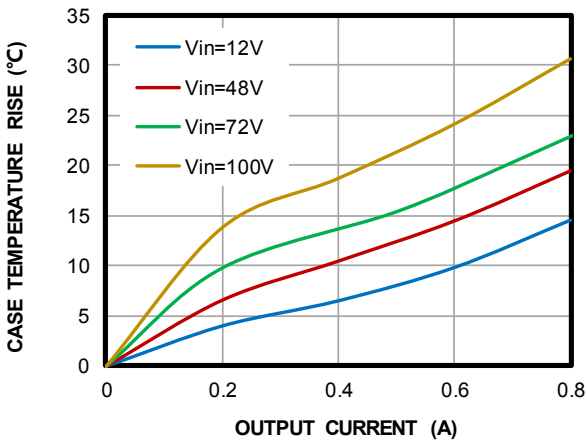

EVB TEST RESULTS (continued)

Performance curves and waveforms are tested on the evaluation board.

$V_{IN} = 48V$, $V_{OUT} = 5V$, $L = 33\mu H$, $T_A = 25^{\circ}C$, unless otherwise noted.

Steady State

$I_{OUT}=0A$

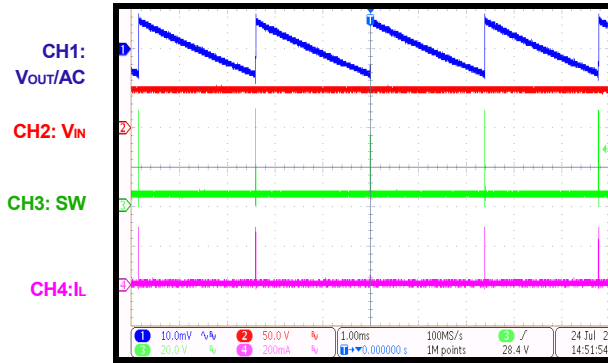

Steady State

$I_{OUT}=0.4A$

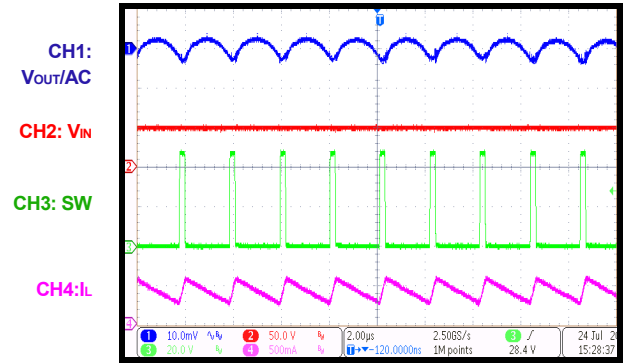

Steady State

$I_{OUT}=0.8A$

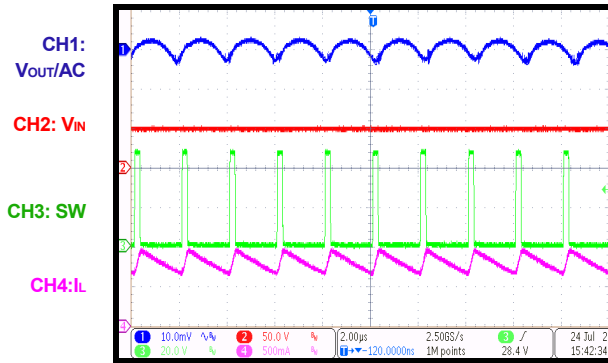

VIN Start-Up

$I_{OUT}=0A$

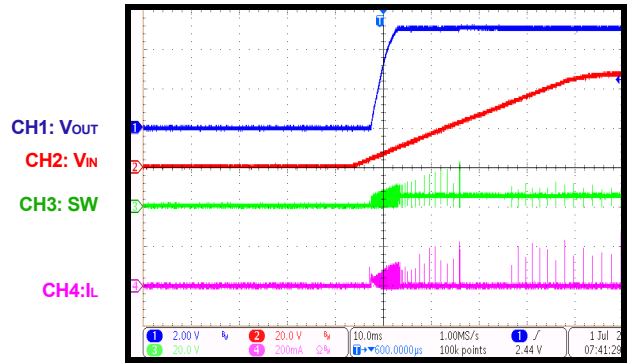

VIN Start-Up

$I_{OUT}=0.8A$

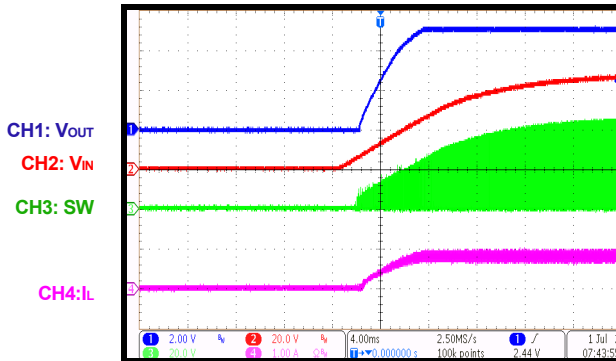

VIN Shutdown

$I_{OUT}=0A$

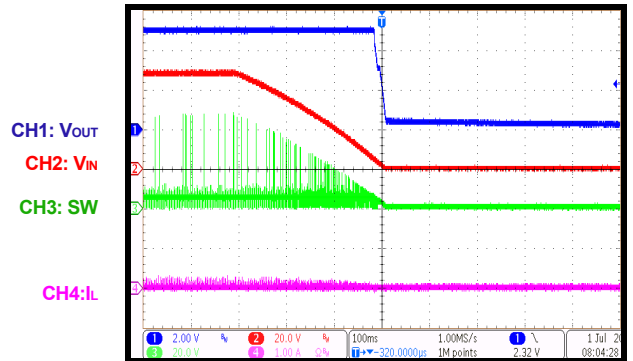

EVB TEST RESULTS (continued)

Performance curves and waveforms are tested on the evaluation board.

$V_{IN} = 48V$, $V_{OUT} = 5V$, $L = 33\mu H$, $T_A = 25^\circ C$, unless otherwise noted.

VIN Shutdown

$I_{OUT} = 0.8A$

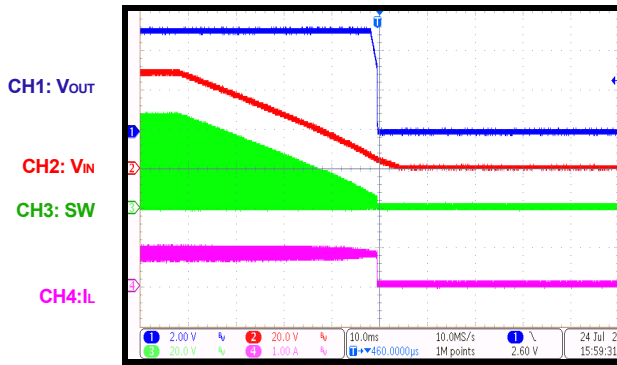

EN ON

$I_{OUT} = 0A$

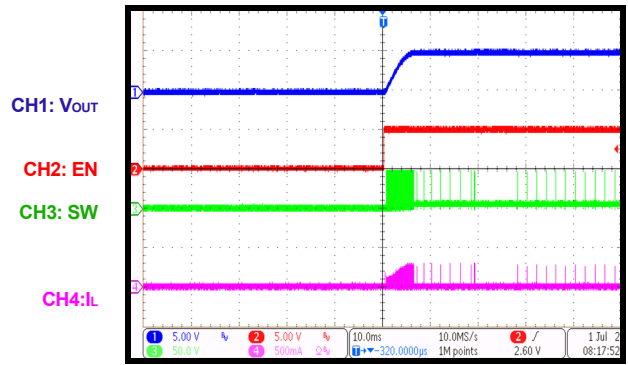

EN ON

$I_{OUT} = 0.8A$

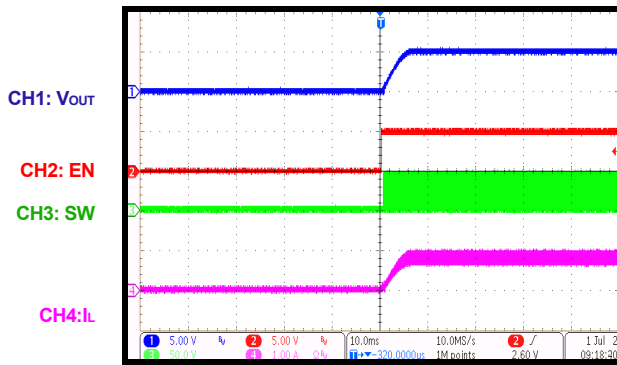

EN OFF

$I_{OUT} = 0A$

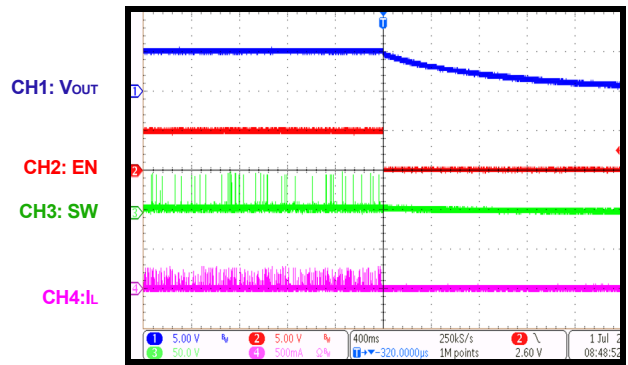

EN OFF

$I_{OUT} = 0.8A$

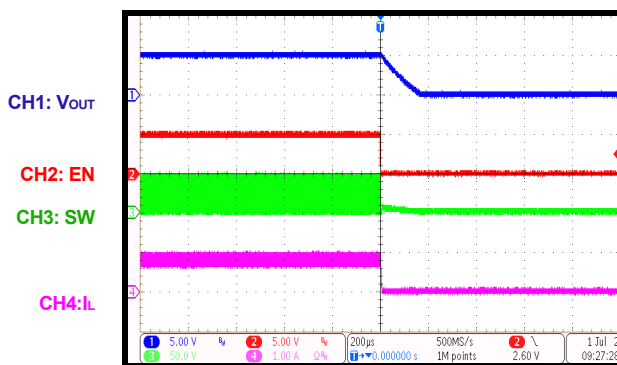

Load Transient

$I_{OUT} = 0A$ to $0.4A$

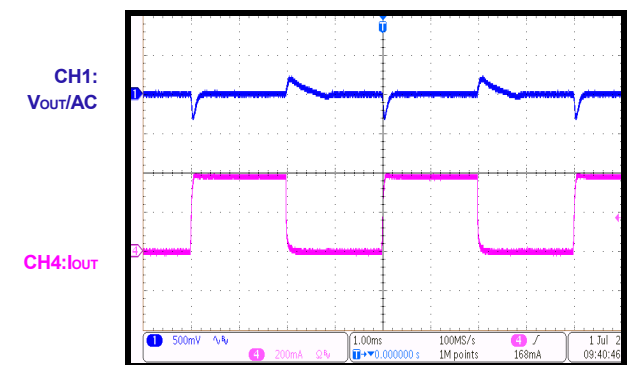

EVB TEST RESULTS (continued)

Performance curves and waveforms are tested on the evaluation board.

$V_{IN} = 48V$, $V_{OUT} = 5V$, $L = 33\mu H$, $T_A = 25^\circ C$, unless otherwise noted.

Load Transient

$I_{OUT} = 0.4A$ to $0.8A$

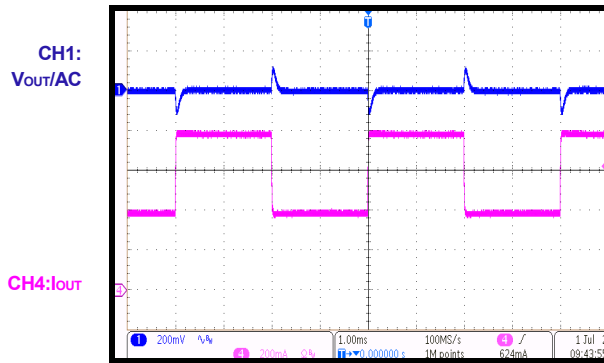

SCP Entry

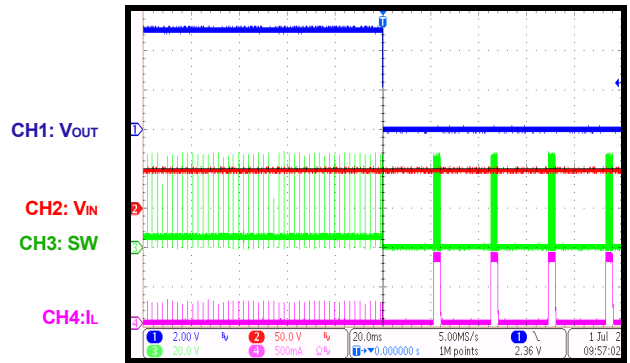

SCP Steady State

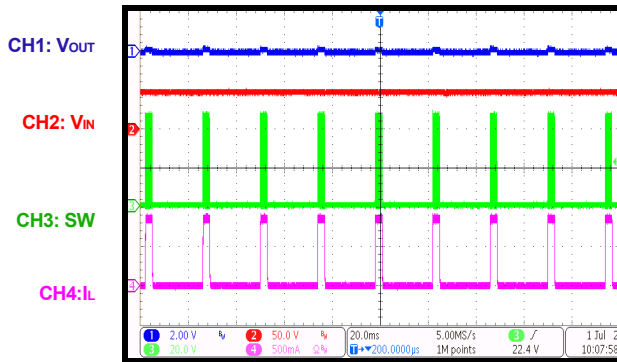

SCP Recovery

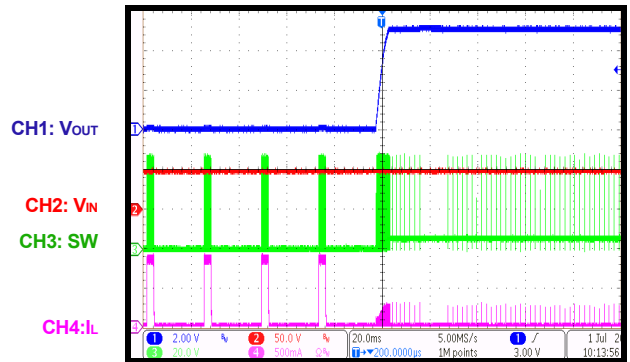

PRINTED CIRCUIT BOARD LAYOUT

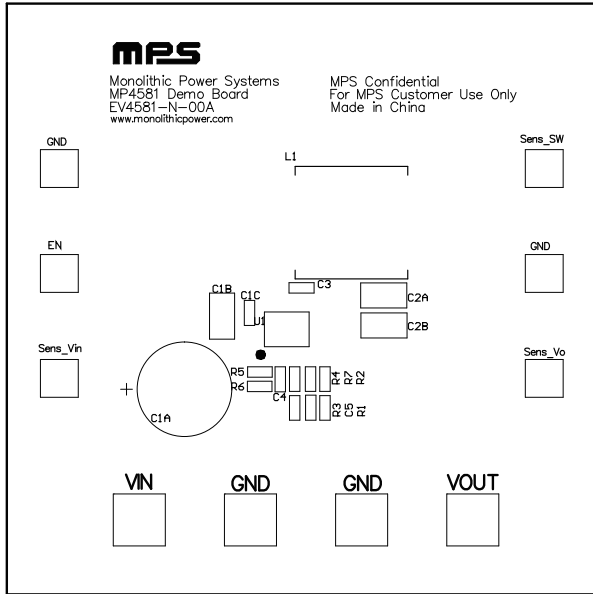

Figure 1: Top Silkscreen Layer

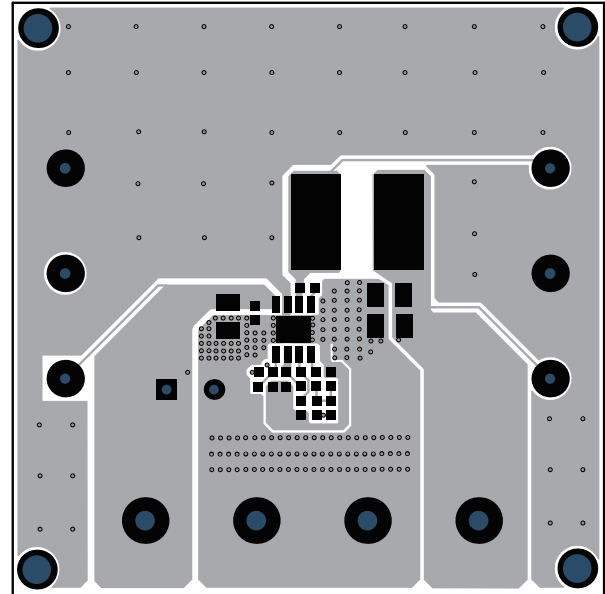

Figure 2: Top Layer

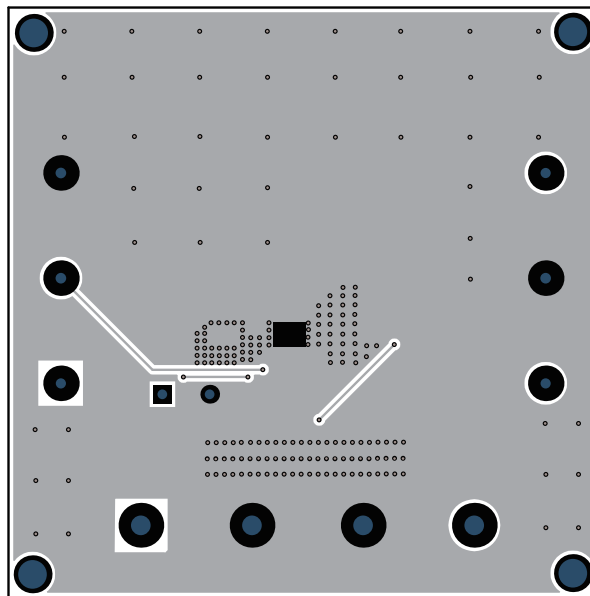

Figure 3: Bottom Layer

QUICK START GUIDE

The output voltage of this board is set to 5V. The board layout accommodates most commonly used components. Following below steps to quick start EV4581-N-00A.

1. Preset Power Supply to $10V \leq V_{IN} \leq 100V$.
2. Turn Power Supply off.
3. Connect Power Supply terminals to:
 - a. Positive (+): VIN
 - b. Negative (-): GND
4. Connect Load to:
 - a. Positive (+): VOUT
 - b. Negative (-): GND
5. Turn Power Supply on after making connections.
6. The MP4581 is enabled on the evaluation board once VIN is applied.
7. The output voltage VOUT can be changed by varying R1 and R2. Calculate the new value using the formula:

$$V_{OUT} = V_{FB} \times \left(1 + \frac{R1}{R2}\right)$$

Where VFB = 1V.

8. To use the Enable function, apply a digital input to the EN pin. Drive EN higher than 1.35V to turn on EV4581-N-00A or less than 0.4V to turn it off.

NOTICE: The information in this document is subject to change without notice. Please contact MPS for current specifications. Users should warrant and guarantee that third party Intellectual Property rights are not infringed upon when integrating MPS products into any application. MPS will not assume any legal responsibility for any said applications.