

DESCRIPTION

The EV4088-S-00A Evaluation Board is designed to demonstrate the capabilities of MP4088. The MP4088 is a highly integrated TRIAC dimmable LED driver with high power factor. It is specifically designed for high-line input (230VAC), no-isolated, TRIAC-dimmable LED lighting applications, especially for the low cost and small form factor applications.

The MP4088 integrates a 500V MOSFET. Only a single winding inductor is required to realize the solution. It features MPS's proprietary hybrid operation mode which is designed to achieve good dimming performance.

The EV4088-S-00A is typically designed for driving a 5.5W TRIAC dimmable LED bulb with 55V_{TYP}, 100mA LED load from 198VAC to 265VAC, 50Hz.

The EV4088-S-00A has an excellent efficiency and meets IEC61547 surge immunity, IEC61000-3-2 Class C harmonics and EN55015 conducted EMI requirements. It has multi-protection function as over-voltage protection; output short-circuit protection, thermal shut down, etc.

ELECTRICAL SPECIFICATION

Parameter	Symbol	Value	Units
Input Voltage	V _{IN}	198 to 265	VAC
Output Voltage	V _{OUT}	55	V
LED Current	I _{LED}	100	mA
Output Power	P _{OUT}	5.5	W
Efficiency (full load)	η	>76	%
Power Factor	PF	>0.80	
THD	THD	<50.3	%

FEATURES

- Excellent TRIAC Dimming Performance
- Lowest Cost BOM
- Constant Current LED Driver
- Good LED Current Accuracy
- 500V MOSFET Integrated
- Internal HV Fast Start-Up
- Single Winding Inductor
- High Power Factor(>0.80)
- LED Current Foldback at High Temperature
- Thermal Shutdown (Auto Restart with Hysteresis)
- VCC Under Voltage Lockout with Hysteresis (UVLO)
- Programmable Over Voltage Protection
- Output Short Circuit Protection
- Fit inside GU10 Bulb Enclosure

APPLICATIONS

- Solid State Lighting
- Industrial & Commercial Lighting
- Residential Lighting

All MPS parts are lead-free and adhere to the RoHS directive. For MPS green status, please visit MPS website under Quality Assurance. "MPS" and "The Future of Analog IC Technology", are Registered Trademarks of Monolithic Power Systems, Inc.



Warning: Although this board is designed to satisfy safety requirements, the engineering prototype has not been agency approved. Therefore, all testing should be performed using an isolation transformer to provide the AC input to the prototype board.

EV4088-S-00A EVALUATION BOARD

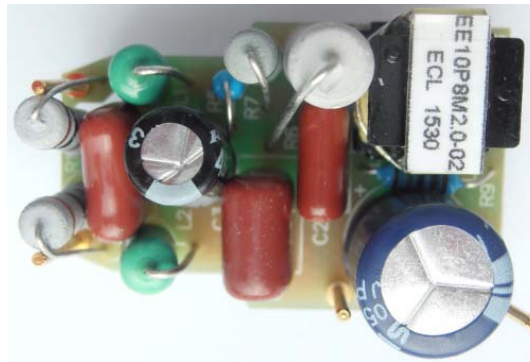
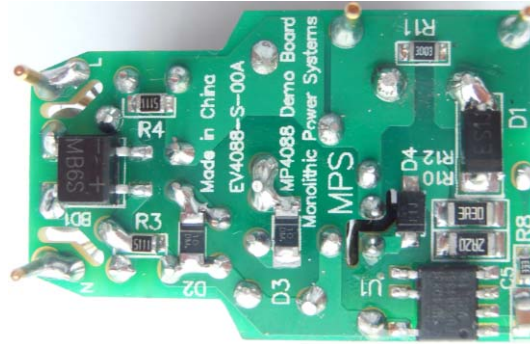

(L x W x H) 35mm x 22.5mm x 20mm

Board Number	MPS IC Number
EV4088-S-00A	MP4088GS

EVALUATION BOARD SCHEMATIC

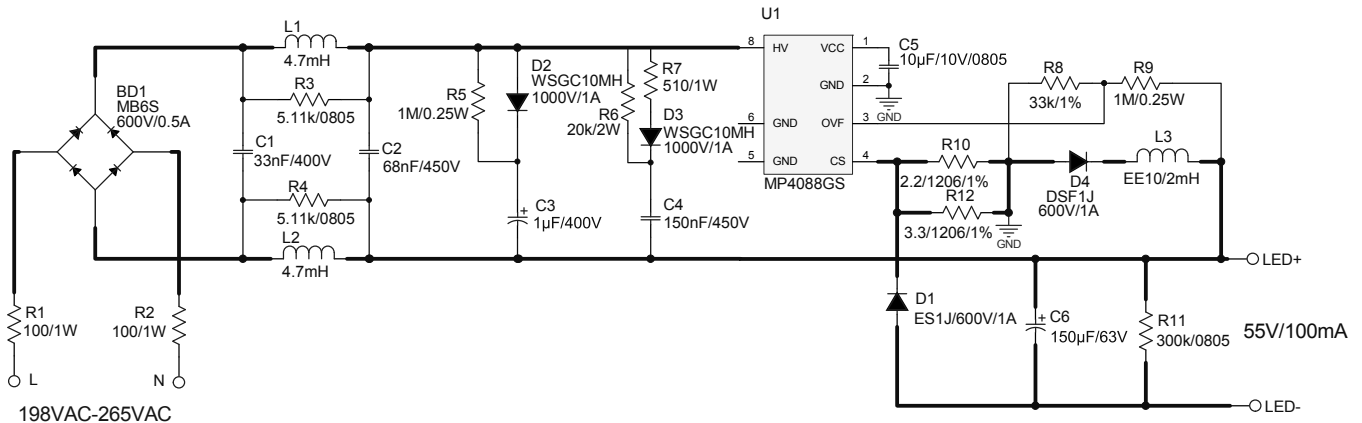

Figure 1—Schematic

PCB LAYOUT (SINGLE-SIDED)

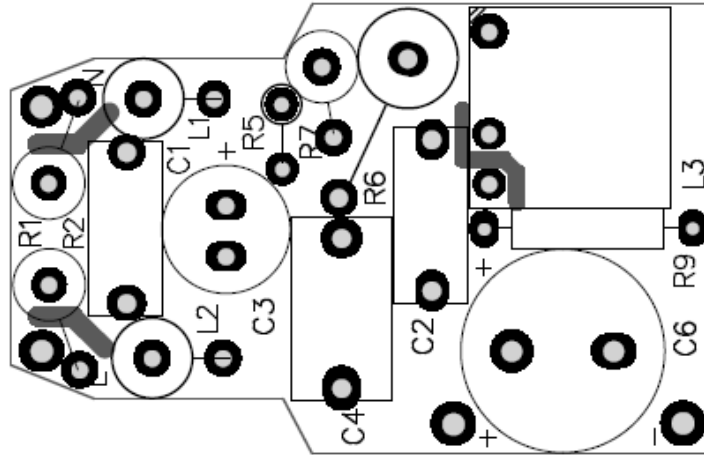

Figure 2—Top Layer

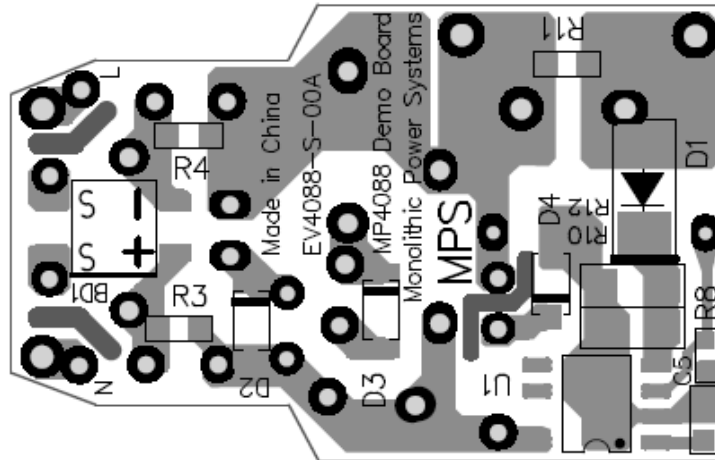

Figure 3—Bottom Layer

CIRCUIT DESCRIPTION

The EV4088-S-00A is configured in a single-stage Buck-boost topology and gets a cost effective BOM. It also achieves high power factor and excellent TRIAC dimming performance.

R1, R2, and BD1 compose the input stage. The resistors R1, R2 are used as a passive damper of dimming. The diode rectifier BD1 rectifies the input line voltage.

L1, L2, R3, R4, C1 and C2 form a π EMI filter.

R5, C3, and D2 form a RCD snubber to obtain good surge test performance, the surge spike energy will be absorbed by the electrolytic cap C3.

R7, C4 are used as a bleeder which keeping the TRIAC current above the minimum holding current after leading edge dimmer turns on. The D3, R6 are used to reduce the big capacitance influence after trailing edge dimmer turns off and improve the trailing edge dimming.

C5 is used to supply the power for MP4088. The power is charged by the internal high voltage regulator from HV pin.

R8 and R9 are used to monitor the output OVP condition. The OVP voltage is set by the divider ratio of R8 and R9.

R10, R12 are sensing resistors for LED current control. The value of R10 and R12 set the output LED current.

Diode D1 is the Buck-boost fly-wheel diode, the inductor L3 and the capacitor C6 are the output filter. The resistor R11 is placed as a dummy load to consume the output power in open load condition. The diode D4 is used to prevent the output current flowing back to IC when input Sine voltage drops lower than output voltage.

EV4088-S-00A BILL OF MATERIALS

Qty	Ref	Value	Description	Package	Manufacturer	Manufacture_P/N
1	BD1	MB6S	Rectifier Bridge, 600V,0.5A	SOIC-4	Taiwan Semiconductor	MB6S
1	C1	33nF/400V	Capacitor,400V,CBB	DIP	Ponasonic	ECQE400VDC333K
1	C2	68nF/450V	Capacitor,450V,CBB	DIP	Fala	C222S683J30C000
1	C3	1 μ F/400V	Electrolytic Capacitor, 400V	DIP	Rubycon	400LLE1MEFC6.3X11
1	C4	150nF/450V	Capacitor,450V,CBB	DIP	Fala	C222S154K30C000
1	C5	10 μ F/10V	Ceramic Capacitor, 10V,X7R	0805	Murata	GRM21BR71A106ME51L
1	C6	150 μ F/63V	Electrolytic Capacitor, 63V	DIP	YMIN	LK 150uF/63V
1	D1	ES1J	Diode,1A,600V	SMA	TOSHIBA	ES1J
2	D2,D3	WSGC10MH	Diode,1A,1000V	1206	ZOWIE	WSGC10MH
1	D4	DSF1J	Diode,1A,600V	SOD-123	SXY	DSF1J
2	L1,L2	4.7mH	Inductor,4.7mH	DIP	Bangdayuan	CKL0510-472
1	L3	2mH	Inductor, Φ 0.18mm, 277 turns	EE10	Emei	FX0424
2	R1,R2	100 Ω /1W	Resistor,5%,1W	DIP	Any	100Ohm/1W
2	R3,R4	5.11k Ω	Thick Film Chip Res, 1%	0805	Royalohm	0805F5111T5E
2	R5,R9	1M/0.25W	Resistor,0.25W	DIP	Any	1M/0.25W
1	R6	20k Ω /2W	Resistor,5%,2W	DIP	Any	20k Ω /2W
1	R7	510 Ω /1W	Resistor,5%,1W	DIP	Any	510 Ω /1W
1	R8	33k Ω	Film Resistor,1%	0603	Yageo	RC0603FR-0733KL
1	R10	2.2 Ω	Film Resistor,1%	1206	Yageo	RC1206FR-072R2L
1	R11	300k Ω	Film Resistor,1%	0805	Yageo	RC0805FR-07300KL
1	R12	3.3 Ω	Film Resistor,1%	1206	Yageo	RC1206FR-073R3L
1	U1	MP4088GS	Triac-dimmable LED Lighting Controller	SOIC8LD- 7	MPS	MP4088GS R5
4	L,N, +,-	1.0 公针				1.0 公针

TRANSFORMER SPECIFICATION

Electrical Diagram

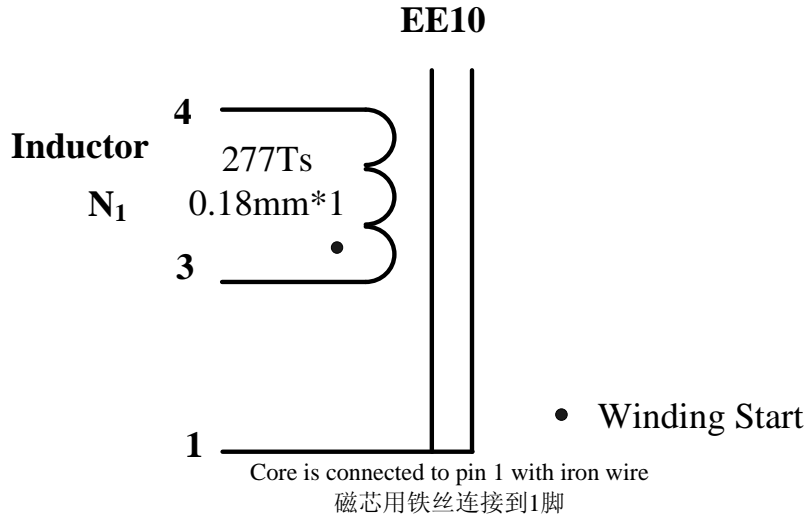

Figure 4—Transformer Electrical Diagram

Winding Diagram

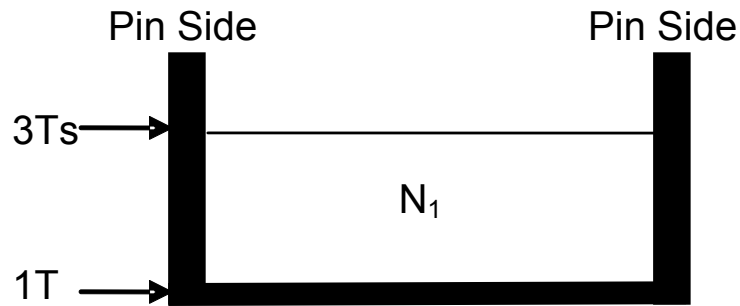

Figure 5—Winding Diagram

Winding Order

胶带圈数 (Tape Layer Number)	绕组顺序 (Winding No.)	始末脚位 (Start & End)	线径 ϕ (Magnet Wire)	圈数 (Turns)
1				
3	N	3 → 4	0.18*1	277
		磁芯(Core) → 1	细铁丝(thin iron wire)	3

Electrical Specifications

Electrical Strength	60 second, 50Hz, from Winding to CORE.	1000VAC
Inductance	Pins 3 - 4, measured at 60kHz, 0.1 VRMS	2mH±8%

Materials

Item	Description
1	Core: EE10, UI=2500±25%, AL=221.5H/N ² ±2% GAP, ACME P4 or equivalent
2	Bobbin: EE10, 4+4PIN RMMOVE PIN 2,5,6,7,8
3	Wire: Φ 0.18mm, 2UEW, CLASS F or equivalent, thin iron wire
4	Tape: 6.5mm(W)×0.06mm(TH)
5	Varnish: JOHN C. DOLPH CO, BC-346A or equivalent
6	Solder Bar: CHEN NAN: SN99.5/Cu0.5 or equivalent

EVB TEST RESULTS

Performance Data

Efficiency, PF and THD

f (Hz)	Vin (V)	Pin (W)	Vo(V)	Io (mA)	Po (W)	Efficiency (%)	PF
50	198	6.89	55.80	96	5.36	77.71	0.886
	210	7.08	55.90	98	5.48	77.38	0.870
	220	7.23	55.90	100	5.59	77.32	0.858
	230	7.38	55.90	102	5.70	77.26	0.847
	240	7.51	55.90	103	5.76	76.67	0.835
	250	7.68	56.00	105	5.88	76.56	0.823
	260	7.78	56.00	106	5.94	76.30	0.813
	265	7.87	56.00	107	5.99	76.14	0.807

Dimming Compatibility (No Flicker with these 25 different Dimmers)

Dimmer NO.	Manufacturer	Part No.	Power Stage	Dimming Type	I _{max} (mA)	I _{min} (mA)
1	MIKA	433/4	60-400W	Leading	91	34
2	Busch	2250U	600W	Leading	97	17
3	Berker	283010	60-400W	Leading	95	23
4	JUNG	225 NV DE	20-500W/VA	Leading	93	13
5	Berker	286610	20-500W	Leading	95	21
6	JUNG	266 GDE	60-600W	Leading	95	19
7	Berker	2875	60-600W	Leading	95	17
8	JUNG	225 NV DE	20-500W/VA	Leading	95	20
9	Berker	2819	60-400W	Leading	92	36
10	MIKA	433	60-300	Leading	91	35
11	GIRA	0300 00/I01	60-400W	Leading	89	40
12	TELLER	40600RL	40-600W	Leading	90	18
13	Busch	2247U	500W/VA	Leading	94	21
14	EMC	PROP400U	40-400W	Leading	91	17
15	Busch	2200..	60-400W	Leading	95	26
16	LICHTREGLER	T46s	20~315W	Trailing	94	31
17	Busch	6513 U-102	420W/VA	Trailing	100	39
18	MIKA	433 HAB	20-315W	Trailing	92	27
19	MIKA?	EIM-585	20-300W	Trailing	89	9
20	Busch	6519U	550W/VA	Trailing	99	38
21	JUNG	225 TDE	20-525W	Trailing	96	29
22	SIEMENS	5TC8 284	20-600W	Trailing	98	36
23	JUNG	254 UDIE 1	50-420W/VA	Trailing	97	37
24	Berker	286110	50-420W	Trailing	97	37
25	MIKA	433HAB	20-315W	Trailing	86	28

Electric Strength Test

Input and output was shorted respectively. 3750VAC/50Hz sine wave applied between input and output for 1min, and operation was verified.

Surge Test

Line to Line 500V surge testing was completed according to IEC61547.

Input voltage was set at 230VAC/50Hz. Output was loaded at full load and operation was verified following each surge event.

Surge Level (V)	Input Voltage (VAC)	Injection Location	Injection Phase (°)	Test Result (Pass/Fail)
500	230	L to N	90	Pass
-500	230	L to N	270	Pass

Thermal Test

Test without dimmer and with dimmer

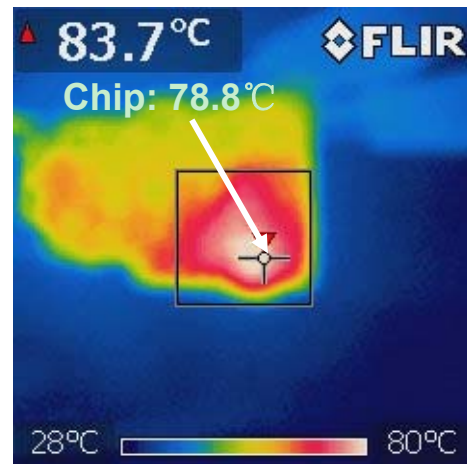
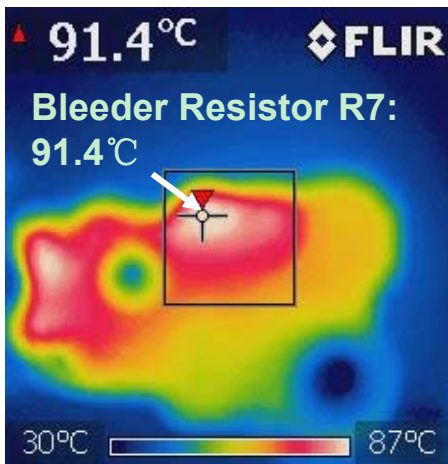
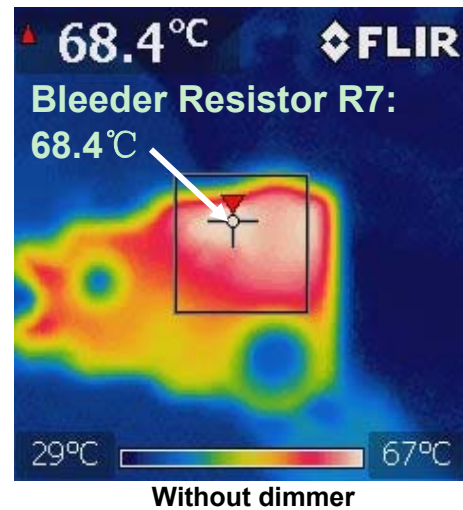
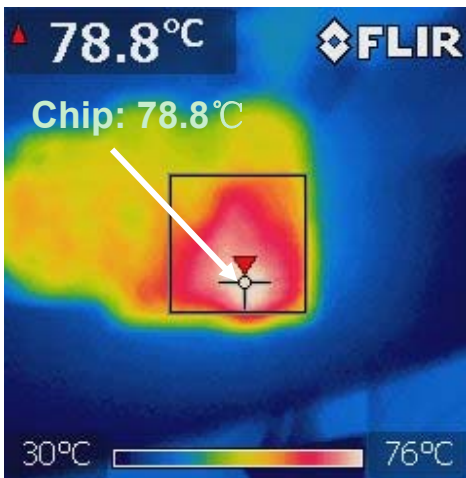

EVB TEST RESULTS

Performance waveforms are tested on the evaluation board.

$V_{IN}=230V_{AC}/50Hz$, 18 LEDs in series, $I_{LED}=100mA$, $V_{OUT}=55V$.

Line Regulation

$V_{IN}=(198-265)V_{AC}/50Hz$, Full Load

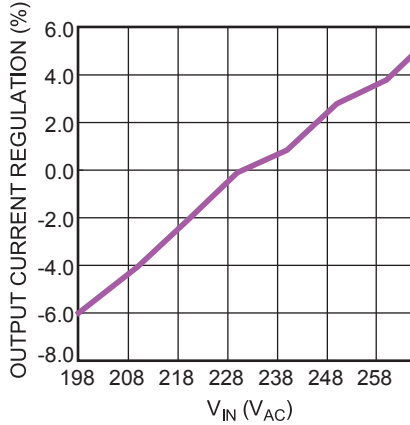

Efficiency vs. V_{IN}

$V_{IN}=(198-265)V_{AC}/50Hz$, Full Load

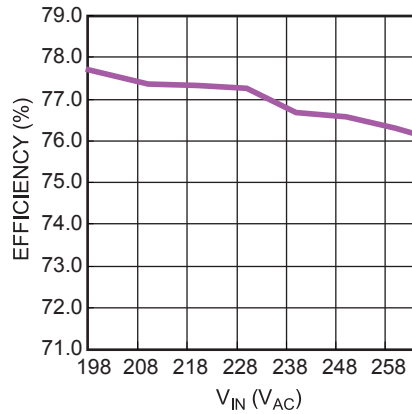

PF vs. V_{IN}

$V_{IN}=(198-265)V_{AC}/50Hz$, Full Load

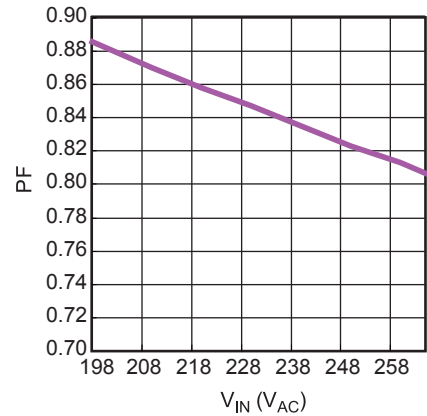

THD vs. V_{IN}

$V_{IN}=(198-265)V_{AC}/50Hz$, Full Load

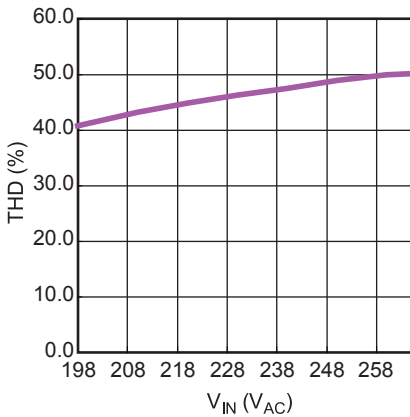

Dimming Curve

$V_{IN}=230V_{AC}/50Hz$, Full Load

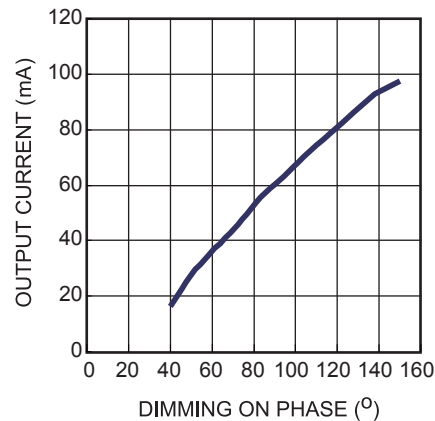

Conducted EMI, L-Line

$V_{IN}=230V_{AC}/50Hz$, Full Load, RBW=9kHz, MT=20ms

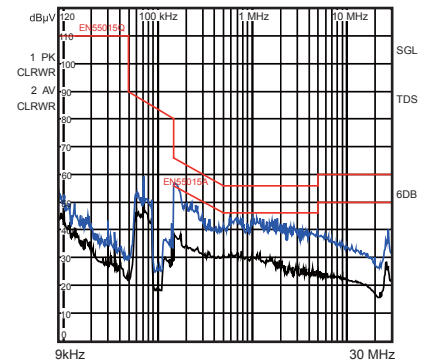

Conducted EMI, N-Line

$V_{IN}=230V_{AC}/50Hz$, Full Load, RBW=9kHz, MT=20ms

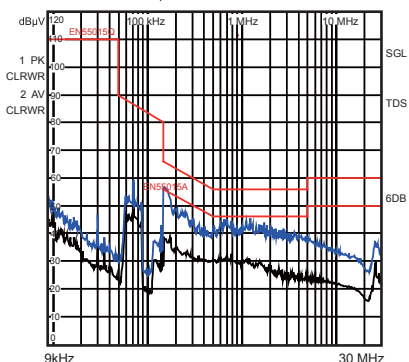

CDN Test

$V_{IN}=230V_{AC}/50Hz$, Full Load, RBW=120kHz, MT=1ms

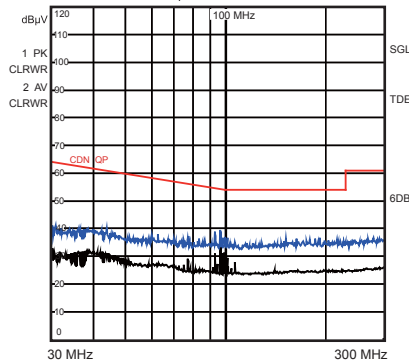

EVB TEST RESULTS (continued)

Performance waveforms are tested on the evaluation board.

 $V_{IN}=230V_{AC}/50Hz$, 18 LEDs in series, $I_{LED}=100mA$, $V_{OUT}=55V$.

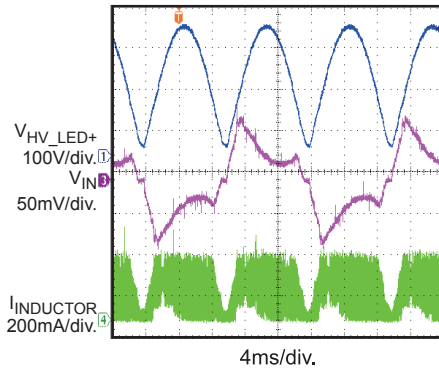
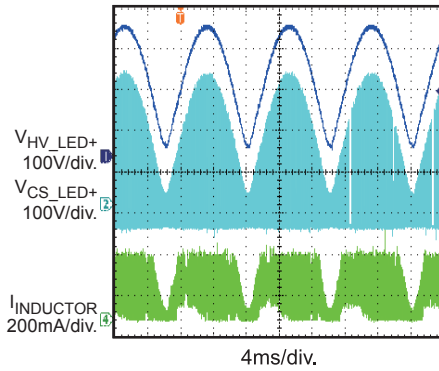
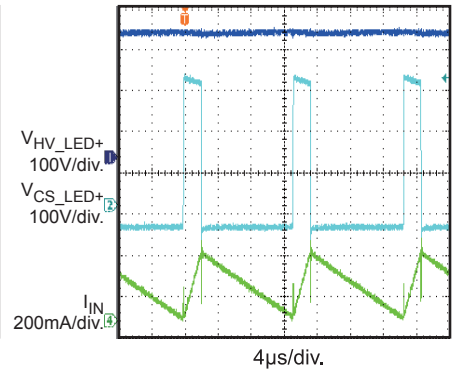
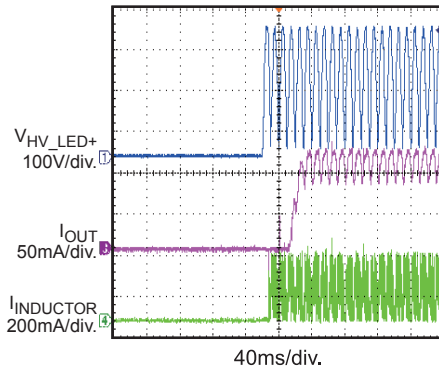
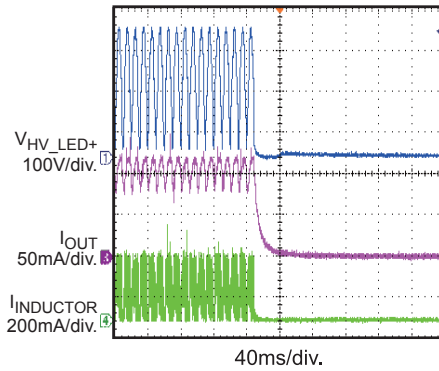
Steady State
 $V_{IN}=230V_{AC}/50Hz$, Full Load

Steady State
 $V_{IN}=230V_{AC}/50Hz$, Full Load

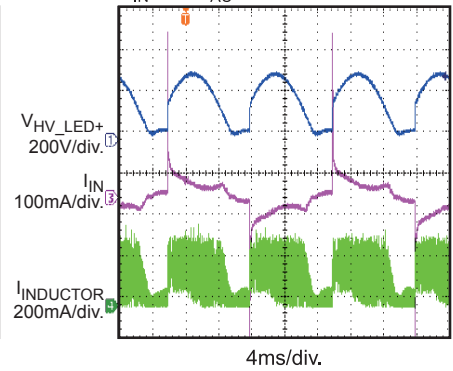
Steady State
 $V_{IN}=230V_{AC}/50Hz$, Full Load

 V_{IN} Start-Up
 $V_{IN}=230V_{AC}/50Hz$, Full Load

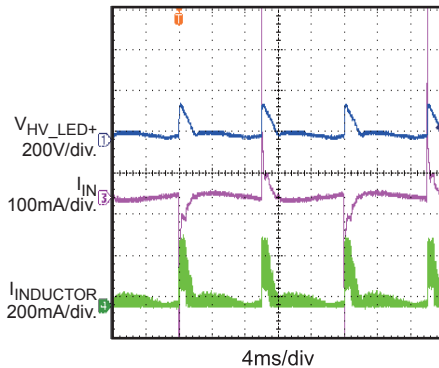
 V_{IN} Shutdown
 $V_{IN}=230V_{AC}/50Hz$, Full Load

Dimming Performance

 Max Dimming on Phase
with Leading-Edge Dimmer

 $V_{IN}=230V_{AC}/50Hz$

Dimming Performance

 Min Dimming on Phase
with Leading-Edge Dimmer

 $V_{IN}=230V_{AC}/50Hz$

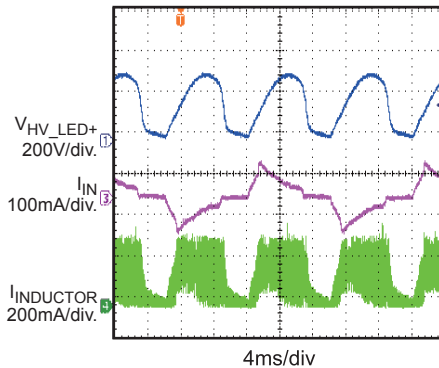
Dimming Performance

 Max Dimming on Phase
with Trailing-Edge Dimmer

 $V_{IN}=230V_{AC}/50Hz$

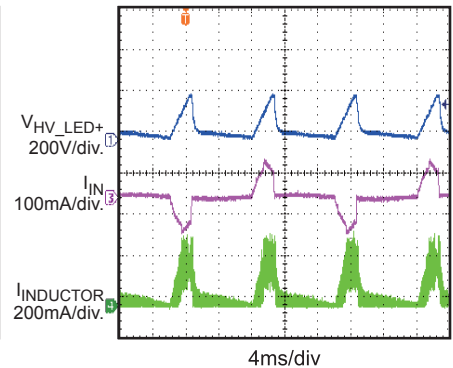
Dimming Performance

 Min Dimming on Phase
with Trailing-Edge Dimmer

 $V_{IN}=230V_{AC}/50Hz$

EVB TEST RESULTS (continued)

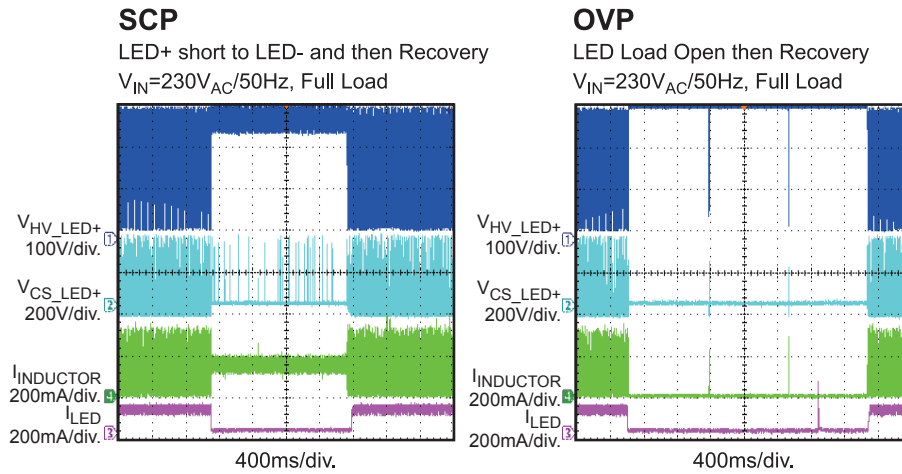
Performance waveforms are tested on the evaluation board.

 $V_{IN}=230V_{AC}/50Hz$, 18 LEDs in series, $I_{LED}=100mA$, $V_{OUT}=55V$.

QUICK START GUIDE

1. Preset AC Power Supply to $198\text{VAC} \leq V_{\text{IN}} \leq 265\text{VAC}$.
2. Turn Power Supply off.
3. Connect the LED string between “LED+” (anode of LED string) and “LED-” (cathode of LED string).
4. Connect Power Supply terminals to AC V_{IN} terminals (“L” and “N”) as shown on the board.
5. Turn AC Power Supply on after making connections.

NOTICE: The information in this document is subject to change without notice. Users should warrant and guarantee that third party Intellectual Property rights are not infringed upon when integrating MPS products into any application. MPS will not assume any legal responsibility for any said applications.