

DESCRIPTION

The EV4026-J-00C Evaluation Board is designed to demonstrate the capabilities of MP4026. The MP4026 is a primary-side-control offline LED lighting controller which can achieve high power factor and accurate LED current for an isolated lighting application in a single stage converter. It works in boundary conduction mode for reducing the MOSFET and Diode switching losses.

The EV4026-J-00C is typically designed for driving an isolated 18W T8 LED lamp with 36V_{TYP}, 500mA LED load at universal input (90V-265VAC, 50/60Hz).

The EV4026-J-00C has high performances in efficiency, line/load regulation and meets IEC61547 surges, IEC61000-3-2 Class C harmonics and EN55015 conducted EMI. It has multi-protection function as over-voltage protection, short-circuit protection, primary-side OCP, etc.

ELECTRICAL SPECIFICATION

Parameter	Symbol	Value	Units
Input Voltage	V _{IN}	90-264	VAC
Output Voltage	V _{OUT}	36	V
LED Current	I _{LED}	500	mA
Output Power	P _{OUT}	18	W
Efficiency (full load)	η	84~86	%
PF		>0.9	
THD		<20	%

FEATURES

- Small IC package: Thin SOT23-6
- Real current control without secondary-feedback circuit
- Good line/load regulation
- High power factor >0.9 over universal input voltage
- Boundary conduction mode improves efficiency
- Input UVLO
- Primary-side over current protection
- Over-voltage protection(OVP)
- Short-circuit protection(SCP)
- Primary-side over-current protection(OCP)
- Over-temperature protection(OTP)
- Fit inside T8 tube enclosure

APPLICATIONS

- T8 Tube Replacement
- Solid State Lighting
- Industrial & Commercial Lighting
- Residential Lighting

All MPS parts are lead-free and adhere to the RoHS directive. For MPS green status, please visit MPS website under Quality Assurance. "MPS" and "The Future of Analog IC Technology", are Registered Trademarks of Monolithic Power Systems, Inc.



Warning: Although this board is designed to satisfy safety requirements, the engineering prototype has not been agency approved. Therefore, all testing should be performed using an isolation transformer to provide the AC input to the prototype board.

EV4026-J-00C EVALUATION BOARD

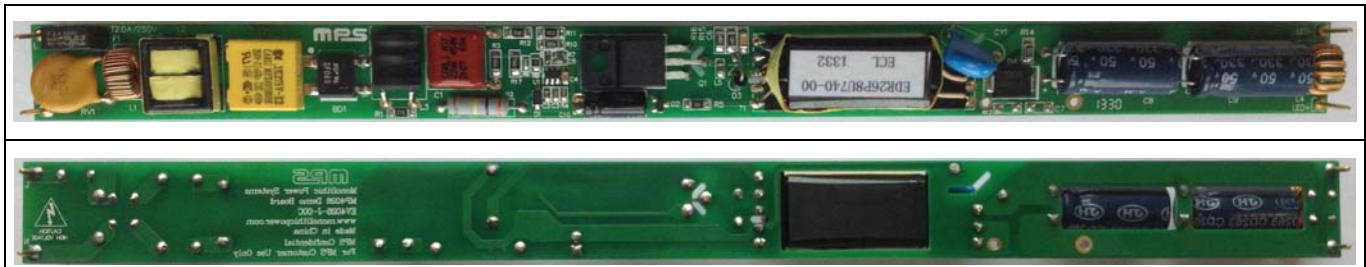

(L x W x H) 238mm x 18mm x 10mm

Board Number	MPS IC Number
EV4026-J-00C	MP4026GJ-Z

EVALUATION BOARD SCHEMATIC

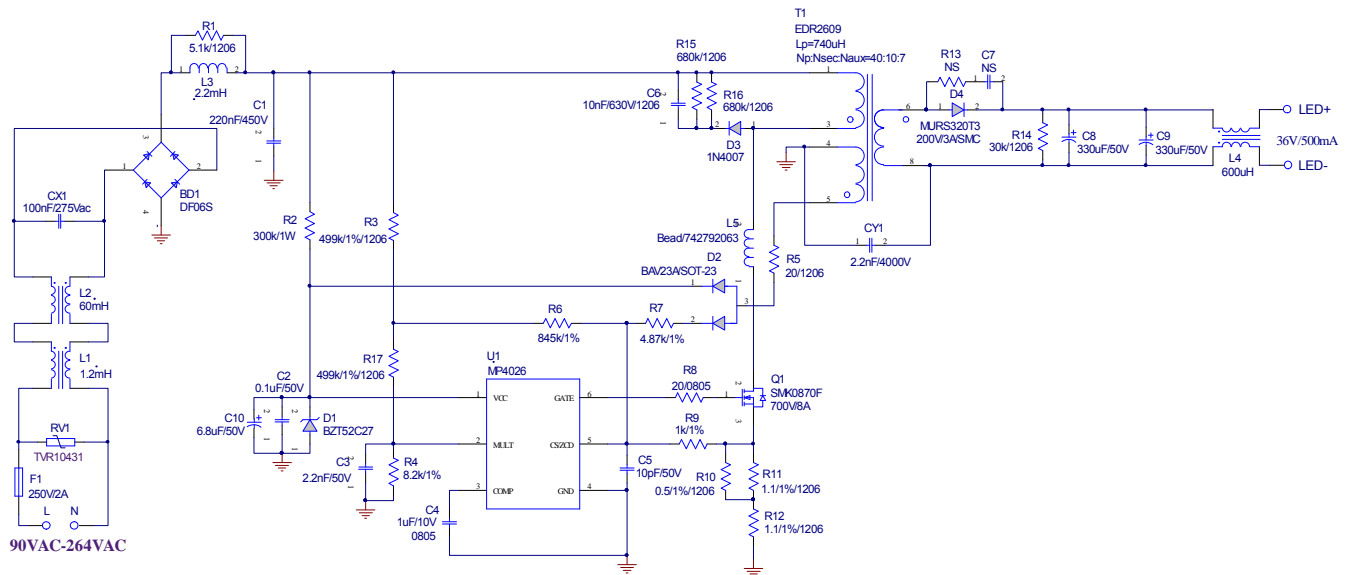

Figure 1 - Schematic

PCB LAYOUT (DOUBLE-SIDED)

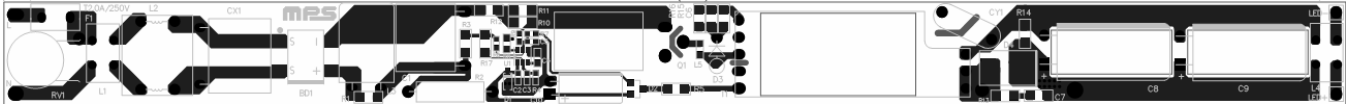

Figure 2 - Top Layer

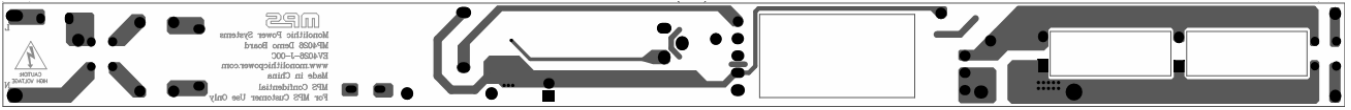

Figure 3 - Bottom Layer

CIRCUIT DESCRIPTION

The EV4026-J-00C is configured in a single-stage FLYBACK topology, it uses primary-side-control which can mostly simplify the schematic and get a cost effective BOM. It can also achieve high power factor and accurate LED current.

F1, RV1, L1, L2, L3, R1, CX1, C1 and BD1 compose the input stage. F1 fuses the AC input to protect for the component failure or some excessive short events. RV1 is used to absorb the high ring voltage of surge test. L1, L2, CX1, L3, R1 and C1 associated with L4, CY1 form the EMI filter which can meet the requirement for universal input. The bridge rectifier BD1 rectifies the input line voltage. Small bulk CBB capacitor C1 is used for a low impedance path for the primary switching current, to maintain high power factor, the capacitance of C1 should be selected with low value.

R3, R4, R17, C3 provide sine wave reference for the primary peak current to get an active PFC function. The divided voltage should be lower than the max voltage rating of MULT pin.

R2, R5, C2, C10, D2 are used to supply the power for MP4026. A 6.8 μ F electrolytic capacitor C10 is selected to maintain the supply voltage. At start-up, C10 is first charged up by the starter resistor R2 from the line voltage, when the VCC voltage passes the turn on threshold the IC starts to work and the gate begins to switch, then the VCC power supply is taken over by the auxiliary winding through R5, D2.

R7, R9, D2, C5 are used to detect the auxiliary winding to get the transformer magnetizing current zero crossing signal for realizing the valley switching operation, and also monitor the output OVP condition. The OVP voltage is set by the divider ratio of R7, R9. D2 is used to block the negative plateau voltage of auxiliary winding when MOSFET is turn on. C5 is used to decouple the high frequency noise influence on CS/ZCD pin.

R10, R11, R12 are primary sensing resistors for primary side current control. The value of R10, R11 and R12 set the output LED current. R6 is used to form a feedforward from input line voltage to optimize the line regulation. C6, R15, R16, D3 are used to damp the leakage inductance energy so the drain voltage can be suppressed at a safe level.

Diode D4 rectifies the secondary winding voltage and the capacitor C8, C9 are the output filter. The resistor R14 is placed as pre-load to limit the output voltage rise too high in open load condition.

EV4026-J-00C BILL OF MATERIALS

Qty	Ref	Value	Description	Package	Manufacture	Manufacturer_PN
1	BD1	DF06S	Rectifier Bridge, 600V, 1A	SMD	SEP	DF06S
1	C1	220nF/450V	CBB, 450V	DIP	Carli	TF224K2Y109L270D9R
1	C2	100nF/50V	Ceramic Cap, 50V, X7R	0603	Murata	GRM188R71H104KA93D
1	C3	2.2nF/50V	Ceramic Cap, 50V, X7R	0603	Murata	GRM188R71H222KA01D
1	C4	1µF/10V	Ceramic Cap, 10V, X7R	0805	Murata	GRM21BR71A105KA01L
1	C5	10pF/50V	Ceramic Cap, 50V, COG	0603	Murata	GRM1885C1H100JA01
1	C6	10nF/630V	Ceramic Cap, 630V, X7R	1206	Murata	GRM31BR72J103KW01L
1	C7	NS				
2	C8, C9	330µF/50V	Electrolytic Capacitor, 50V	DIP	Jianghai	CD263-50V330
1	C10	6.8µF/50V	Electrolytic Capacitor, 50V	DIP	Sancon	CF120302-5
1	CX1	100nF/275V	Film Capacitor, X2, 275V	DIP	Carli	PX104K3ID19L270D9R
1	CY1	2.2nF/4000V	Y1 Capacitor, 4000V	DIP	Hongke	JN12E222MY02N
1	D1	BZT52C27	Zener Diode, 27V	SOD-123	Diodes	BZT52C27
1	D2	BAV23A	Diode, 0.2A, 200V	SOT-23	Diodes	BAV23A-7
1	D3	1N4007	Diode, 1A, 1000V	DO-41	Diodes	1N4007
1	D4	MURS320T3	Diode, 3A, 200V	SMC	ON Semi	MURS320T3
1	F1	250V/2A	Fuse	DIP	COOPER BUSSMANN	SS-5-2A
1	L1	1.2mH	Common Inductor	DIP	Emei	TP4M1.2-02
1	L2	60mH	Common Inductor	DIP	OEMA	
1	L3	2.2mH	Inductor, 2.2mH, 0.5A	DIP	OEMA	
1	L4	600µH	Common Inductor	DIP	Emei	TP4U300-00
1	L5	742792063	EMI Suppression Ferrite Bead	0805	Würth	742792063
1	Q1	SMK0870F	N-MOS, 8A, 700V	TO-220F-3L	AUK	SMK0870F
1	R1	5.1kΩ	Thick Film Chip RES, 5%	1206	LIZ	CR06T05NJ5K1
1	R2	300kΩ	Metal Film RES, 1W	DIP	Any	Any
2	R3, R17	499kΩ	Thick Film Chip RES, 1%	1206	Yageo	RC1206FR-07499KL
1	R4	8.2kΩ	Thick Film Chip RES, 1%	0603	Yageo	RC0603FR-078K2L
1	R5	20Ω	Thick Film Chip RES, 5%	1206	Yageo	RC1206JR-0720RL
1	R6	845kΩ	Thick Film Chip RES, 1%	0603	Yageo	RC0603FR-07845KL
1	R7	4.87kΩ	Thick Film Chip RES, 1%	0603	Yageo	RC0603FR-074K87L
1	R8	20Ω	Thick Film Chip RES, 5%	0805	Yageo	RC0805JR-0720RL

EV4026-J-00C BILL OF MATERIALS (continued)

Qty	Ref	Value	Description	Package	Manufacturer	Manufacturer_P/N
1	R9	1kΩ	Thick Film Chip RES, 1%	0603	Yageo	RC0603FR-071KL
1	R10	500mΩ	Thick Film Chip RES, 1%	1206	Yageo	RC1206FR-070R5L
2	R11, R12	1.1Ω	Thick Film Chip RES, 1%	1206	Yageo	RC1206FR-071R1L
1	R13	NS				
1	R14	30kΩ	Thick Film Chip RES, 1%	1206	Yageo	RC1206FR-0730KL
2	R15, R16	680kΩ	Thick Film Chip RES, 1%	1206	Yageo	RC1206FR-07680KL
1	RV1	430V/2500A	Zinc Oxide Varistor	DIP	TKS	TVR10431KSY
1	T1	FX0327	EDR2609, Lp=740μH, Np:Ns:Naux=40:10:7	EDR2609	Emei	EDR26P8U740-00
1	U1	MP4026	LED Lighting Controller	FCTSOT-6	MPS	MP4026GJ-Z R0

TRANSFORMER SPECIFICATION

Electrical Diagram

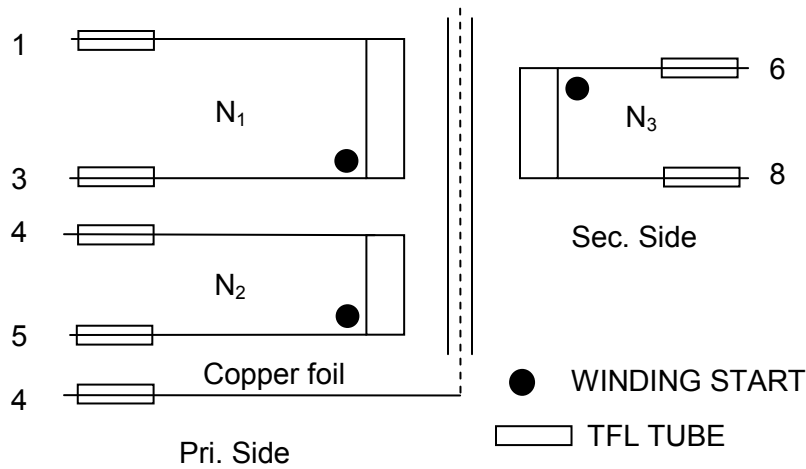

Figure 4 – Transformer Electrical Diagram

Notes: Wind copper foil (3.0mm x 0.025mm) to circle the side of transformer and connect to PIN4

Winding Diagram

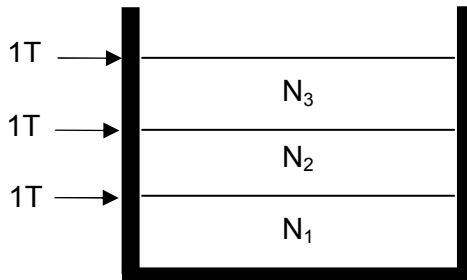

Figure 5 – Winding Diagram

Winding Order

Winding No.	Tape Layer Number	Start & End	Magnet WireΦ(mm)	Turns
N ₁	1	3→1	0.3*1	40
N ₂	1	5→4	0.18*1	7
N ₃	1	6→8	0.4*1 (T.I.W)	10

Electrical Specifications

Electrical Strength	1 second, 50Hz, from Pins 1, 3, 4, 5 to 6, 8	3500VAC
Primary Inductance	Pins 1-3, all other windings open, measured at 10kHz, 0.1 VRMS	740 μ H \pm 10%

Materials

Item	Description
1	Core: EDR2609, UI=2300 \pm 25%, AL=462.5nH/N ² \pm 3% GAPPED, PC4
2	Bobbin: EDR26 T-H, 8PINS, 1SEC, T375J, PINL=4.0 \pm 0.2mm
3	Wire: Φ 0.18mm, Φ 0.20mm, Φ 0.30mm, 2UEW, CLASS F
4	Triple Insulation Wire: Φ 0.40mm, TRW(B)
5	Tape: 4.0mm(W) \times 0.06mm(TH), Yellow; 5.0mm(W) \times 0.06mm(TH), Yellow
6	Copper foil: 3.0mm(W) \times 0.025mm(TH)
7	Tube:AWG#23 CLEAR; AWG#30 CLEAR
8	Varnish: BC-346A
9	Epoxy: E-500
10	Solder Bar: SN99.5/Cu0.5

EVB TEST RESULTS

Performance Data

f (Hz)	V_{IN} (VAC)	P_{IN} (W)	V_{OUT} (V)	I_{12LEDs} (mA)	P_{OUT} (W)	η (%)	PF	I_{11LEDs} (mA)	I_{10LEDs} (mA)	I_{9LEDs} (mA)	I_{8LEDs} (mA)	I_{7LEDs} (mA)	I_{6LEDs} (mA)
60	90	21.64	36.36	500	18.18	84.01	0.994	505	511	514	519	525	528
	100	21.49	36.35	501	18.21	84.74	0.993	506	511	514	519	525	528
	110	21.37	36.35	502	18.25	85.39	0.992	506	512	514	519	525	529
	120	21.28	36.34	502	18.24	85.73	0.99	507	512	514	519	525	529
	135	21.21	36.34	502	18.24	86.01	0.987	507	512	514	519	525	529
	150	21.16	36.33	502	18.24	86.19	0.983	507	512	514	519	525	529
	170	21.13	36.32	503	18.27	86.46	0.975	507	512	515	520	526	530
50	185	21.17	36.31	503	18.26	86.27	0.969	508	513	515	521	527	531
	200	21.25	36.3	503	18.26	85.92	0.961	508	514	516	522	527	532
	220	21.29	36.29	504	18.29	85.91	0.947	509	514	517	523	529	534
	230	21.34	36.29	504	18.29	85.71	0.94	509	515	517	524	529	535
	240	21.39	36.28	505	18.32	85.65	0.932	510	516	518	524	530	535
	250	21.45	36.28	505	18.32	85.41	0.923	510	516	519	525	531	536
	264	21.54	36.27	506	18.35	85.20	0.91	511	517	519	526	532	537

Harmonic Data

The design passes EN6100-3-2 Class C (active input power $\leq 25W$) requirement.

V_{IN} (VAC/Hz)	P_{IN} (W)	I_{IN} (mA)	THD (%)	V_{IN} (VAC/Hz)	P_{IN} (W)	I_{IN} (mA)	THD (%)
115/60	21.51	188.2	9.36	230/50	21.32	98.35	14.28
Harmonic Order	Limit (mA)	Content (mA)	Test Result (Pass/Fail)	Harmonic Order	Limit (mA)	Content (mA)	Test Result (Pass/Fail)
3	140.90	16.9	Pass	3	71.16	12.52	Pass
5	78.74	3.12	Pass	5	39.77	3.92	Pass
7	41.44	0.67	Pass	7	20.93	3.16	Pass
9	20.72	0.55	Pass	9	10.46	1.8	Pass
11	14.50	0.65	Pass	11	7.33	0.58	Pass
13	12.27	0.76	Pass	13	6.19	0.38	Pass
15	10.64	0.85	Pass	15	5.37	0.45	Pass
17	9.38	0.87	Pass	17	4.74	1.21	Pass
19	8.40	0.78	Pass	19	4.24	1.47	Pass
21	7.60	0.88	Pass	21	3.83	1.02	Pass
23	6.94	0.85	Pass	23	3.50	0.47	Pass
25	6.38	0.73	Pass	25	3.22	0.46	Pass
27	5.91	0.72	Pass	27	2.98	0.44	Pass
29	5.50	0.77	Pass	29	2.77	0.38	Pass
31	5.15	0.65	Pass	31	2.59	0.52	Pass
33	4.83	0.66	Pass	33	2.44	0.63	Pass
35	4.56	0.61	Pass	35	2.30	0.47	Pass
37	4.31	0.54	Pass	37	2.17	0.44	Pass
39	4.09	0.59	Pass	39	2.06	0.6	Pass

Electric Strength Test

Primary circuit to secondary circuit electric strength testing was completed according to IEC61347-1 and IEC61347-2-13.

Input and output was shorted respectively. 3750VAC/50Hz sine wave applied between input and output for 1min, and operation was verified.

Surge Test

Line to Line 500V and Line to Power Earth 1kV surge testing was completed according to IEC61547. Input voltage was set at 230VAC/50Hz. Output was loaded at full load and operation was verified following each surge event.

Surge Level (V)	Input Voltage (VAC)	Injection Location	Injection Phase (°)	Test Result (Pass/Fail)
500	230	L to N	90	Pass
-500	230	L to N	270	Pass
1000	230	L to PE	90	Pass
-1000	230	L to PE	270	Pass
1000	230	N to PE	90	Pass
-1000	230	N to PE	270	Pass

EVB TEST RESULTS

Performance waveforms are tested on the evaluation board.
 12 LEDs in series, $I_{LED}=500mA$, $V_{OUT}=36V$.

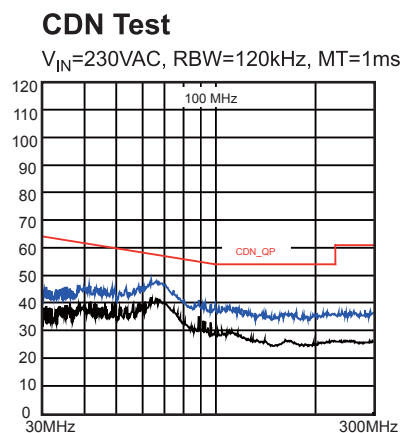
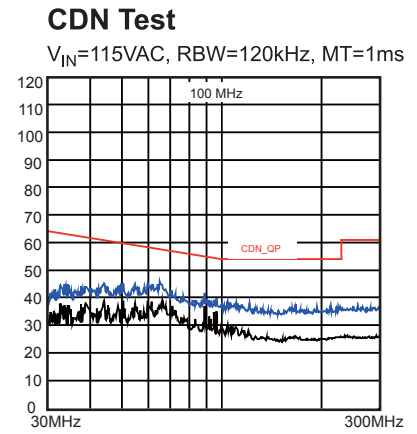
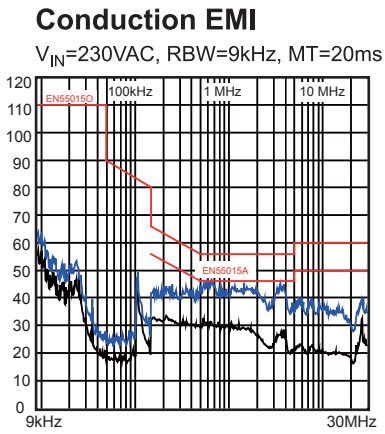
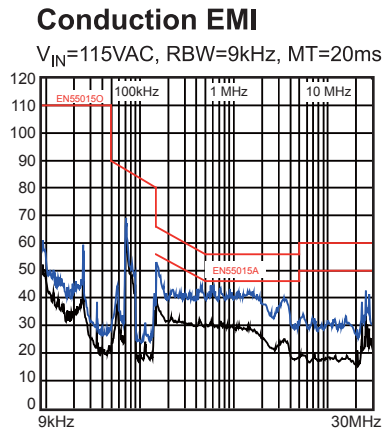
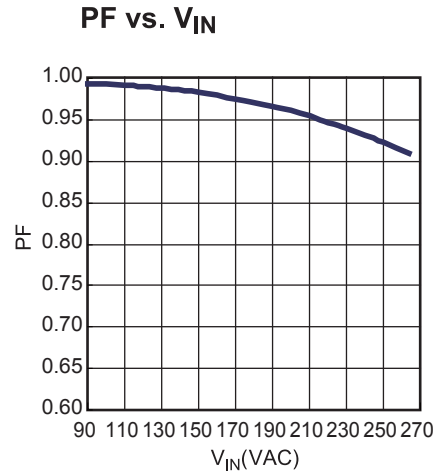
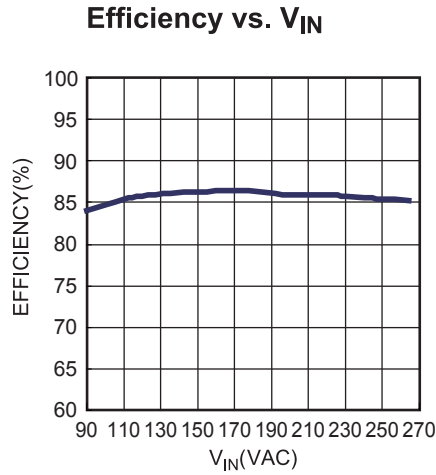
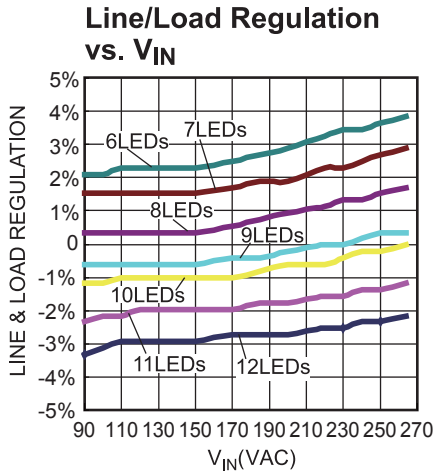

EVB TEST RESULTS (continued)

Performance waveforms are tested on the evaluation board.
 12 LEDs in series, $V_{IN}=120VAC/60Hz$, $I_{LED}=500mA$, $V_{OUT}=36V$.

Steady State

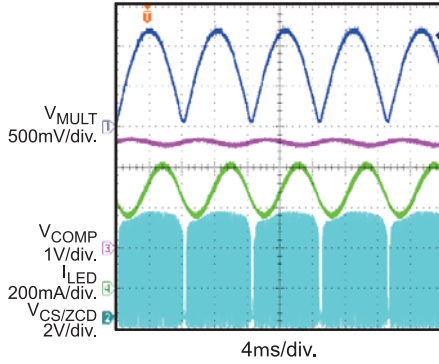

Steady State

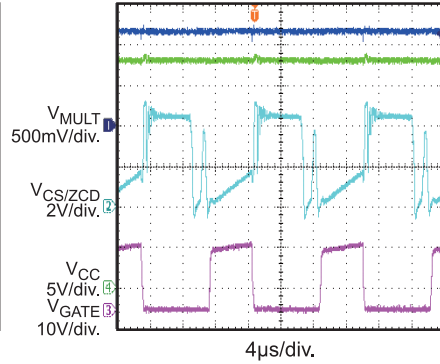

Steady State

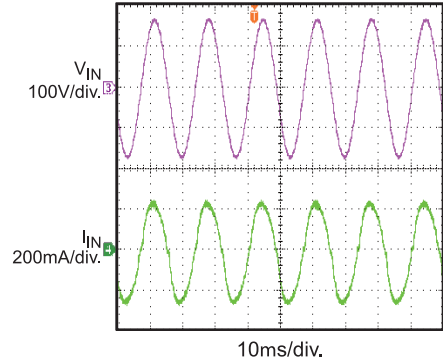

V_{IN} Start-Up

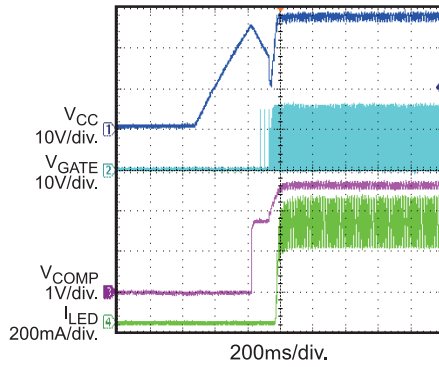

V_{IN} Shut-Down

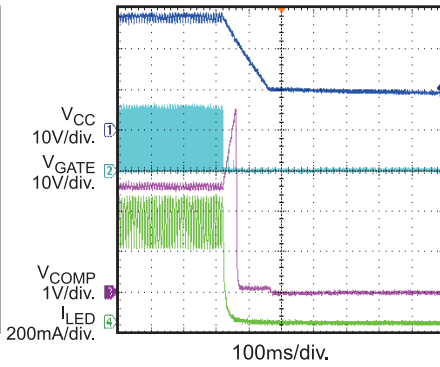

Primary-side OCP

Short Primary Winding @ Working then Recovery

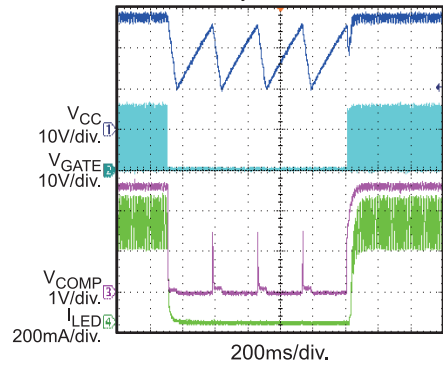

SCP

Short LED @ Working then Recovery

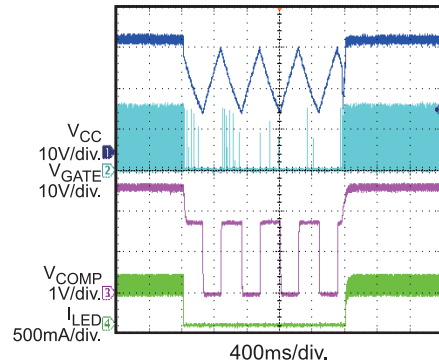

OVP

Open LED @ Working then Recovery

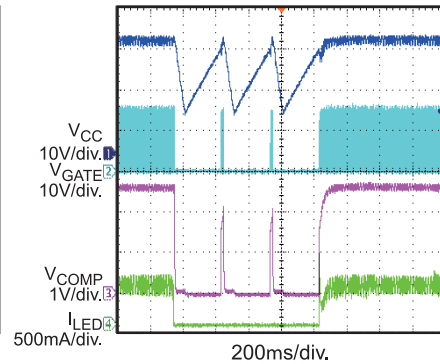

OVP

Open LED @ Working then Recovery

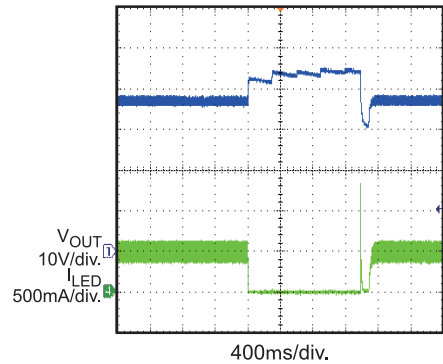

EVB TEST RESULTS (continued)

Performance waveforms are tested on the evaluation board.
 12 LEDs in series, $V_{IN}=230VAC/50Hz$, $I_{LED}=500mA$, $V_{OUT}=36V$.

Steady State

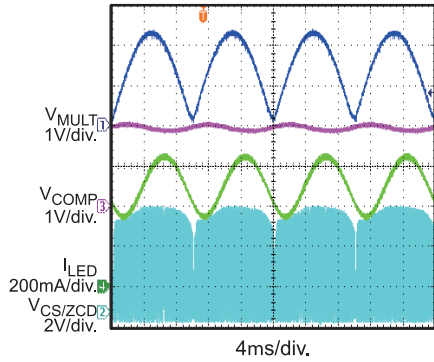

Steady State

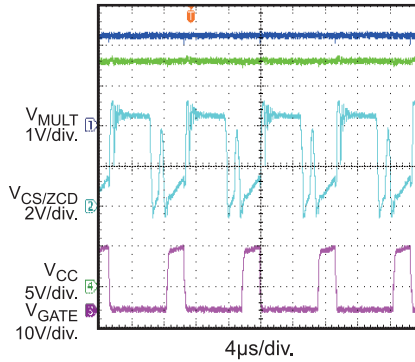

Steady State

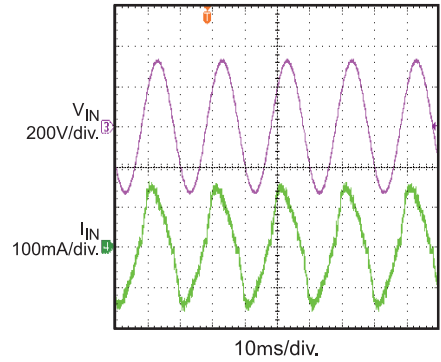

V_{IN} Start-Up

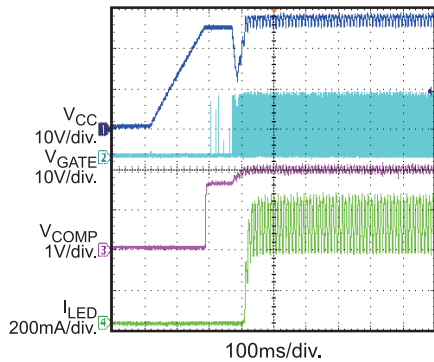

V_{IN} Shut-Down

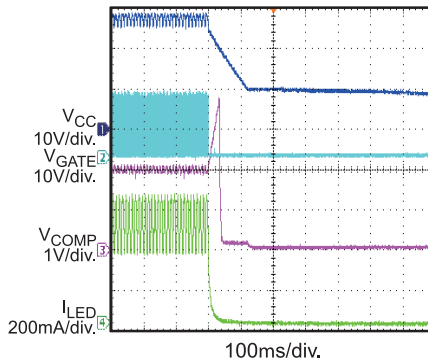

Primary-side OCP

Short Primary Winding @ Working then Recovery

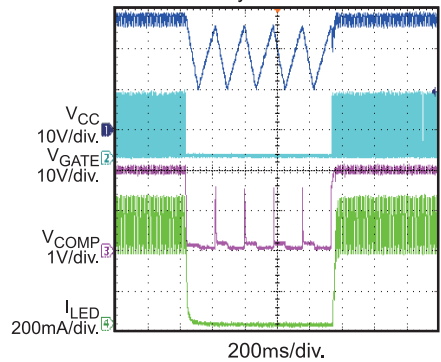

SCP

Short LED @ Working then Recovery

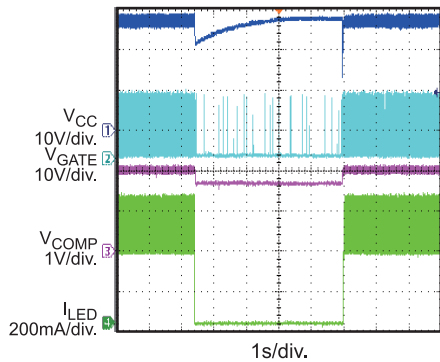

OVP

Open LED @ Working then Recovery

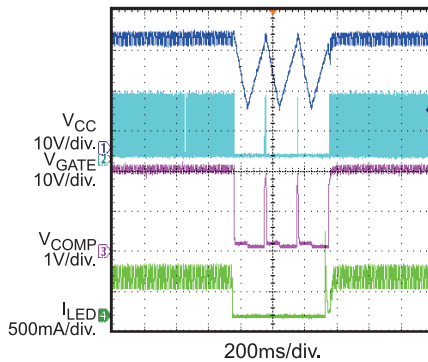

OVP

Open LEDs @ Working then Recovery

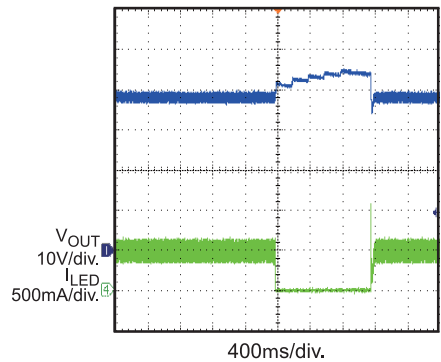

QUICK START GUIDE

1. Preset AC Power Supply to $90\text{VAC} \leq V_{\text{IN}} \leq 265\text{VAC}$.
2. Turn Power Supply off.
3. Connect the LED string between “LED+” (anode of LED string) and “LED-” (cathode of LED string).
4. Connect Power Supply terminals to AC V_{IN} terminals as shown on the board.
5. Turn AC Power Supply on after making connections.

NOTICE: The information in this document is subject to change without notice. Please contact MPS for current specifications. Users should warrant and guarantee that third party Intellectual Property rights are not infringed upon when integrating MPS products into any application. MPS will not assume any legal responsibility for any said applications.