



The Future of Analog IC Technology®

EV4000DS-00D

350mA Off-Line WLED Driver Evaluation Board For 90-140VAC Input

DESCRIPTION

The EV4000DS-00D is an evaluation board for the MP4000. The EV4000DS-00D is a high efficiency step-down converter designed for driving high brightness Light Emitting Diodes (LEDs).

The EV4000DS-00D can supply a maximum output current of 350mA to drive 10 to 40V LED strings from a wide input voltage 90 to 140VAC with 50/60Hz.

ELECTRICAL SPECIFICATION

Parameter	Symbol	Value	Units
Input Voltage	VAC	90 – 140	V
Output Voltage	V _{OUT}	10 – 40	V
Output Current	I _{OUT}	350	mA

FEATURES

- Constant-current LED Driver
- Power MOSFET Zero-Current Turn On
- High Efficiency and Reliability in Boundary Mode Operation
- Low 0.9mA Operation Current
- PWM or DC Input Burst Dimming Control
- Hiccup Short Circuit Protection
- UVLO, Thermal Shutdown
- Maximum Frequency is Limited to 110kHz
- Available in SOIC8 Package

APPLICATIONS

- DC/DC or AC/DC LED Driver Application
- General Illumination
- Industrial LED Lighting
- LED Light

For MPS green status, please visit MPS website under Quality Assurance.

“MPS” and “The Future of Analog IC Technology”, are Registered Trademarks of Monolithic Power Systems, Inc.



Warning: Although this board is designed to satisfy safety requirements, the engineering prototype has not been agency approved. Therefore, all testing should be performed using an isolation transformer to provide the AC input to the prototype board.

EV4000DS-00D EVALUATION BOARD



FRONT



BACK

(L x W x H) 2.4" x 1.2" x 0.5"

Board Number	MPS IC Number
EV4000DS-00D	MP4000DS

Efficiency

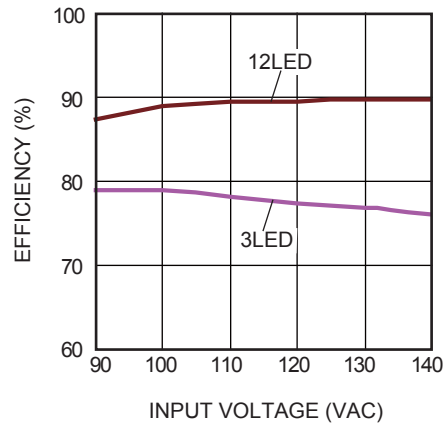

EVALUATION BOARD SCHEMATIC

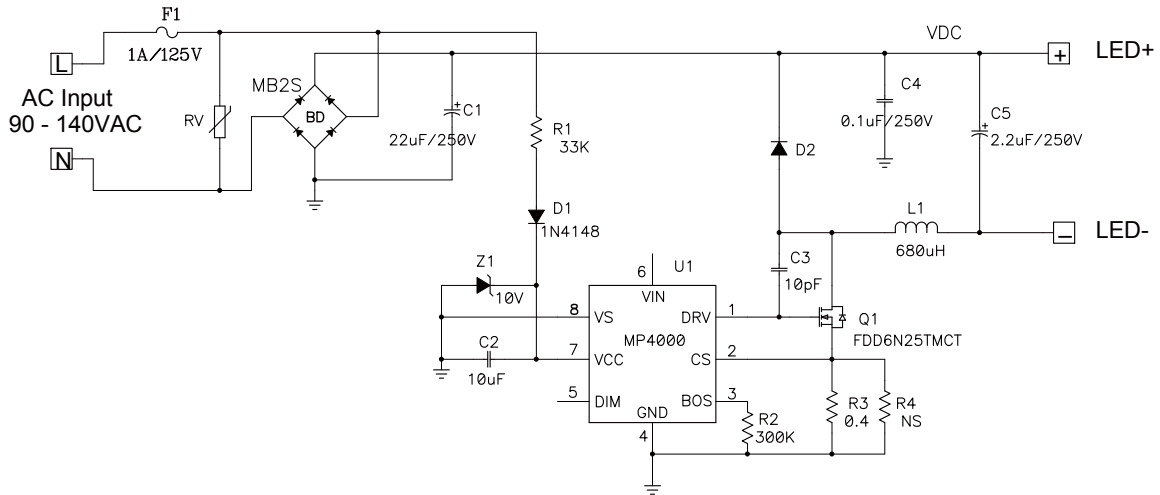

EV4000-00D BILL OF MATERIALS

Qty	Ref	Value	Description	Package	Reference	Manufacturer P/N
1	C1	22µF	CAP., Alum., 22µF 250V	12.5x20	Panasonic	ECA-2EM220
1	C2	10µF	Ceramic Cap., 16V, X5R	0805	TDK	C2012X5R1C106M
1	C3	10pF	Ceramic Cap., 250V, X7R	0805	Johanson Dielectrics	251R15S100JV4E
1	C4	0.1µF	Ceramic Cap., 250V, X7R	1206	TDK	C3216X7R2E104K
1	C5,	2.2µF	2.2µF Cap., 250V, 10%	6.3x11.2	Panasonic	ECA-2EHG010
1	D2	1A	400V 1A fast Diode	Through Hold	STmicroelectronics	STTH1R04
1	D1	Diode	1N4148, 80V, 0.1A	SOD-523	Rohm Semi	1SS400TE61
1	BD	0.5A	Bridg Diode, SMD, 200V, 0.5A	SOIC-4	Fairchile Semi	MB2S
1	Z1	10V	Zener diode	SOD-123	Diode	DDZ9697-7
1	F1	1A	Fuse 1A/125V	Through Hold	LittleFuse	0251001.MAT1L
1	L1	680µH	Inductor, 680µH/1.3A	12x12x10	WURTH Elektronik	7447709681
1	R1	33kΩ	1/4W Res., 5%	Through Hold	Digikey	
1	R2,	300kΩ	Film Res., 1%	0603	Digikey	
1	R3	0.4Ω	1/3W Film Res., 1%	0805	Cyntec	RLT1220-F-R400-FNH
1	R4	NS				
1	RV	ZNR	240V Transient Absorbers	Through Hold	Panasonic	ERZ-V10D241
1	Q1		N_C MOSFET 250V	D Pak	Fairchild Semi	FDD6N25TMCT-ND
1	U1		DC-DC Converter	SOIC8	MPS	MP4000DS

EVB TEST RESULTS

Performance waveforms are tested on the evaluation board.

$V_{IN} = 90V_{AC}$ to $140V_{AC}$, $V_{OUT} = 10V$ to $40V$, $L = 680\mu H$, $T_A = 25^\circ C$, unless otherwise noted.

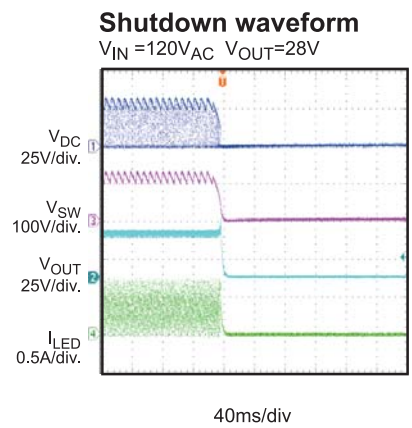
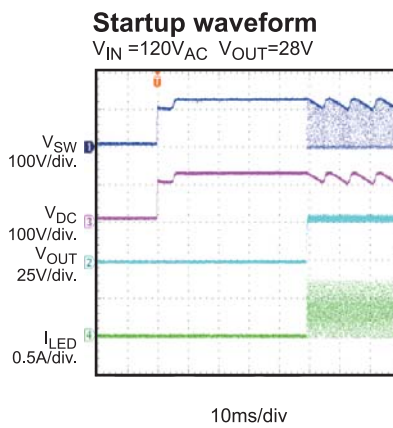
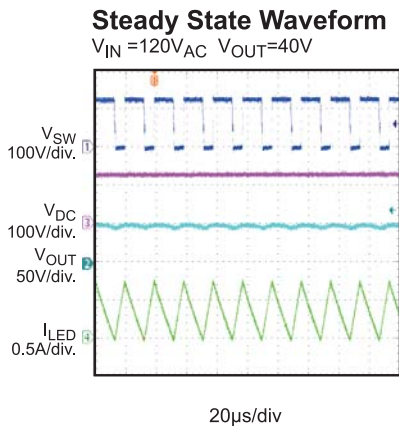
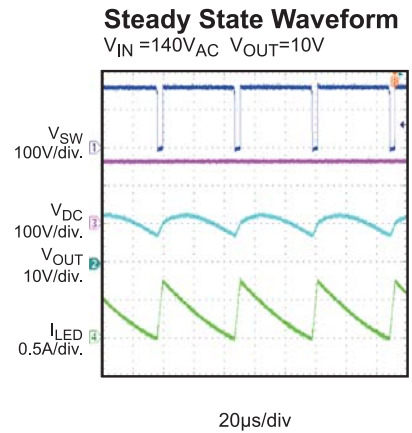
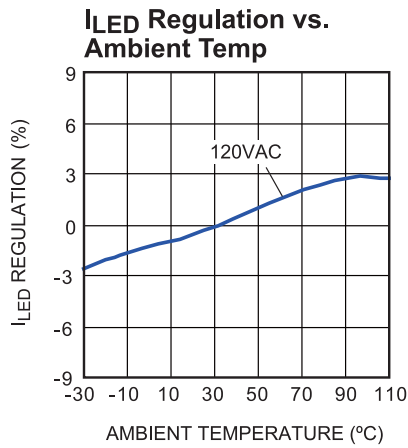
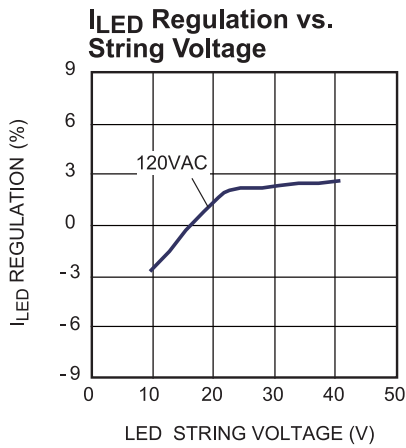
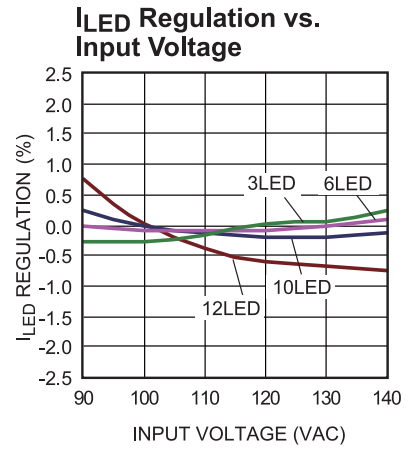
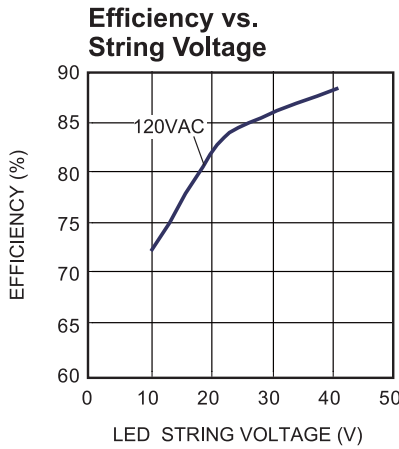
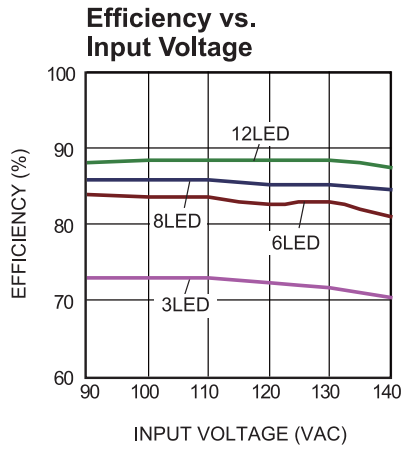

PRINTED CIRCUIT BOARD LAYOUT

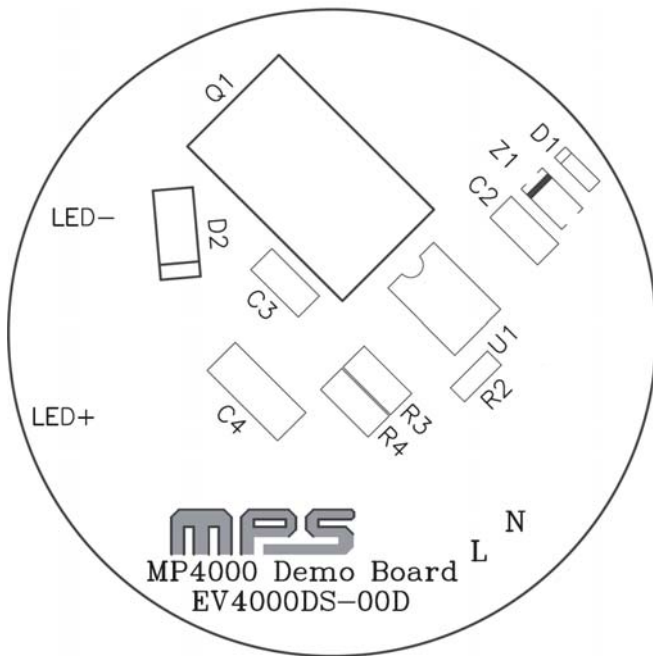

Figure 1—Top Silk Layer

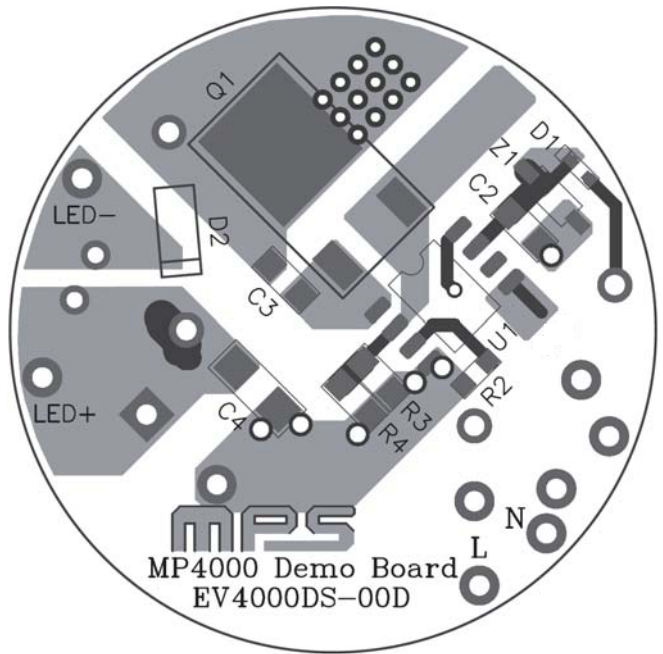

Figure 2—Top Layer

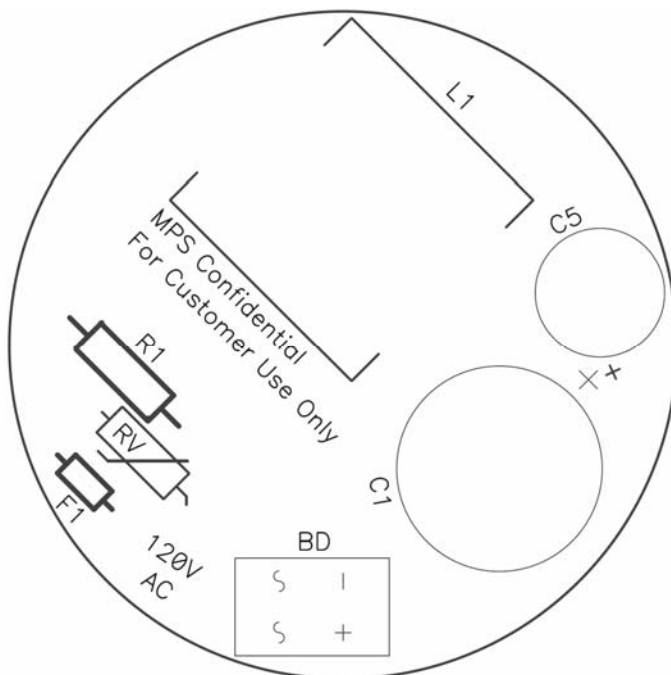

Figure 3—Bottom Silk Layer

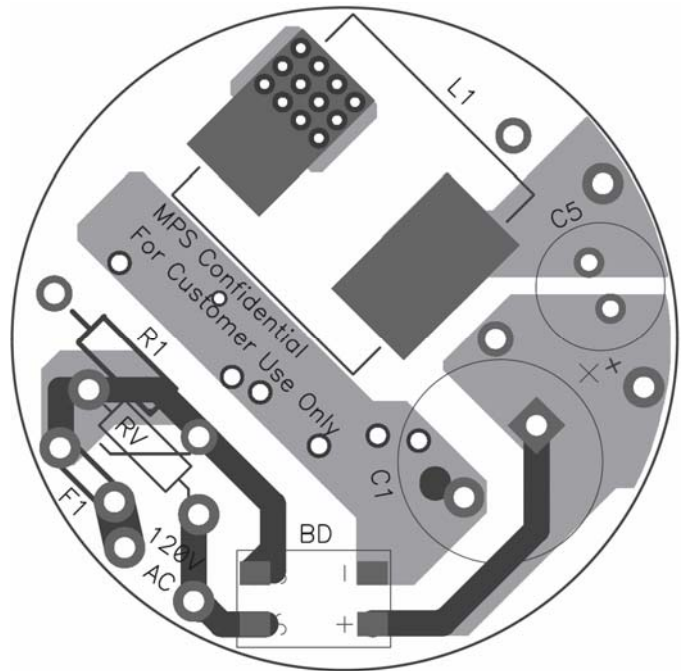

Figure 4—Bottom Layer

QUICK START GUIDE

1. Turn off the AC Power Supply.
2. Connect the LED string between “+” (anode of LED string) and “-” (cathode of LED string).
3. Connect the AC input voltage between the AC input terminal (“N” and “L”) as shown on the board.
4. Set the AC Power Supply to $90V \leq AC \text{ input} \leq 140V$.
5. Turn Power Supply on after making connections.

CAUTION:

There is no galvanic isolation on the EVB board. Be careful when doing the test. To prevent damage to equipments and EVB board, isolation is suggested to either the test equipments or the EVB board.

NOTICE: The information in this document is subject to change without notice. Please contact MPS for current specifications. Users should warrant and guarantee that third party Intellectual Property rights are not infringed upon when integrating MPS products into any application. MPS will not assume any legal responsibility for any said applications.