

### DESCRIPTION

EV3910-K-00B Evaluation Board is designed to demonstrate the capabilities of MP3910. MP3910 is a Peak Current Mode PWM controller that can drive an external MOSFET capable of handling >10A current. It can accommodate off-line, Telecom and non-isolated and isolated applications.

While designed for Boost applications, the 1A gate driver minimizes the power loss of the external MOSFET while allowing the use of a wide variety of standard threshold devices. Additionally, MP3910 has pulse skipping Mode function that improves the efficiency with light load or no load.

The MP3910 is available in MSOP10 package.

### ELECTRICAL SPECIFICATIONS

Parameter	Symbol	Value	Units
Input voltage	$V_{IN}$	10-20	V
Output voltage	$V_{OUT}$	24	V
Output current	$I_{OUT}$	2	A

### FEATURES

- Wide Supply Voltage Range of 5V to 35V
- 1A 12V MOSFET Gate Driver
- External Soft-Start
- Pulse Skipping Operation with Light Load
- Programmable Switching Frequency (30kHz-to-400kHz)
- Synchronizable from 80kHz-to-400kHz
- Cycle-by-Cycle Current Limit
- Over Voltage Protection
- Available in an MSOP10 Package

### APPLICATIONS

- Telecom Isolated Power
- Brick Modules
- Off-line Controller
- General Step Up Applications

All MPS parts are lead-free and adhere to the RoHS directive. For MPS green status, please visit MPS website under Products, Quality Assurance page.

"MPS" and "The Future of Analog IC Technology" are Registered Trademarks of Monolithic Power Systems, Inc.

### EV3910-K-00B EVALUATION BOARD



(L x W x H) 2.5" x 2.5" x 0.5"  
(6.35cm x 6.35cm x 1.2cm)

Board Number	MPS IC Number
EV3910-K-00B	MP3910GK

Efficiency vs. Load Current

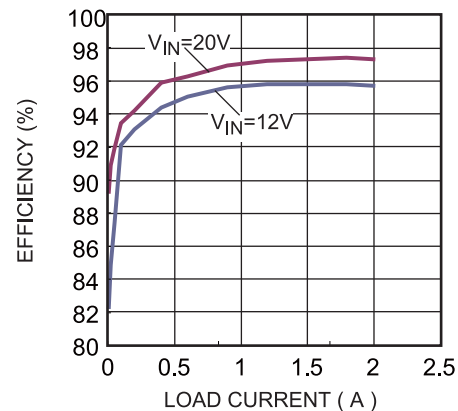



**EV3910-K-00B BILL OF MATERIALS**

Qty	Ref	Value	Description	Package	Manufacturer	Part Number
1	C1	10 $\mu$ F	Ceramic Cap., 25V,X7R	1210	muRata	GRM32DR71E106KA12L
1	C2	0.22 $\mu$ F	Ceramic Cap.,16V,X7R	0603	muRata	GRM188R71C224KA01D
2	C3, C6	NC				
1	C4	1.0 $\mu$ F	Ceramic Cap.,25V,X7R	0805	muRata	GRM21BR71E105KA99L
1	C5	15nF	Ceramic Cap.,50V,X7R	0603	muRata	GRM188R71H153KA01D
1	C7	4.7 $\mu$ F	Ceramic Cap.,16V,X7R	0805	muRata	GRM21BR71C475KA73L
3	C8, C9, C10	10 $\mu$ F	Ceramic Cap.,50V,X5R	1210	muRata	GRM32ER61H106KA12L
1	R1	453K	Film Res,1%	0603	ROYAL	RL0603FR-07453KL
1	R2	100K	Film Res,1%	0603	ROYAL/LiZhi	RL0603FR-07100KL
1	R3	8.06K	Film Res,1%	0603	ROYAL	RL0603FR-078K06L
1	R4	7.5K	Film Res,1%	0603	ROYAL	RL0603FR-077K5L
1	R5	180K	Film Res,1%	0603	ROYAL	RL0603FR-07180KL
1	R6	10K	Film Res,1%	0603	ROYAL	RL0603FR-0710KL
2	R7, R10	0R	Film Res,1%	0603	Yageo	RC0603FR-070RL
1	R8	4.7R	Film Res,1%	0603	ROYAL	RL0603FR-074R7L
1	R9	0.025		2512	Yageo	RL2512FK-070R025L
1	D1	1N4148	Diode 75V 250mW	SOD-323	Diodes Inc	1N4148WS-7
1	D2	SS5P4	Switching Diode 40V 5A	TO-277A	Vishay	SS5P4
1	L1	10 $\mu$ H	In=9A,Isat=10A		Würth	744 332 100 0
1	L2	0.47 $\mu$ H	IR=6.8A,Isat=14.5A	SMD	Würth	744 373 240 047
1	Q1	SIR462	Vds=30V, Rds-on=7.9m $\Omega$	PowerPAK <sup>®</sup> SO-8	Vishay	SiR462DP
1	U1	MP3910	Controller	MSOP-10	MPS	MP3910GK

## EVB TEST RESULTS

Performance waveforms are tested on the evaluation board.

$V_{IN}=12V$ ,  $V_{OUT}=24V$ ,  $I_{OUT}=2A$ ,  $T_A=25^{\circ}C$ , unless otherwise noted.

**Efficiency vs. Load Current**

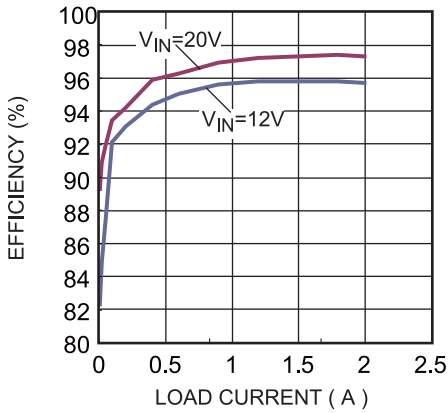

**Load Regulation vs. Load Current**

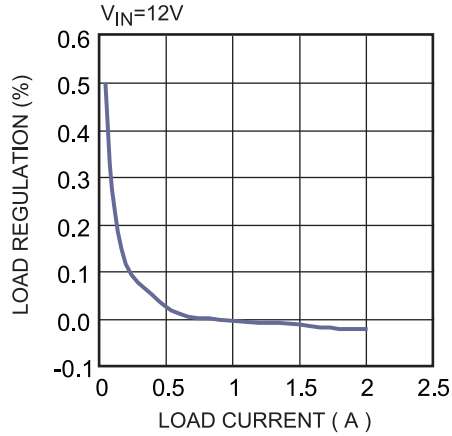

**Line Regulation vs. Input Voltage**

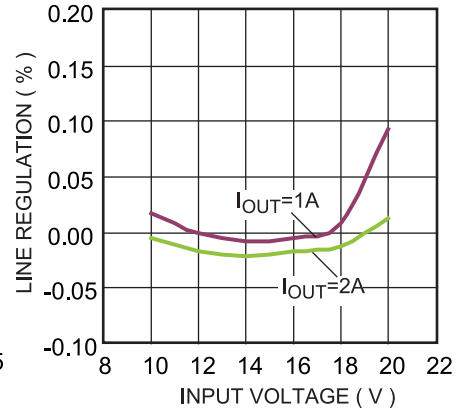

**Magnitude and Phase vs. Frequency**

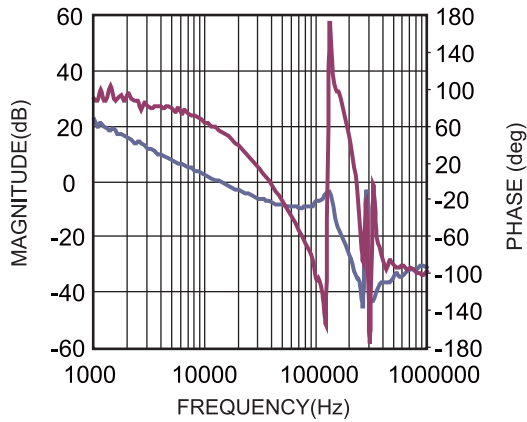

## EVB TEST RESULTS *(continued)*

Performance waveforms are tested on the evaluation board.

$V_{IN}=12V$ ,  $V_{OUT}=24V$ ,  $I_{OUT}=2A$ ,  $T_A=25^{\circ}C$ , unless otherwise noted.

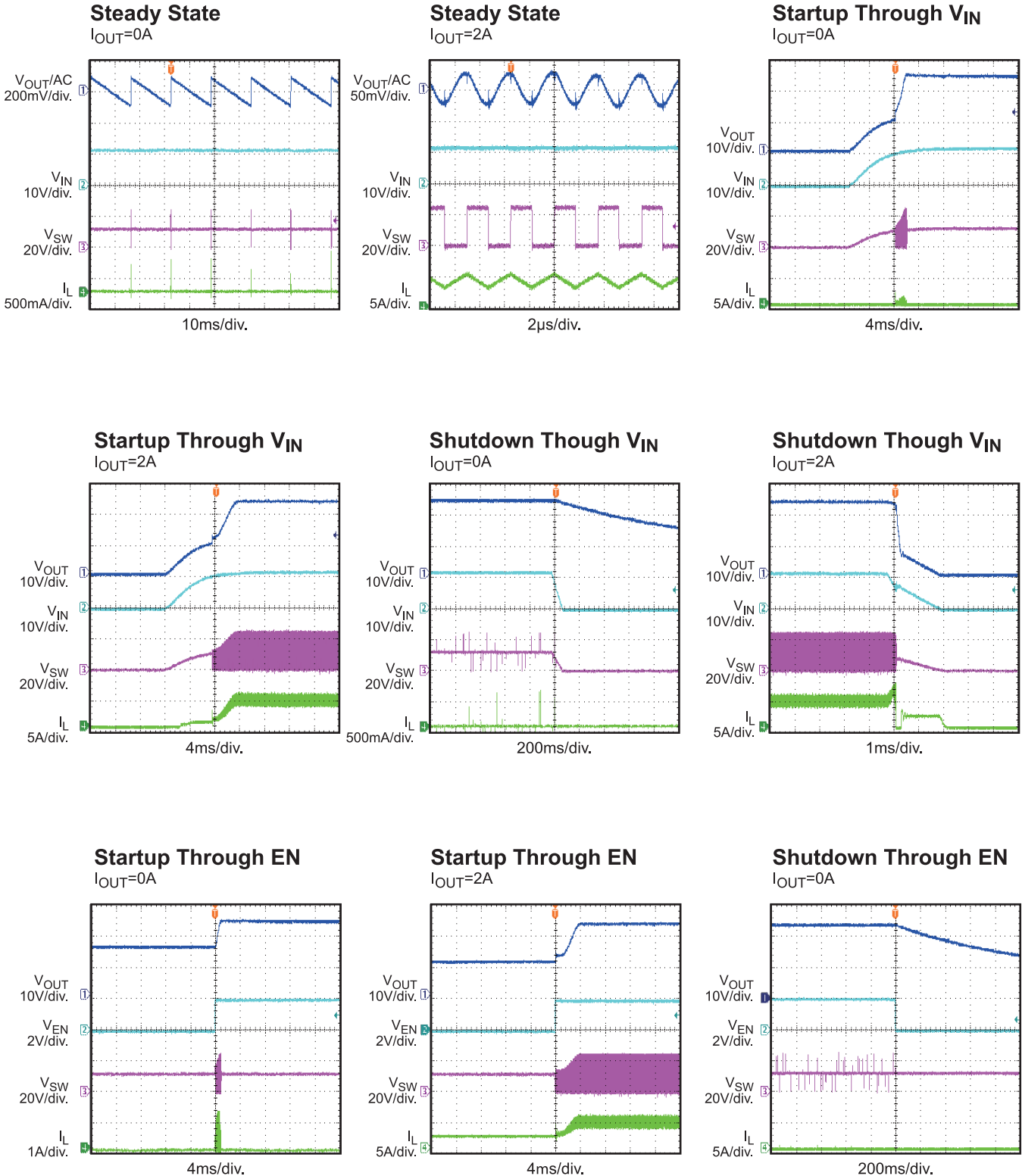

### EVB TEST RESULTS *(continued)*

Performance waveforms are tested on the evaluation board.

$V_{IN}=12V$ ,  $V_{OUT}=24V$ ,  $I_{OUT}=2A$ ,  $T_A=25^{\circ}C$ , unless otherwise noted.

#### Shutdown Through EN

$I_{OUT}=2A$

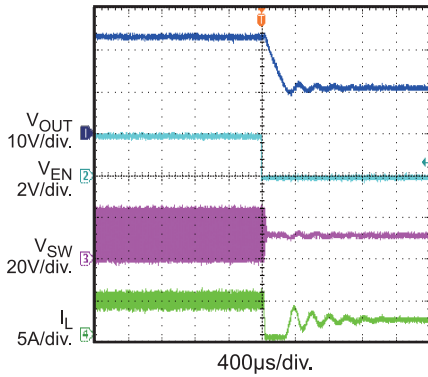

#### Load Transient

$I_{OUT}=1A \rightarrow 2A$ ,  $I_{RAMP}=25mA/\mu s$

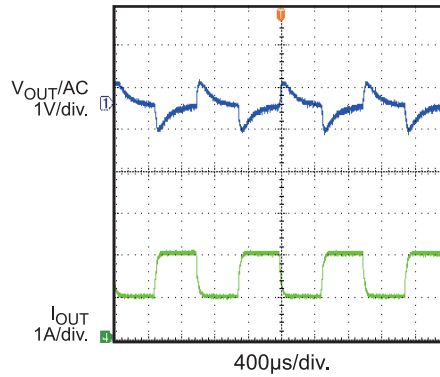

**PRINTED CIRCUIT BOARD LAYOUT**

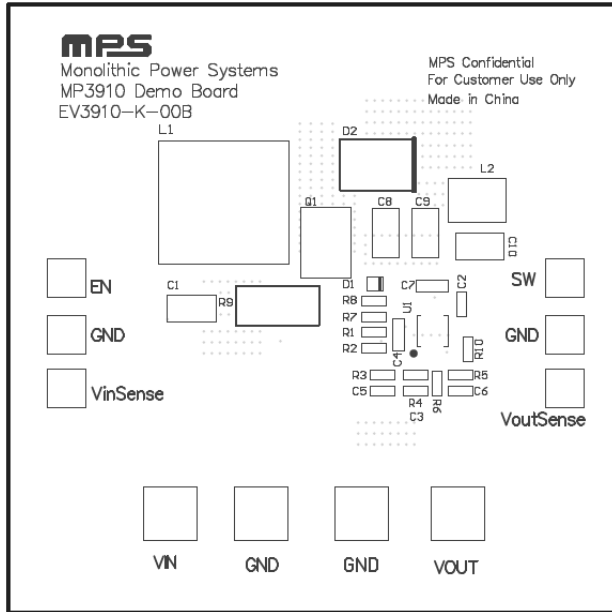

**Figure 1: Top Silk Layer**

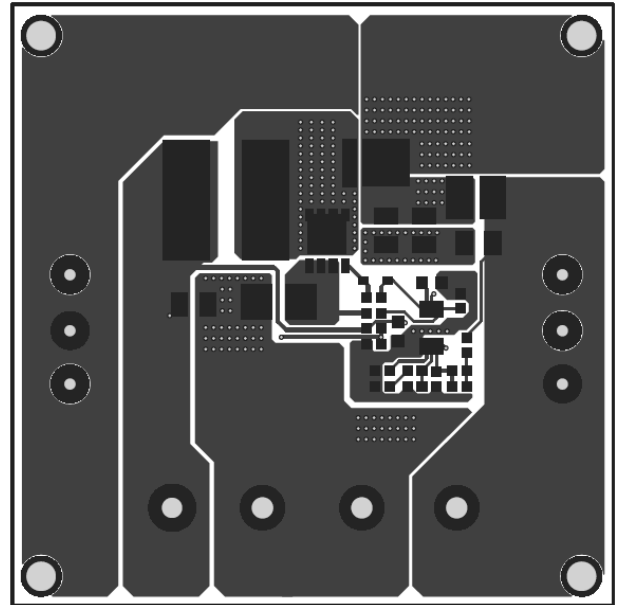

**Figure 2: Top Layer**

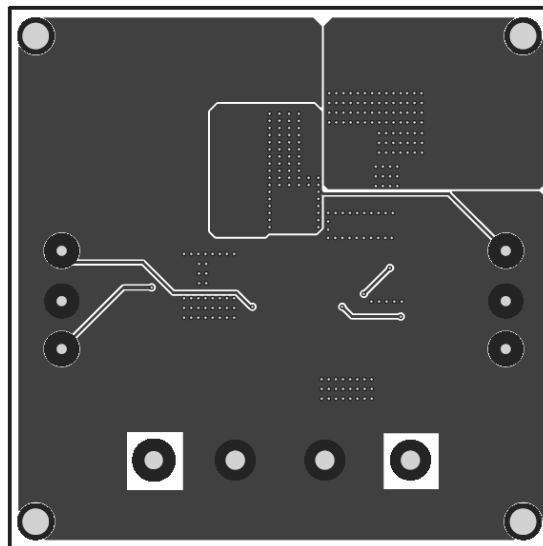

**Figure 3: Bottom Layer**

## QUICK START GUIDE

1. Connect the positive and negative terminals of the load to the VOUT and GND pins respectively.
2. Preset the power supply output between 10V and 20V, and then turn off the power supply.
3. Connect the positive and negative terminals of the power supply output to the VIN and GND pins, respectively.
4. Turn the power supply on. The EV3910-K-00B will automatically startup.
5. To use the Enable function, apply a digital input to the EN pin. Drive EN higher than 2V to turn on the regulator or less than 1V to turn it off.

**NOTICE:** The information in this document is subject to change without notice. Please contact MPS for current specifications. Users should warrant and guarantee that third party Intellectual Property rights are not infringed upon when integrating MPS products into any application. MPS will not assume any legal responsibility for any said applications.