



The Future of Analog IC Technology®

EV3908DK-00J

High Efficiency Isolated Active Clamp Forward EV Board

DESCRIPTION

The EV3908DK-00J is an evaluation board for the MP3908DK. It is configured to provide a regulated 3.3V output at up to 20A load current from a 36V-75V input. The output is adjustable by changing feedback resistors on the evaluation board.

MP3908DK features a synchronous gate output which enables high efficiency design by drive the clamp MOSFET.

ELECTRICAL SPECIFICATIONS

Parameter	Symbol	Value	Units
Input voltage	V_{IN}	36–75	V
Input current	I_{IN}	0–2	A
Output voltage	V_O	3.3	V
Output Current	I_O	20	A

FEATURES

- Isolated high efficiency 66W design
- Current Mode Control
- Cycle-by-Cycle Current Limiting
- 250kHz Constant Frequency Operation

APPLICATIONS

- Power over Ethernet (PoE)
- TV CCFL Power Generation
- Telecom Isolated Power
- Brick Modules

"MPS" and "The Future of Analog IC Technology" are Registered Trademarks of Monolithic Power Systems, Inc.

EV3908DK-00J EVALUATION BOARD

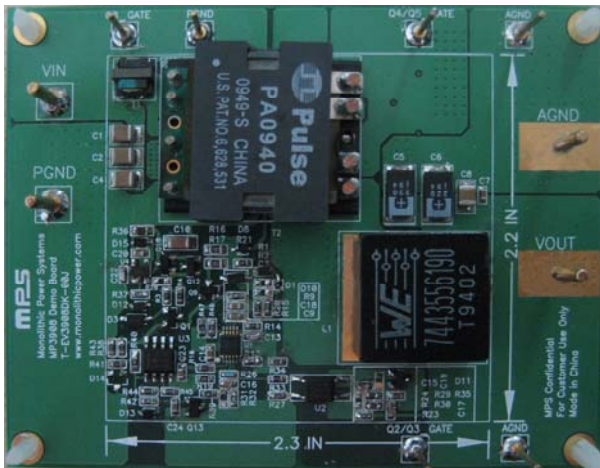

(L x W x H) 3.6" x 2.8" x 0.6"
9.1cm x 7.1cm x 1.4cm

Board Number	MPS IC Number
EV3908DK-00J	MP3908DK

Efficiency vs. Output Current

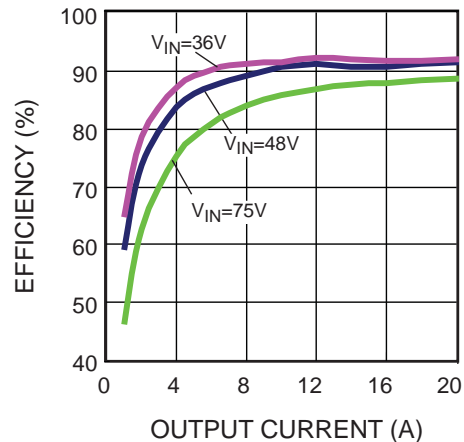

EVALUATION BOARD SCHEMATIC

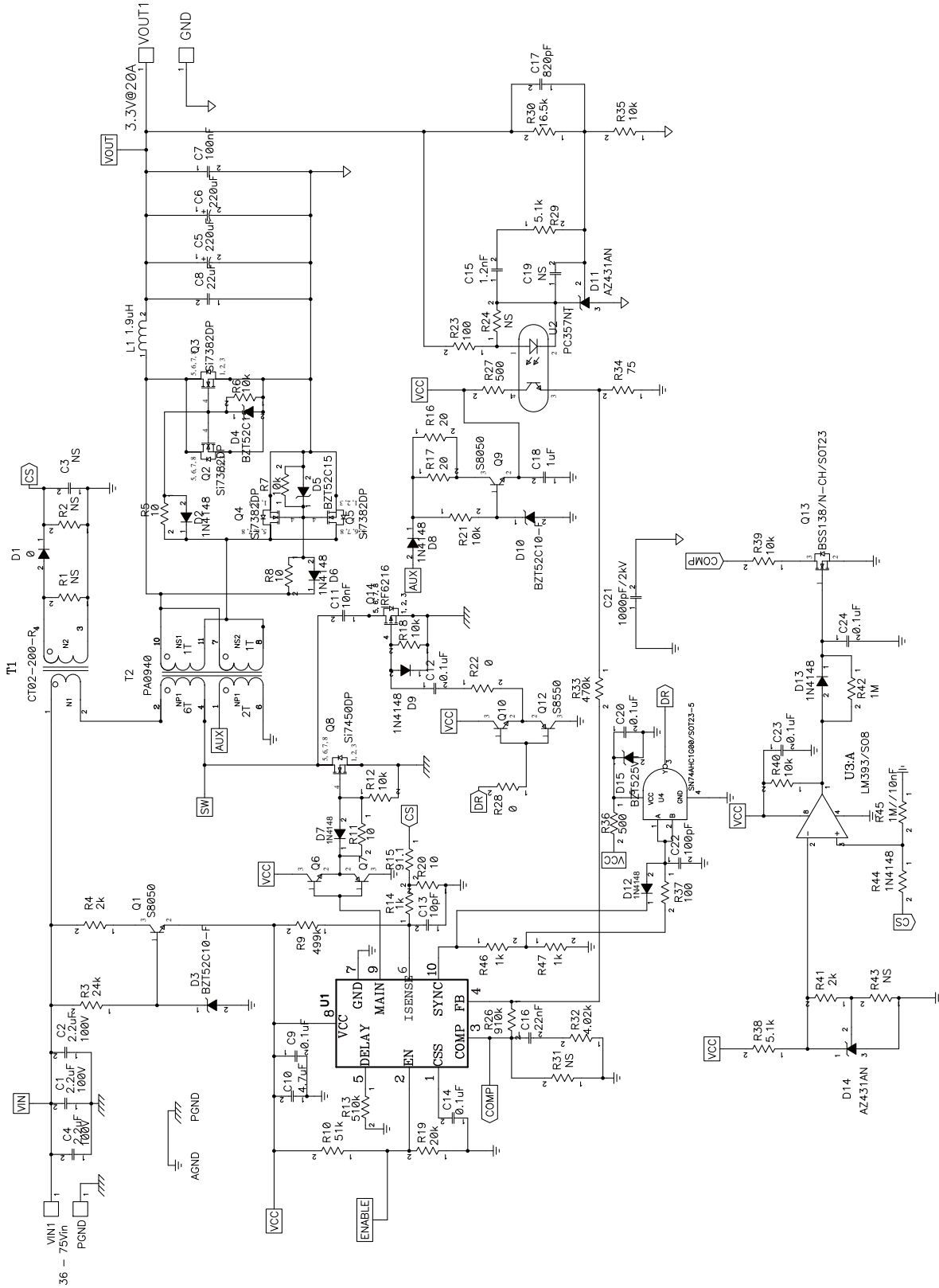

EV3908DK-00J BILL OF MATERIALS

Qty	Ref	Value	Description	Package	Manufacturer	Manufacturer P/N
3	C1,C2,C4	2.2uF	Ceramic Cap. 100V X7R	CAP1210	Murata	GRM32ER72A225KA352
2	C5,C6	220uF	Poscap, 6.3V	Poscap	SANYO	6TPE220M
7	C7,C9,C12,C14,C20,C23,C24	0.1uF	Ceramic Cap. 25V X7R	CAP0603	TDK	C1608X7R1E104K
1	C8	22uF	Ceramic Cap. 6.3V X5R	CAP1210	TDK	C3216X5R0J226M
1	C10	4.7uF	Ceramic Cap. 25V X7R	CAP1206	Murata	GRM31CR71E475KA88L
1	C11	10nF	Ceramic Cap. 250V X7R	CAP0805	TDK	C2012X7R2E103K
1	C13	10pF	Ceramic Cap. 50V X7R	CAP0603	TDK	C1608X7R1H101K
1	C16	22nF	Ceramic Cap. 50V X7R	CAP0603	TDK	C1608X7R1H223K
1	C19	NS		CAP0603		
1	C15	1.2nF	Ceramic Cap. 50V X7R	CAP0603	TDK	C1608X7R1H122K
1	C17	820pF	Ceramic Cap. 50V X7R	CAP0603	TDK	C1608X7R1H822K
1	C18	1uF	Ceramic Cap. 16V X7R	CAP0603	TDK	C1608X7R1C105K
1	C21	1000pF	Ceramic Cap. 2000V X7R	CAP1808	TDK	C4520X7R3D102K
1	C22	100pF	Ceramic Cap. 50V X7R	CAP0603	TDK	C1608X7R1H102K
9	R44,D2,D6,D7,D8,D9,D12,D13,D18	1N4148	Switching Diode 75V 250mW	SOD-323	Diodes Inc	1N4148WS-7
2	D3,D10	10V	DIODE ZENER 10V	SOD-123	Diodes Inc	BZT52C10V-F
1	D4	18V	DIODE ZENER 18V	SOD-123	Diodes Inc	BZT52C18V-F
1	D5	12V	DIODE ZENER 12V	SOD-323	Diodes Inc	BZT52C12S
1	D15	5.1V	DIODE ZENER 5.1V	SOD323	Diodes Inc	BZT52C5V1S
2	D11,D14	AZ431AN	REG VLT ADJ 1.24V	SOT-23	Zetex Inc	AZ431AN
4	Q1,Q6,Q9,Q10	NPN	Transistor NPN 40V 350mA	SOT-23	Fairchild	MMBT3904FSCT
2	Q7,Q12	PNP	Transistor PNP 40V 350mA	SOT-23	Fairchild	MMBT3906FSCT
4	Q2,Q3,Q4,Q5	Si7382DP	N-CH MOSFET 30V 24A	PowerPAK So-8	Vishay	Si7382DP
1	Q8	Si7450DP	N-CH MOSFET 200V 5.3A	PowerPAK So-8	Vishay	Si7450DP
2	Q13	AM2336N	N-CH MOSFET 30V 18.3A	SOT-23	Analog power	AM2336N
1	Q14	Si4409DY	P-CH MOSFET -150V 1.3A	SO-8	Vishay	Si4409DY
1	R37	100	Film Resistor 5%	RES0603	Yageo	RC0603JR-07101RL
1	R3	24k	Film Resistor 5%	RES0603	LIZ	CR0603JA0243G
1	R4	2k	Film Resistor 5%	RES0603	LIZ	CR0603JA0202G
4	R5,R11,R8,R28	10	Film Resistor 5%	RES0805		CR05T05NJ10R

EV3908DK-00J BILL OF MATERIALS (continued)

Qty	Ref	Value	Description	Package	Manufacturer	Manufacturer P/N
7	R6,R7,R12,R18,R21,R39,R40	10k	Film Resistor 5%	RES0603	Yageo	RC0603JR-0710KL
1	R35	10k	Strip Resistor 1%	RES0603	Yageo	RC0603FR-0710KL
1	R9	499k	Strip Resistor 1%	RES0603	Yageo	RC0603FR-07499KL
1	R10	51k	Strip Resistor 1%	RES0603	Yageo	RC0603FR-0751KL
1	R13	510k	Strip Resistor 1%	RES0603	Yageo	RC0603FR-07510KL
1	R14	1k	Film Resistor 5%	RES0603	Yageo	RC0603JR-071KL
1	R15	91	Strip Resistor 1%	RES0603	Yageo	RC0603JR-07137RL
2	R16,R17	100	Film Resistor 5%	RES0805	Yageo	RC0805JR-07100RL
1	R19	20k	Strip Resistor 1%	RES0603	Yageo	RC0603FR-0720KL
1	R20	10	Strip Resistor 1%	RES0603	Yageo	RC0603FR-0710RL
2	R23,R37	102	Film Resistor 1%	RES0603	Yageo	RC0603FR-07102RL
1	R26	910k	Film Resistor 1%	RES0603	Yageo	RC0603FR-07910KL
1	R27	499	Film Resistor 1%	RES0603	Yageo	RC0603FR-07499RL
1	R2,R22,D1	0	Film Resistor 5%	RES0603	Yageo	RC0603JR-070RL
1	R30	16.5k	Strip Resistor 1%	RES0603	Yageo	RC0603FR-0716K5L
3	R24,R31,R43	NS		RES0603		
1	R32	4.02k	Strip Resistor 1%	RES0603	Yageo	RC0603FR-074K02L
1	R33	470k	Strip Resistor 1%	RES0603	Yageo	RC0603FR-07470KL
1	R34	75	Strip Resistor 1%	RES0603	Yageo	RC0603FR-0775RL
1	R36	510	Film Resistor 5%	RES0805	Yageo	RC0805JR-07510RL
2	R29,R38	5.1k	Film Resistor 5%	RES0603	Yageo	RC0805JR-075RL
1	R41	2k	Strip Resistor 1%	RES0603	Yageo	RC0603FR-072KL
1	R45	1M//1nF	Ceramic Cap. 50V X7R	RES0603		C1608X7R1H103K
2	R42	1M	Film Resistor 5%	RES0603		
1	T1		Current sense			CT02-200-R
1	U1	MP3908DK	ACF	MSOP8	MPS	MP3908DK
1	U2	PC357NT	PHOTOCOUP	SMD	SHARP	PC357NT
1	U3	LM393	Comparator	SO-8	TI	LM393
1	U4	SN74AHC1G00	Nor	SOT-23-5	TI	SN74AHC1G00
1	T2	PA0940	TRANSFORMER		Pulse	
1	L1	1.9uH		SMD	Würth	7443556190

PRINTED CIRCUIT BOARD LAYOUT

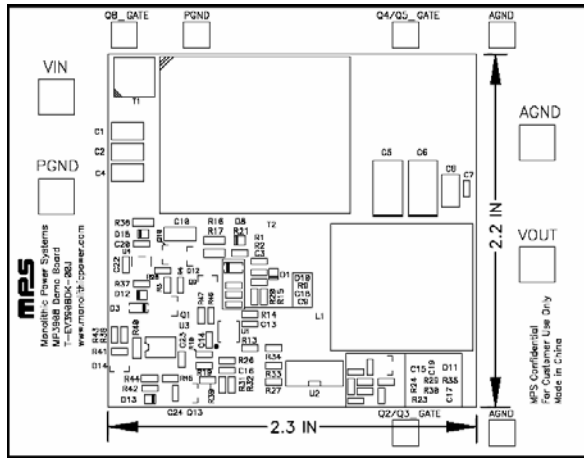

Figure 1—Top Silk Layer

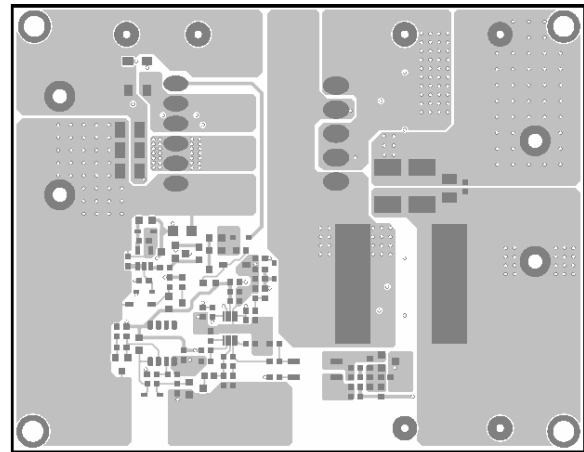

Figure 2—Top Layer

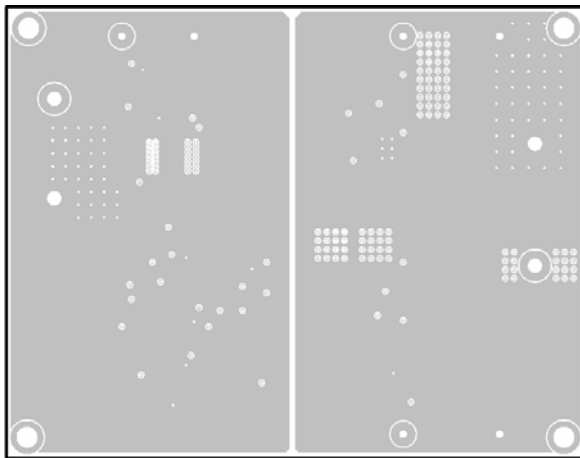

Figure 3—Inner Layer 1

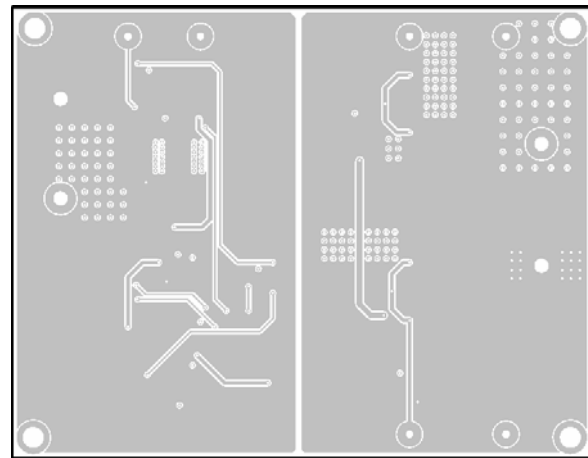

Figure 4—Inner Layer 2

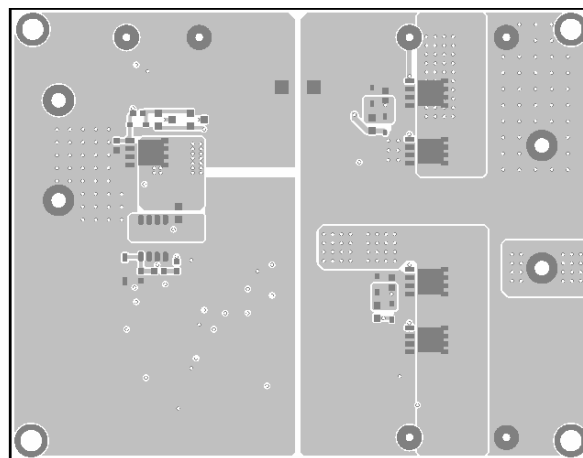

Figure 5—Bottom Layer

QUICK START GUIDE

1. Connect the positive and negative terminals of the load to VOUT and GND pins, respectively.
2. Preset the power supply output to 36V – 75V and turn off the power supply.
3. Connect the positive and negative terminals of the power supply output to the VIN and GND pins, respectively.
4. Turn the power supply on. The board will automatically startup.

NOTICE: The information in this document is subject to change without notice. Users should warrant and guarantee that third party Intellectual Property rights are not infringed upon when integrating MPS products into any application. MPS will not assume any legal responsibility for any said applications.