



EV3320B-Q-00A

4-Channel, Synchronous Boost RGB LED Driver with I²C Interface Evaluation Board

DESCRIPTION

The EV3320B-Q-00A is an evaluation board designed to demonstrate the capabilities of the MP3320B, a 4-channel, synchronous boost, RGB LED driver that operates across a wide 2V to 5.5V input voltage (V_{IN}) range. The maximum current per channel is 102mA, and the maximum output voltage (V_{OUT}) is 5.4V.

The I²C interface supports 16 different I²C addresses, which can be configured by an external resistor. Each channel can be enabled or disabled via the I²C.

The MP3320B employs separate 10-bit

pulse-width modulation (PWM) dimming and 8-bit analog dimming for each LED channel. The device also integrates a phase-shift function to reduce inrush current and audible noise during PWM dimming.

Full protection features include open LED protection, short LED protection, over-voltage protection (OVP), and over-temperature protection (OTP).

The MP3320B is available in a QFN-14 (2mmx2mm) package. The EV3320B-Q-00A is a fully assembled evaluation board.

PERFORMANCE SUMMARY

Specifications are at $T_A = 25^\circ\text{C}$, unless otherwise noted.

Parameters	Conditions	Value
Input voltage (V_{IN}) range		2V to 5.5V
Maximum output voltage (V_{OUT})	Over-voltage protection (OVP) threshold is typically 5.4V	5.4V
LED strings	Each LED channel can be enabled or disabled via the I ² C interface	4 strings
Maximum LED current (I_{LED})	ICHx[7:0] = FFh (x = 1, 2, 3, or 4)	102mA/string

EV3320B-Q-00A EVALUATION BOARD



LxWxH (6.35cmx6.35cmx2cm)

Board Number	MPS IC Number
EV3320B-Q-00A	MP3320BGG

QUICK START GUIDE

1. Connect the RGBW LED anodes to VOUT or VDD.
2. Connect the DC power supply terminals to:
 - a. Positive (+): VIN
 - b. Negative (-): GND
3. Connect the evaluation board's SCL, SDA, and GND pins to the I²C kit's SCL, SDA, and GND pins, respectively.
4. Configure the registers via the I²C interface. ⁽¹⁾

Notes:

- 1) The MP3320B GUI can be downloaded from the MPS website.

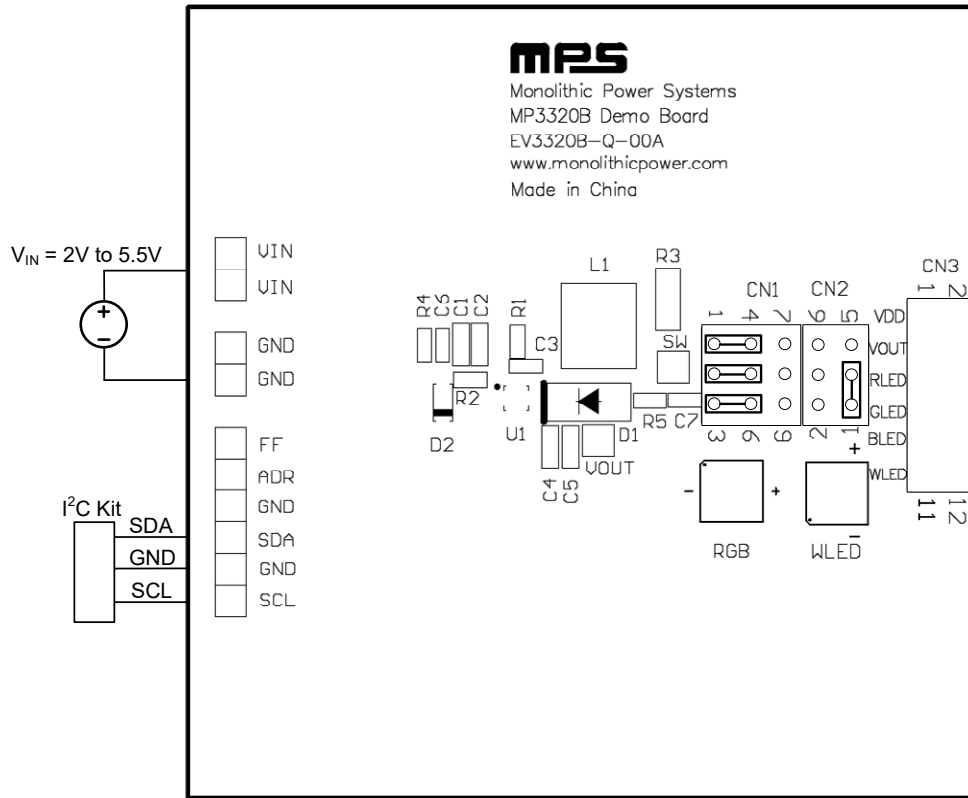

Figure 1: Measurement Equipment Set-Up (RGBW LED Anodes Are Connected to VOUT)

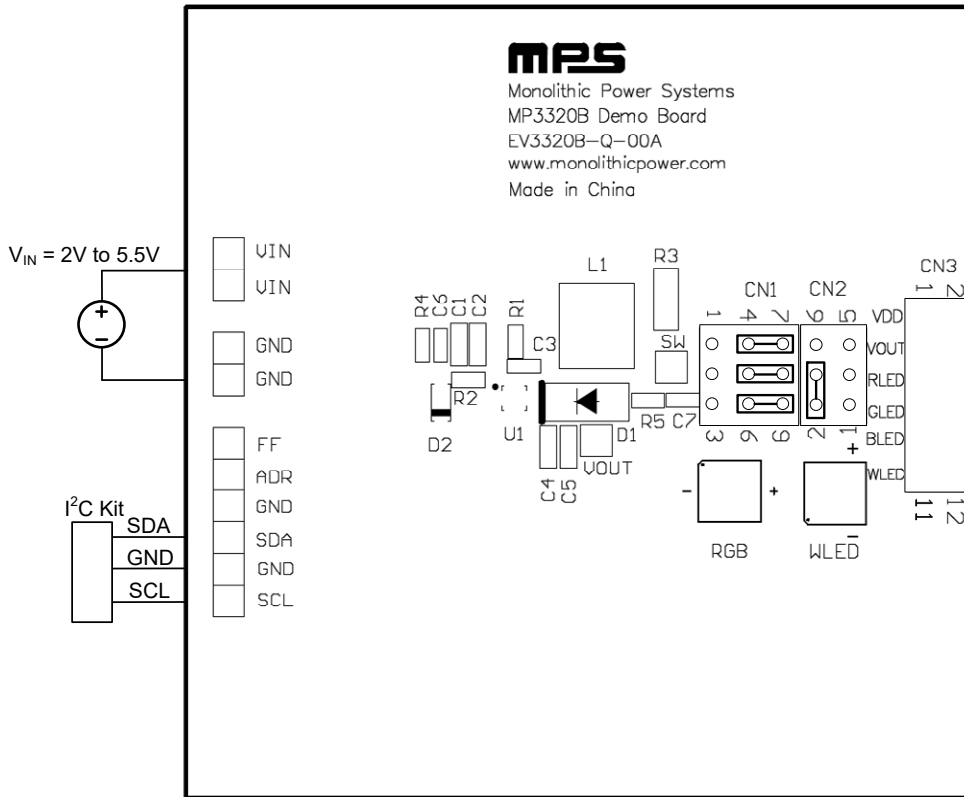
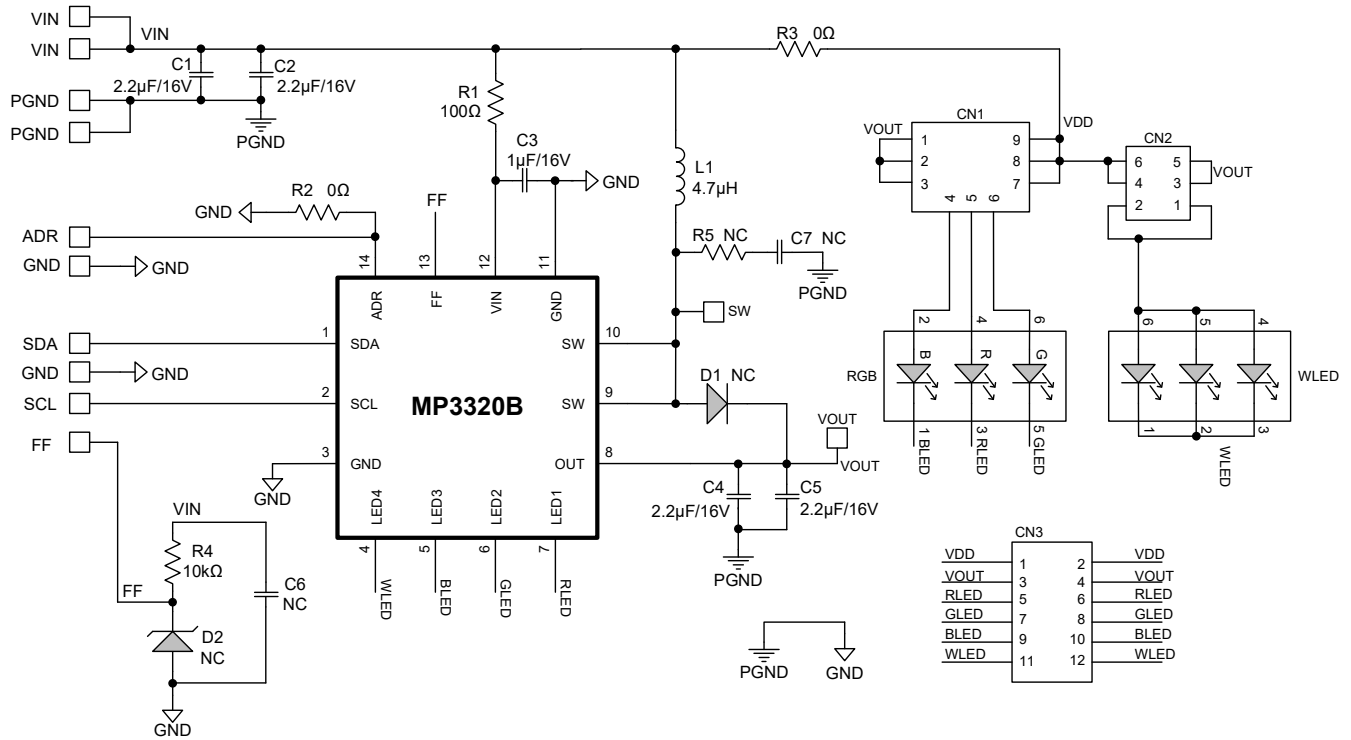

Figure 2: Measurement Equipment Set-Up (RGBW LED Anodes Are Connected to VDD)

EVALUATION BOARD SCHEMATIC

Figure 3: Evaluation Board Schematic

EV3320B-Q-00A BILL OF MATERIALS

Qty	Ref	Value	Description	Package	Manufacturer	Manufacturer PN
4	C1, C2, C4, C5	2.2μF	Ceramic capacitor, 16V, X7R	0805	Murata	GRM21BR71C225KA12L
1	C3	1μF	Ceramic capacitor, 16V, X7R	0603	Würth	885012206052
2	C6, C7	NC		0603		
1	R1	100Ω	Film resistor, 1%	0603	Yageo	RC0603FR-07100RL
1	R2	0Ω	Film resistor, 1%	0603	Yageo	RC0603FR-070RL
1	R3	0Ω	Film resistor, 1%	1206	Yageo	RC1206FR-070RL
1	R4	10kΩ	Film resistor, 1%	0603	Yageo	RC0603FR-0710KL
1	R5	NC				
1	D1	NC				
1	D2	NC				
1	L1	4.7μH	Inductor, 4.7μH, 2.6A, 34mΩ	SMD	Murata	DG6028C-#1253AY-4R7M
1	RGB	RGB	RGB LED, SMD, 1.5W	SMD	Guangyuan	GL-5050RGB 1.5W
1	WLED	White	WLED, SMD	SMD	Guangyuan	GL-5050QWC
10	VIN~FF terminal	2.54mm	Connector, header, 180°	2.54mm	Any	
2	CN1, CN2	2.54mm	Connector, header	2.54mm	Any	
1	CN3	2.54mm	Connector, dual-header	2.54mm	Any	
1	U1	MP3320B	4-channel, synchronous boost RGB LED Driver with I ² C interface, R3	QFN-14 (2mmx2mm)	MPS	MP3320BGG

EVB TEST RESULTS

Performance waveforms are tested on the evaluation board. $V_{IN} = 3V$, RGBW LED load, 50mA/channel, adaptive mode, $f_{sw} = 1MHz$, $T_A = 25^{\circ}C$, unless otherwise noted.

Steady State

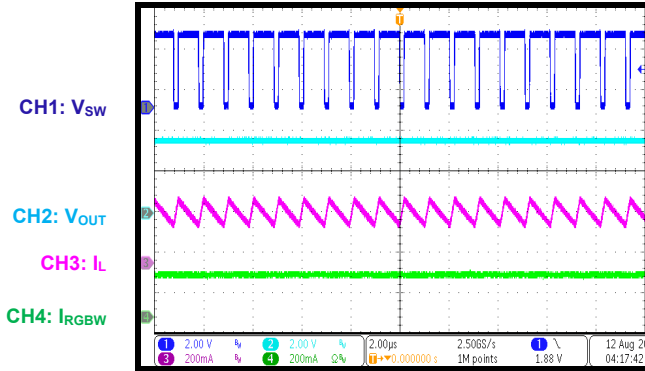

Steady State

CV mode, $V_{OUT} = 4.5V$

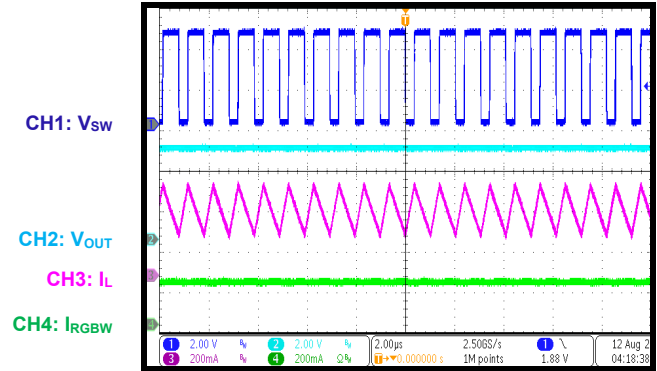

Start-Up through EN

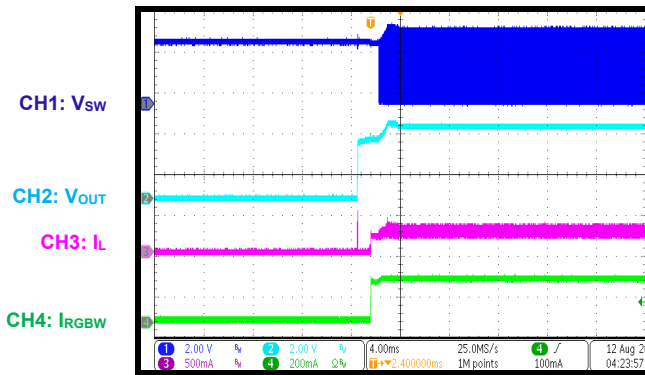

Start-Up through EN (Channels 1~4)

Enables channels 1~4 in sequence

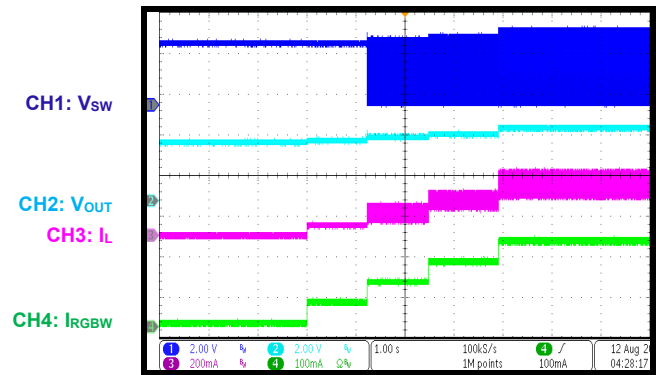

PWM Dimming

$f_{PWM} = 244Hz$, $D_{PWM} = 50\%$

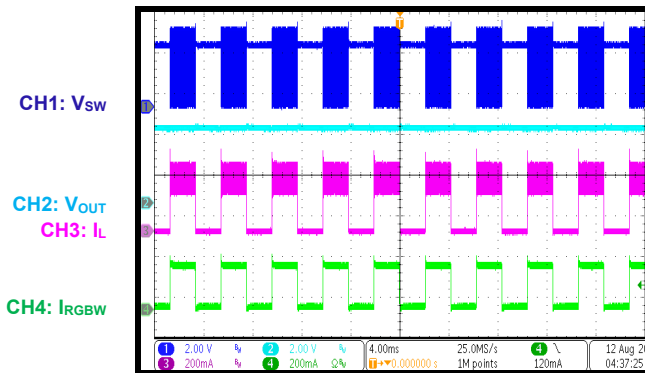

PWM Dimming with Phase Shift

$f_{PWM} = 244Hz$, $D_{PWM} = 10\%$, 90° phase shift

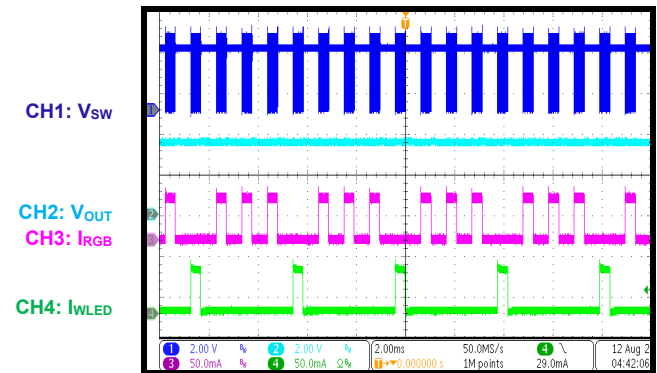

EVB TEST RESULTS (continued)

Performance waveforms are tested on the evaluation board. $V_{IN} = 3V$, RGBW LED load, 50mA/channel, adaptive mode, $f_{sw} = 1MHz$, $T_A = 25^\circ C$, unless otherwise noted.

Blinking Mode

$f_{PWM} = 1.95kHz$, $D_{PWM} = 50\%$, all channels blinking ($f_{BLINK} = 0.5Hz$, $D_{BLINK} = 50\%$, IC continues to operate in blinking mode)

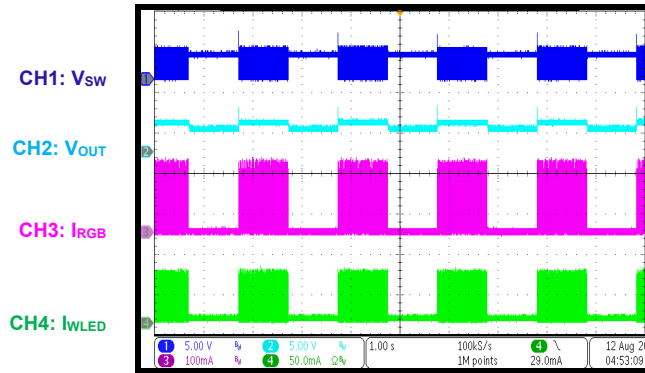

Breathing Light Mode

$t_{STEP_UP} = t_{STEP_DOWN} = 1ms/step$, $D_{PWM} = 100\%$, all channels blinking ($f_{BLINK} = 0.5Hz$, $D_{BLINK} = 50\%$, IC continues to operate in blinking mode)

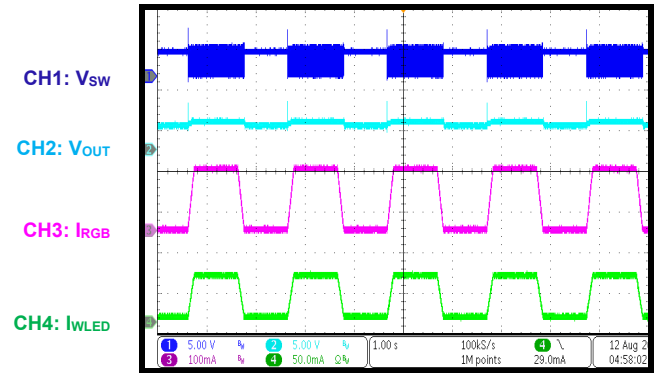

LED Open Protection

$OLP_MD[1:0] = 10b$, open RLED during normal operation

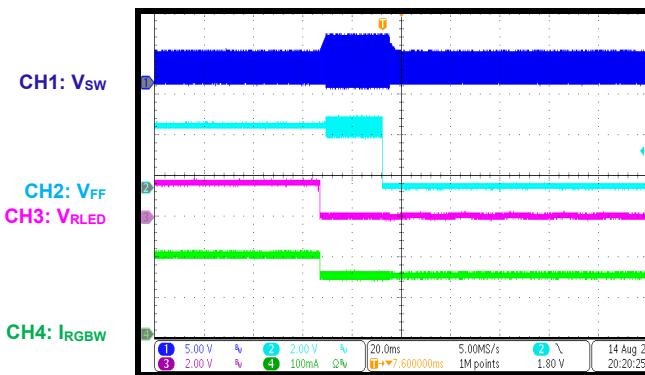

LED Short Protection

$SLP_MD[1:0] = 10b$, SLP threshold = 2.5V, short RLED during normal operation

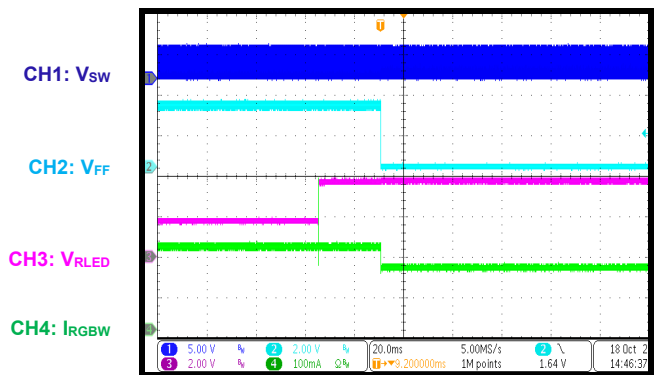

All LED Short Protection

SLP threshold = 2.5V, short RGBW LED, change $SLP_MD[1:0]$ from 00b to 10b

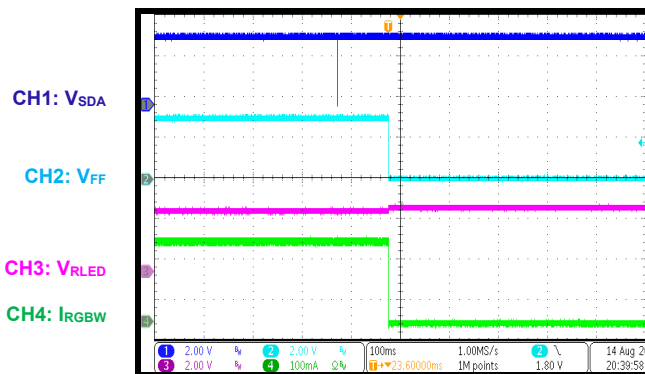

Over-Temperature Protection

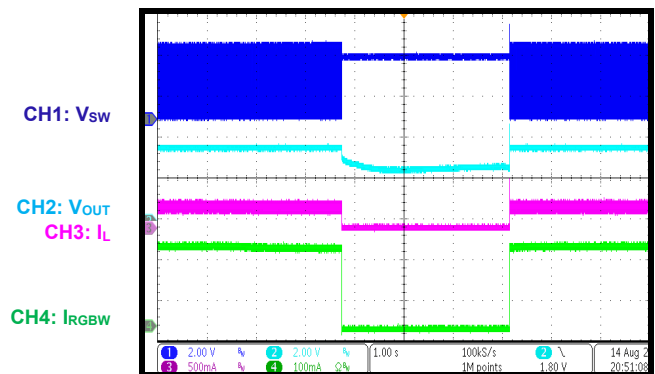

PCB LAYOUT

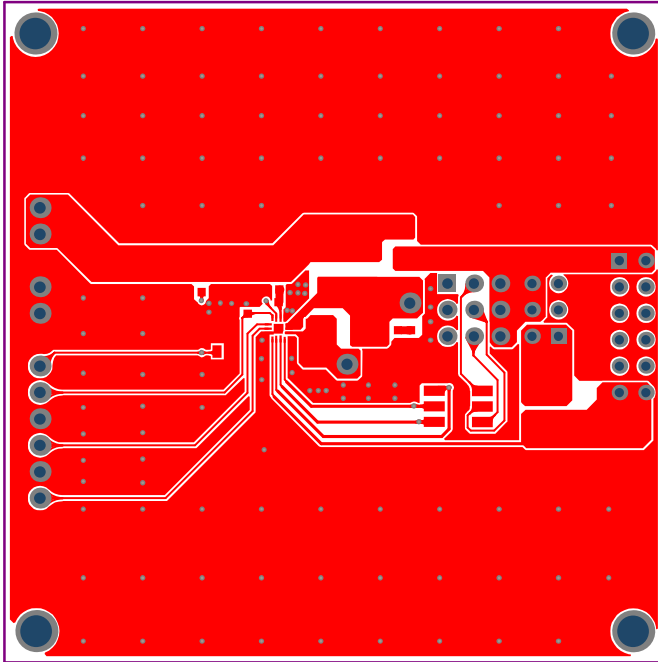

Figure 4: Top Layer

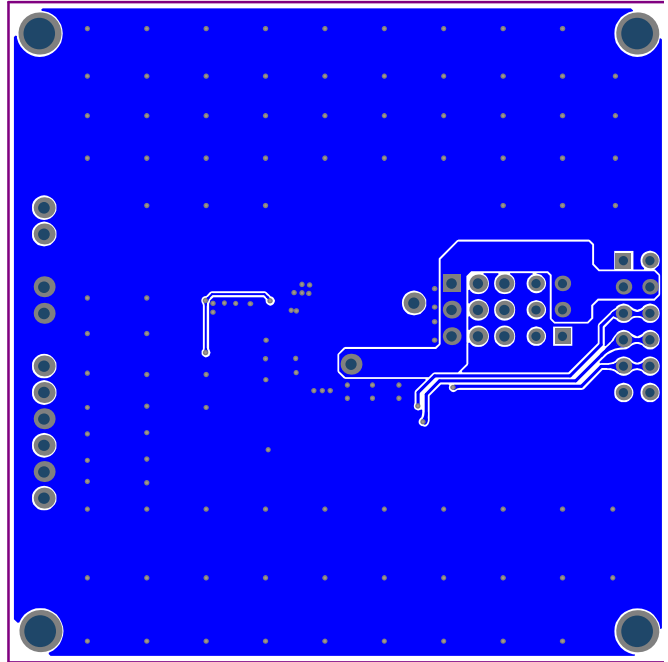

Figure 5: Bottom Layer



REVISION HISTORY

Revision #	Revision Date	Description	Pages Updated
1.0	3/6/2023	Initial Release	-

Notice: The information in this document is subject to change without notice. Please contact MPS for current specifications. Users should warrant and guarantee that third-party Intellectual Property rights are not infringed upon when integrating MPS products into any application. MPS will not assume any legal responsibility for any said applications.