



The Future of Analog IC Technology®

EV3313

3-Channel, Max 38V Output, Linear/Exponential, Analog Dimming, Step-Up WLED Driver with I²C

DESCRIPTION

The MP3313 is a step-up, white, LED converter. The MP3313 uses peak-current mode and a 3-channel current sink to regulate the LED current with up to 25mA on each channel (100mA at flash mode) with 2.7 - 5.5V input voltage.

The MP3313 integrates a 300mΩ, 42V MOSFET and supports selectable over-voltage protection (17/23/30/38V). The MP3313 can drive up to 10 LEDs in series for LCD panels greater than 5”.

The MP3313 achieves ultra-high resolution analog dimming by converting the pulse-width input signal or internal register code to an 11-bit brightness code. The MP3313 is designed with two types of LED current dimming mapping: linear and exponential mapping.

An auto-switching frequency function is integrated to optimize efficiency performance. Full protection features include LED open and short protection, cycle-by-cycle current-limit protection, and thermal shutdown.

The I²C interface can set the internal register to program the MP3313 for flexible applications, such as dimming mode, LED current slope, and protection threshold.

The MP3313 is available in a small WLCSP-12 (1.3mmx1.7mm) package.

ELECTRICAL SPECIFICATIONS

Parameter	Symbol	Value	Units
Input Voltage	V _{IN}	2.7-5.5	V
Output Voltage	V _{LED}	<38	V
LEDs #		3 string	
LED Current /string	I _{LED}	25	mA

FEATURES

- 2.7 - 5.5V Input Voltage
- 300mΩ, 42V Internal MOSFET
- 3-Channel Current Sink, Each Channel Enable/Disable Respectively
- LED Current up to 25mA in Backlighting Mode
- LED Current up to 100mA in Flash Mode
- 250μA - 25mA LED Current with ±3% Accuracy
- ±1% Typical Current Matching
- Linear or Exponential Analog Dimming
- 11-Bit Dimming Resolution
- Selectable Switching Frequency: 500kHz or 1MHz with Optional -12% Shift
- Auto-Switching Frequency (250kHz, 500kHz, 1MHz)
- High-Speed I²C Interface (1.2MHz)
- I²C Address External Selectable (A0 Pin)
- Internal Soft Start (SS) to Reduce Inrush Current
- Current-Limit Protection (0.75/1/1.25/1.5A)
- LED Open Protection (17/23/30/38V)
- LED Short Protection (2/3/5V)
- Available in a WLCSP-12 (1.3mmx1.7mm) Package

APPLICATIONS

- Smart Phones
- Tablets
- GPS Receivers
- LCD Video Displays with One-Cell Li-Ion Battery

All MPS parts are lead-free and adhere to the RoHS directive. For MPS green status, please visit MPS website under Products, Quality Assurance page.

“MPS” and “The Future of Analog IC Technology” are registered trademarks of Monolithic Power Systems, Inc.

EV3313-C-00A EVALUATION BOARD

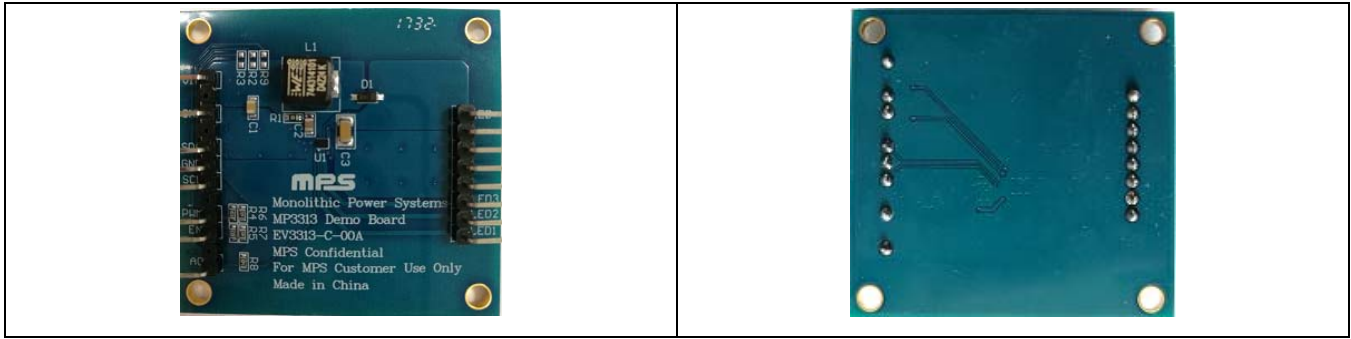

(L x W x H) 4.7cm x 4.9cm x 1.56cm

Board Number	MPS IC Number
EV3313-C-00A	MP3313GC

EVALUATION BOARD SCHEMATIC

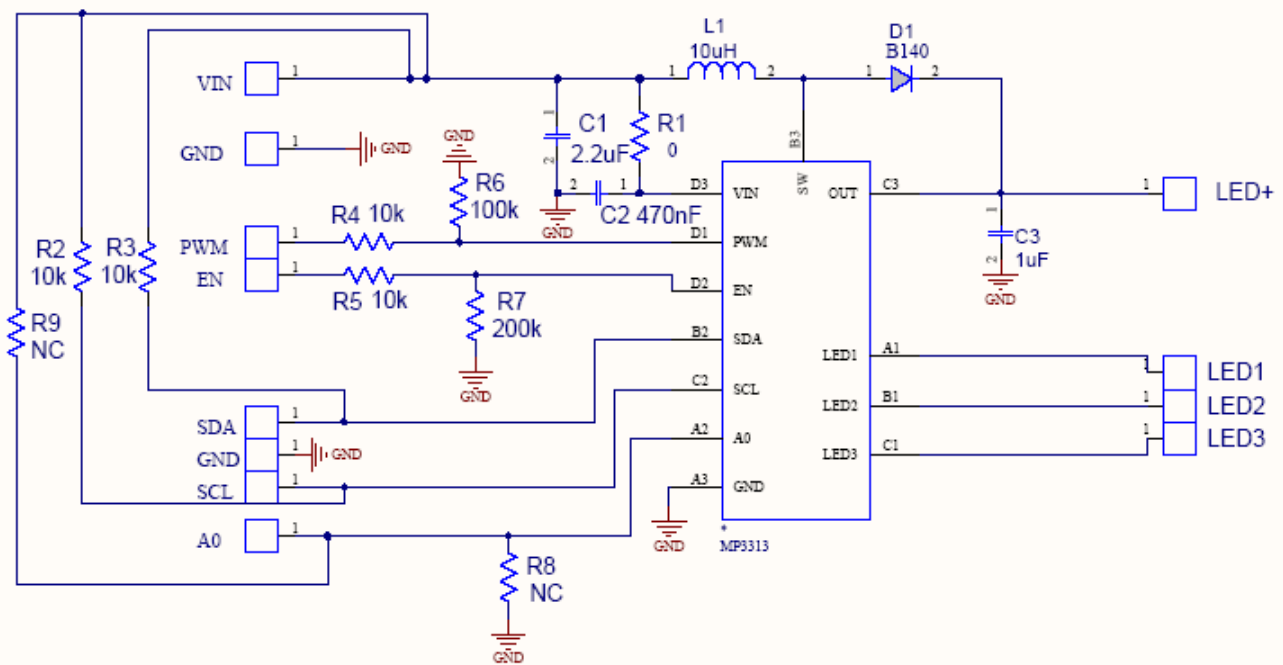

EV3313-C-00A BILL OF MATERIALS

Qty	Ref	Value	Description	Package	Manufacture	Manufacture_PN
1	C1	4.7uF	Ceramic Capacitor;16V;X5R;0805;	0805	muRata	GRM21BR61C475KA88L
1	C2	470nF	'Ceramic Capacitor;10V;X7R;0805;	0805	muRata	GRM31CR71C106KAC7L
1	C3	2.2uF	'Ceramic Capacitor;10V;X7R;1206;	1206	muRata	GJ8319R61H225K
1	L1	10uH	Inductor;10uH;65.6m; 2.47A	SMD	Cooper	DR73-100-R
1	D1	B140	Diode, B140, 1A, 40V	SMA		
1	R1	0Ω	Resistor;5%;;	0603	Yageo	RTT03000JTP
3	R2,R3,R9	NC	Resistor;5%;	0603	Yageo	
2	R4,R5	10kΩ	Resistor;5%;	0603	Yageo	RC0603JR-0710KL
2	R6,R7	200kΩ	Resistor;5%;	0603	Yageo	RC0603JR-07200KL
1	R8	100kΩ	Resistor;5%;	0603	Yageo	RC0603JR-07100KL
12	VIN, GND, PWM, EN, SDA, GND, SCL, A0, LED+, LED1, LED2, LED3		TP	90 度弯针, 1*40, 2.54mm		
1	MP3313		WLCSP12-1.3mm*1.7mm		MPS, R1	

EVB TEST RESULTS

Performance waveforms are tested on the evaluation board.

V_{IN} = 3.6V, 8*LEDs/string, I_{LED}/Ch = 20mA, L = 10μH, T_A = 25°C, unless otherwise noted.

LED Current for Each Channel with Register Code

Current Curve (Dimming by Code only)

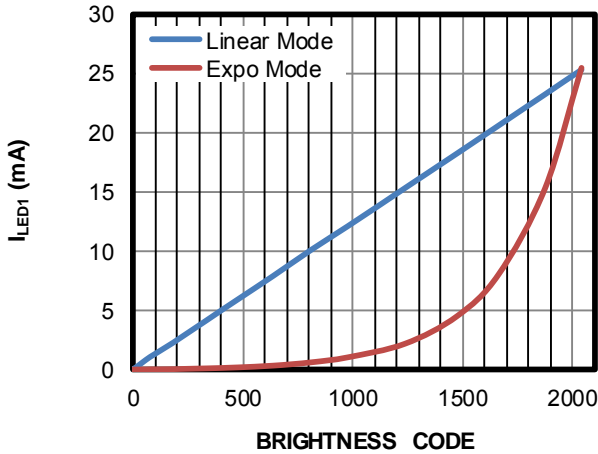

LED Current for Each Channel with PWM Input Duty

Current Curve (Dimming by PWM only)

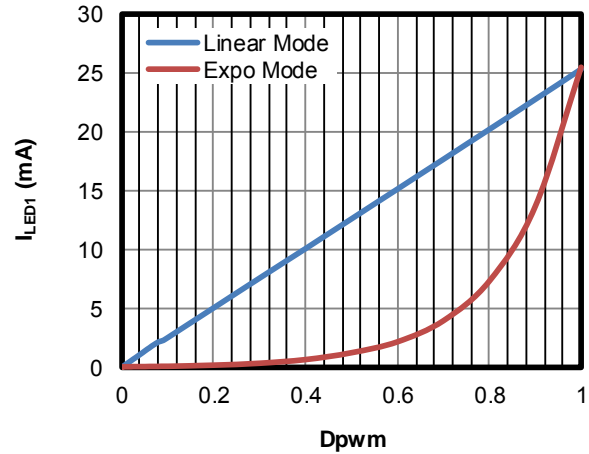

Efficiency Curve E-I_{OUT}

1MHz, 10μH, DCR = 49mΩ

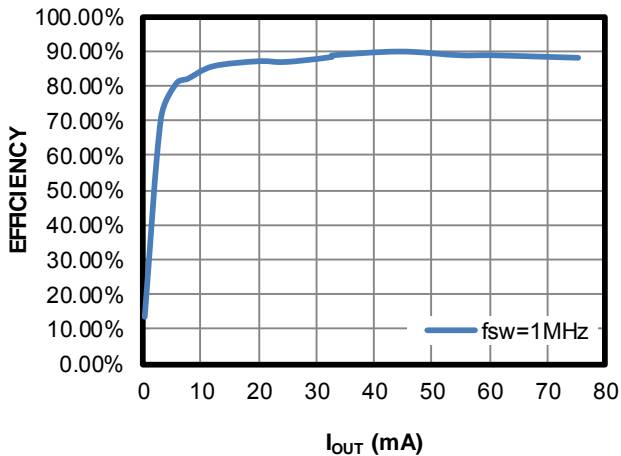

Efficiency Curve E-I_{OUT}

500kHz, 10μH, DCR = 49mΩ

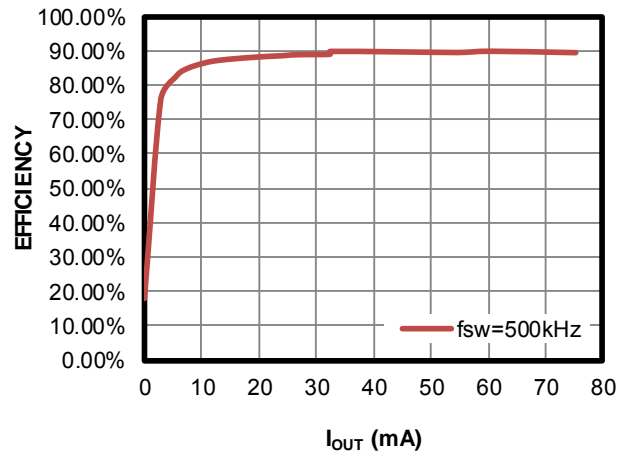

Efficiency Curve E-V_{IN}

10μH, DCR = 49mΩ

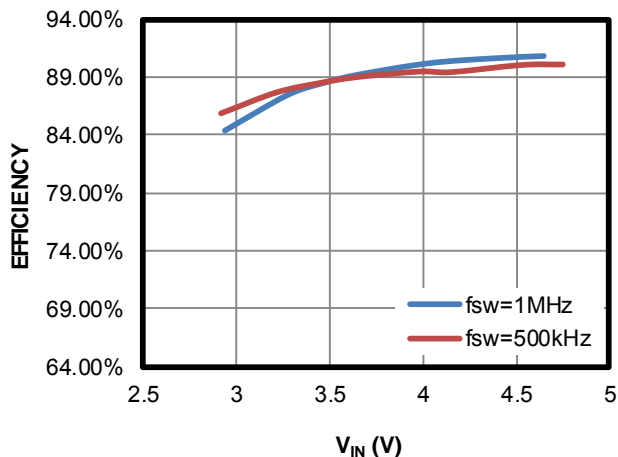

LEDx Voltage vs. LED Current

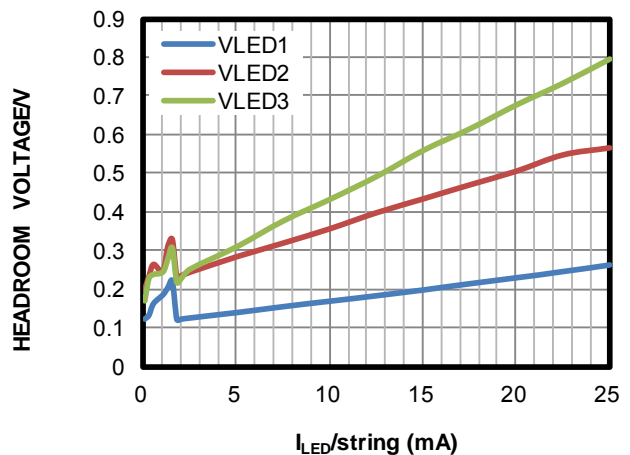

EVB TEST RESULTS *(continued)*

Performance waveforms are tested on the evaluation board.

VIN = 3.6V, 8*LEDs/string, I_{LED}/Ch = 20mA, L = 10μH, T_A = 25°C, unless otherwise noted.

Steady State

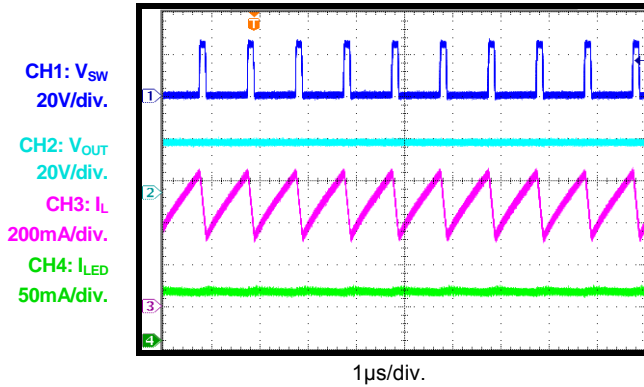

EN Power-On

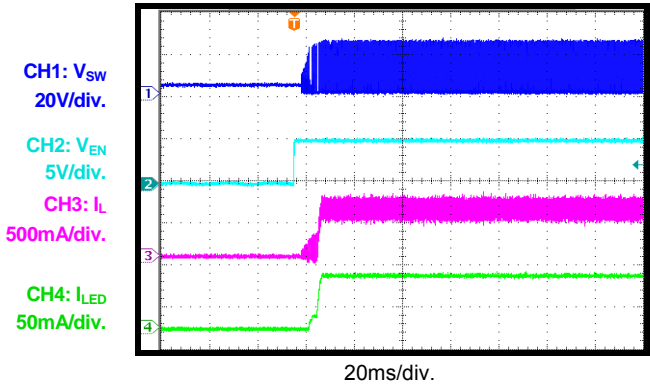

VIN Power On

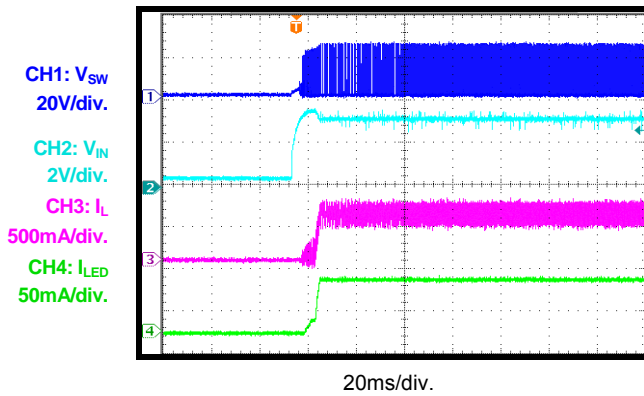

Flash Mode

Flash Time = 300ms, Flash Current = 40mA/ch

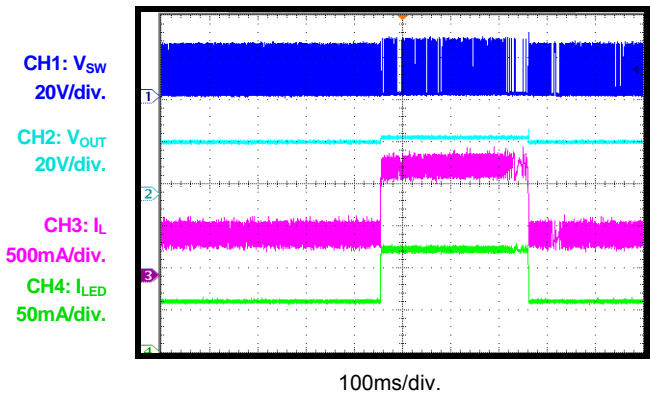

Short LED Protection (Mark Off)

Short one string

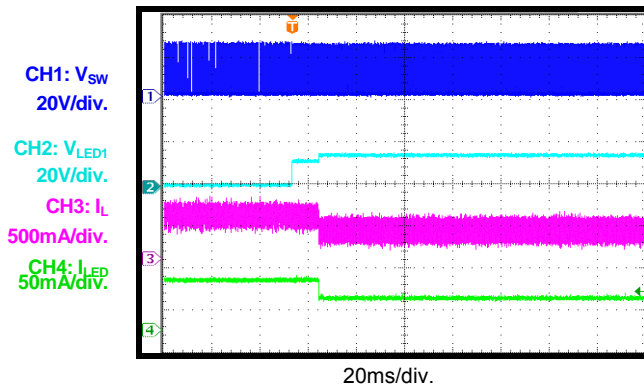

Short LED Protection (IC Latch Off)

Short LED1 String

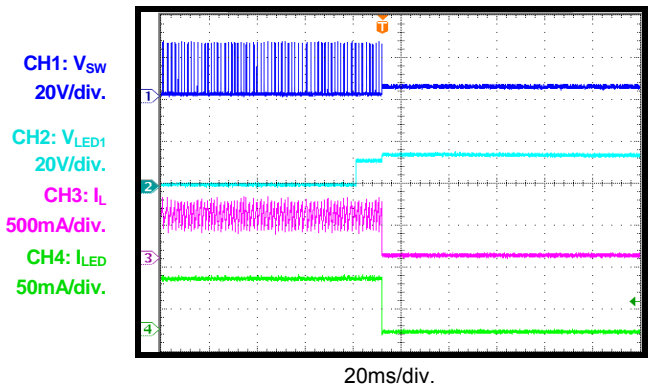

PRINTED CIRCUIT BOARD LAYOUT

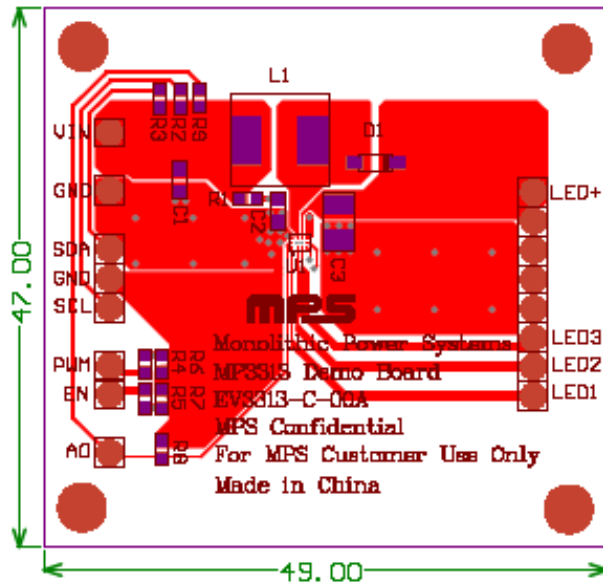

Figure 1—Top Layer

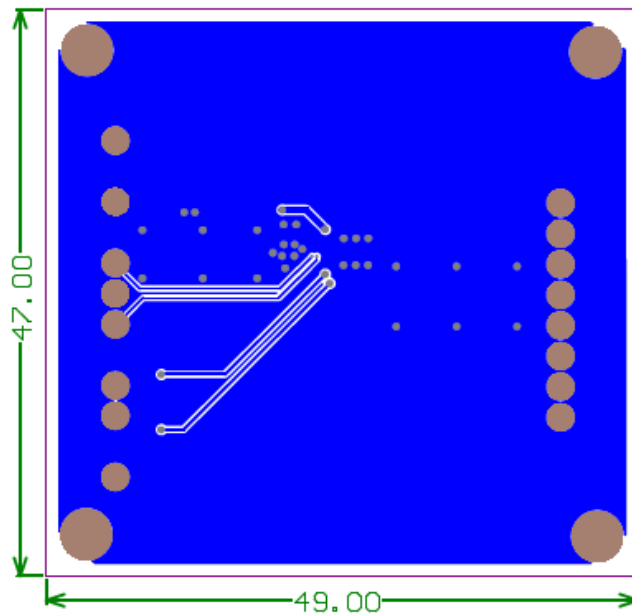

Figure 2—Bottom Layer

QUICK START GUIDE

1. Provide a voltage source ranges from 2.7-5.5V between VIN terminal and GND.on the EV board.
2. Connect the positive and negative terminals of the LED load (3 strings) to the LED+ and LED1~3 pins on the EV board, respectively.
3. Drive EN pin high logical to enable the MP3313.
4. 50Hz~50kHz PWM pulse is added to the PWM terminal. Choose a proper PWM frequency based on the sample frequency.
5. Please connect SCL, SDA and GND of EV board to SCL, SDA and GND of a programmable kit with I²C interface, respectively.
6. A0 pin is for I2C external address selectable(0x36 and 0x37)

When the resistor R8 is connected to GND by 100kΩ, the I2C address is 0x36.

When the resistor R9 is connected to Vin by 100kΩ, the I2C address is 0x37.

Below is the GUI of MP3313. It is easy that user can write or read the I2C data by the GUI.

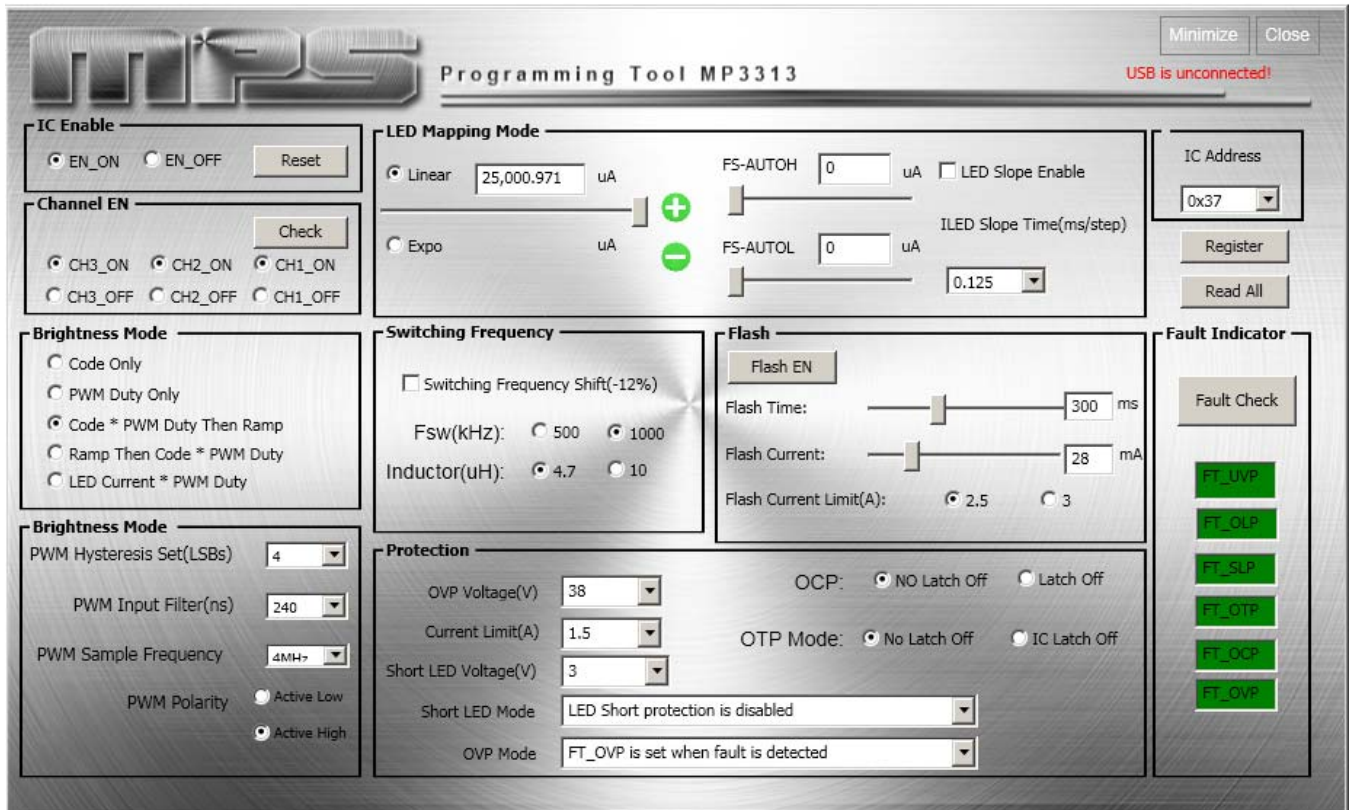

NOTICE: The information in this document is subject to change without notice. Please contact MPS for current specifications. Users should warrant and guarantee that third party Intellectual Property rights are not infringed upon when integrating MPS products into any application. MPS will not assume any legal responsibility for any said applications.