

### DESCRIPTION

The EV2908A-F-02A is an evaluation board for MP2908A/MPQ2908A, a high voltage, synchronous step-down switching regulator controller that can directly step-down voltages from up to 60V.

It uses PWM current control architecture with accurate cycle-by-cycle current limiting and is capable of driving dual N-channel MOSFETs.

Advanced asynchronous mode (AAM) enables non-synchronous operation to optimize light-load efficiency.

The operating frequency of the MP2908A/MPQ2908A can be programmed by an external resistor or synchronized to an external clock for noise-sensitive applications. Full protection features include precision output over-voltage protection (OVP), output over-current protection (OCP), and thermal shutdown.

The EV2908A-F-02A is assembled and tested with TSSOP20-EP package.

### ELECTRICAL SPECIFICATION

Parameter	Symbol	Value	Units
Input Voltage	$V_{IN}$	6-60	V
Output Voltage	$V_{OUT}$	5	V
Output Current	$I_{OUT}$	7	A

### FEATURES

- Wide 6V to 60V Operating Input Range
- Dual N-Channel MOSFET Driver
- 0.8V Voltage Reference with  $\pm 1.5\%$  Accuracy Over Temperature
- Low Dropout Operation: Maximum Duty Cycle at 99.5%
- Programmable Frequency Range: 100kHz - 1000kHz
- External Sync Clock Range: 100kHz-1000kHz
- 180° Out-of-Phase SYNCO
- Programmable Soft Start
- Power Good Output Voltage Monitor
- Selectable Cycle-by-Cycle Current Limit
- Output Over-Voltage Protection (OVP)
- Over-Current Protection (OCP)
- Internal LDO with External Power Supply Option
- Programmable CCM, AAM Mode

All MPS parts are lead-free and adhere to the RoHS directive. For MPS green status, please visit MPS website under Products, Quality Assurance page.

"MPS" and "The Future of Analog IC Technology", are Registered Trademarks of Monolithic Power Systems, Inc.

### EV2908A-F-02A EVALUATION BOARD



(L x W x H) 8.36cm x 8.36cm x 1.18cm

Board Number	MPS IC Number
EV2908A-F-02A	MPQ2908AGF

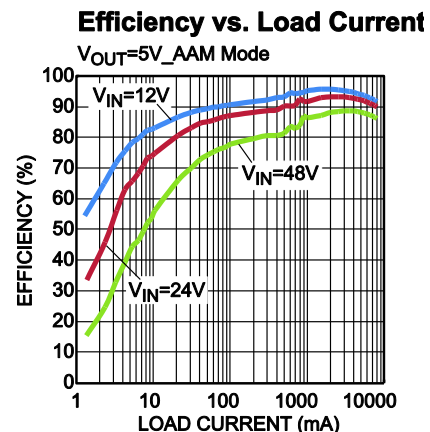

## EVALUATION BOARD SCHEMATIC

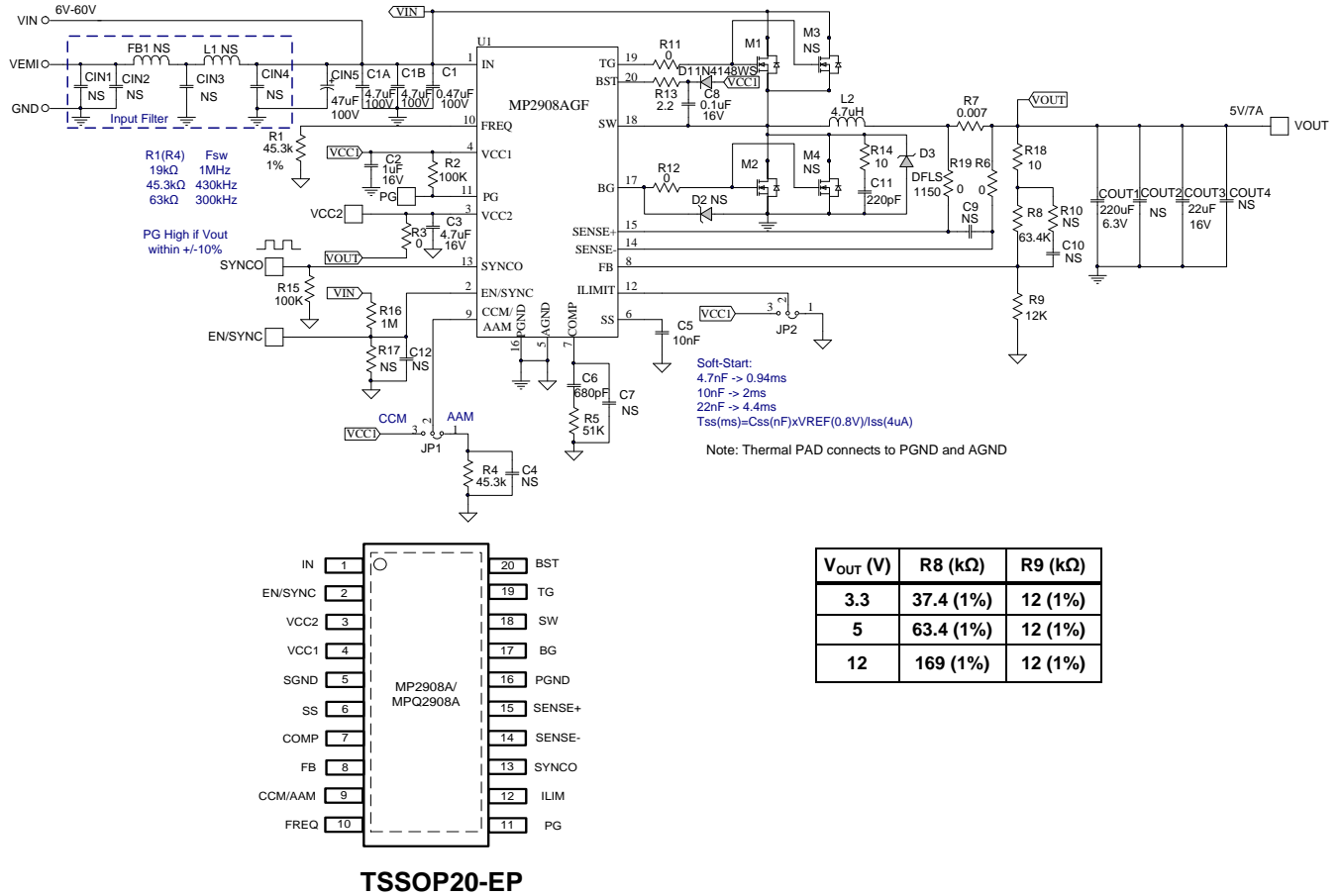

V <sub>OUT</sub> (V)	R8 (kΩ)	R9 (kΩ)
3.3	37.4 (1%)	12 (1%)
5	63.4 (1%)	12 (1%)
12	169 (1%)	12 (1%)

## EV2908A-F-02A BILL OF MATERIALS

Qty	Ref	Value	Description	Package	Manufacturer	Part Number
4	CIN1,CIN2, CIN3,CIN4	NS				
1	CIN5	47μF	Electrolytic Cap; 100V;10*10.5; 2000H;105°C	SMD	Jiang Hai	VZ2-100V47
2	C1A, C1B	4.7μF	Ceramic Cap; 100V;X7S	1210	TDK	C3225X7S2A475K
1	C1	0.47μF	Ceramic Cap; 100V;X7R	0805	muRata	GRM21BR72A474KA73L
1	C2	1μF	Ceramic Cap; 16V;X7R	0603	muRata	GRM188R71C105KA12D
1	C3	4.7μF	Ceramic Cap; 16V;X7R	0805	muRata	GRM21BR71C475KA73L
5	C4,C7,C9, C10,C12	NS				

**EV2908A-F-02A BILL OF MATERIALS (continued)**

Qty	Ref	Value	Description	Package	Manufacturer	Part Number
1	C5	10nF	Ceramic Cap; 50V;X7R	0603	muRata	GRM188R71H103KA01
1	C6	680pF	Ceramic Cap; 50V;X7R	0603	muRata	GRM188R71H681KA01D
1	C8	0.1µF	Ceramic Cap; 16V;X7R	0603	muRata	GRM188R71C104KA01D
1	C11	220pF	Ceramic Cap; 100V;X7R	0805	muRata	GRM21BR72A221KA01L
1	COU1	220µF	POSCAP;6.3V;	D2	SANYO	6TPE220MI
1	COU3	22µF	Ceramic Cap; 16V;X7R	1210	muRata	GRM32ER71C226KE79
2	COU2, COU4	NS				
1	D1	1N4148WS	Diode;75V;0.15A;	SOD-323	Diodes	1N4148WS-7-F
1	D2	NS				
1	D3	DFLS1150	Diode;150V;1A;		DIODES	DFLS1150
1	FB1	NS				
1	L1	NS				
1	L2	4.7µH	Inductor;4.7µH; 7.7mOhm;15A	SMD	Wurth	7443551470
2	M1, M2	SQJ850EP	N-Channel Mosfet; 60V;24A;0.023Ohm	PowerPA K SO-8L	Vishay	SQJ850EP
2	M3, M4	NS				
2	R1, R4	45.3k	Film Resistor;1%	0603	Yageo	RC0603FR-0745K3L
2	R2, R15	100k	Film Resistor;1%	0603	Yageo	RC0603FR-07100KL
5	R3,R6,R 11,R12, R19	0	Film Resistor;5%	0603	Yageo	RC0603JR-070RL
1	R5	51k	Film Resistor;1%	0603	Yageo	RC0603FR-0751KL
1	R7	0.007	Film Resistor;1%;1W	2512	CYNTEC	RL3264-6-R007-FN
1	R8	63.4k	Film Resistor;1%	0603	Yageo	RC0603FR-0763K4L
1	R9	12k	Film Resistor;1%	0603	Yageo	RC0603FR-0712KL
1	R13	2.2	Film Resistor;1%	0603	Yageo	RC0603FR-072R2L
1	R14	10	Film Resistor;1%	0805	Yageo	RC0805FR-0710RL
1	R16	1M	Film Resistor;1%	0603	Yageo	RC0603FR-071ML
1	R18	10	Film Resistor;1%	0603	Yageo	RC0603FR-0710RL
2	R10, R17	NS		0603		
1	U1		Synchronous Step- Down Controller	TSSOP20 -EP	MPS	MPQ2908AGF

## TYPICAL PERFORMANCE CHARACTERISTICS

$V_{IN} = 24V$ ,  $V_{OUT} = 5V$ ,  $L = 4.7\mu H$ ,  $T_A = +25^\circ C$ , AAM, unless otherwise noted.

### Efficiency vs. Load Current

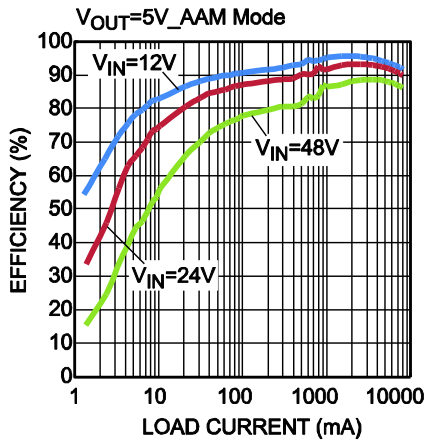

### Efficiency vs. Load Current

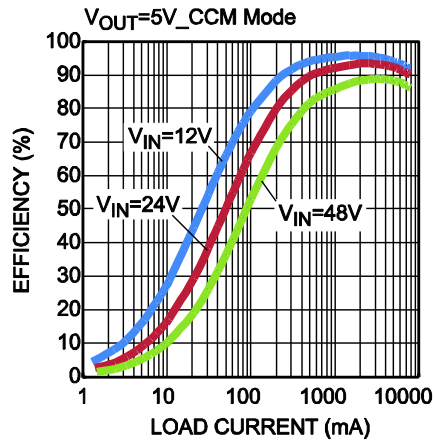

### IC Thermal Rise

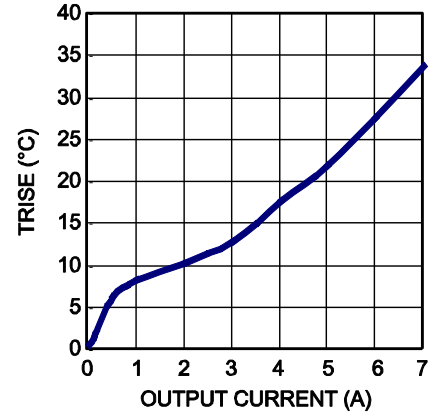

### Load Regulation

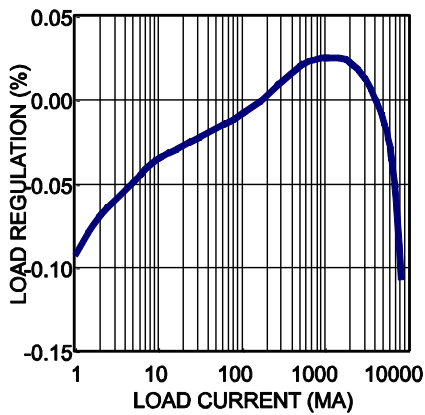

### Line Regulation

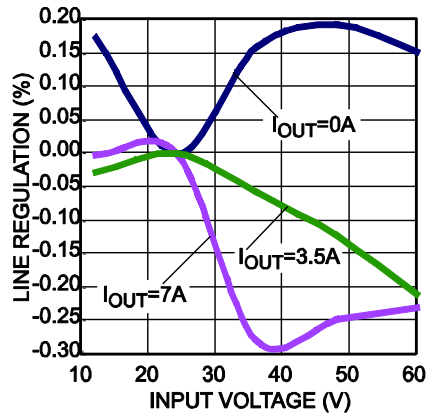

### Positive Spike

$V_{IN}=60V$ ,  $V_{OUT}=5V$ ,  
 $I_{OUT}=7A$ ,  $V_{SW\_MAX}=61.8V$

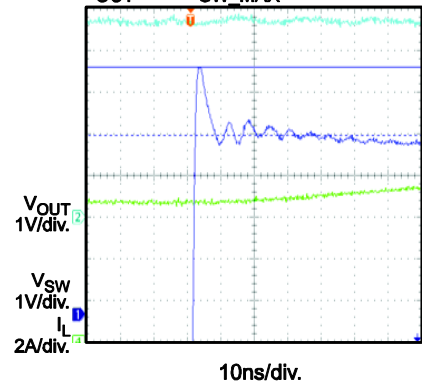

### Negative Kick

$V_{IN}=60V$ ,  $V_{OUT}=5V$ ,  
 $I_{OUT}=7A$ ,  $V_{SW\_MIN}=-4.78V$

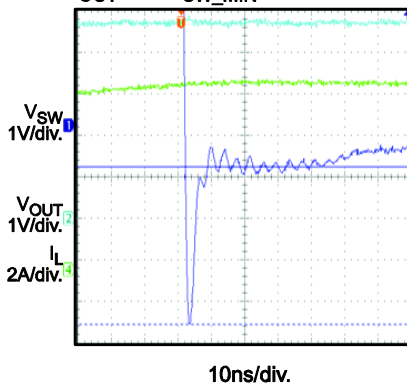

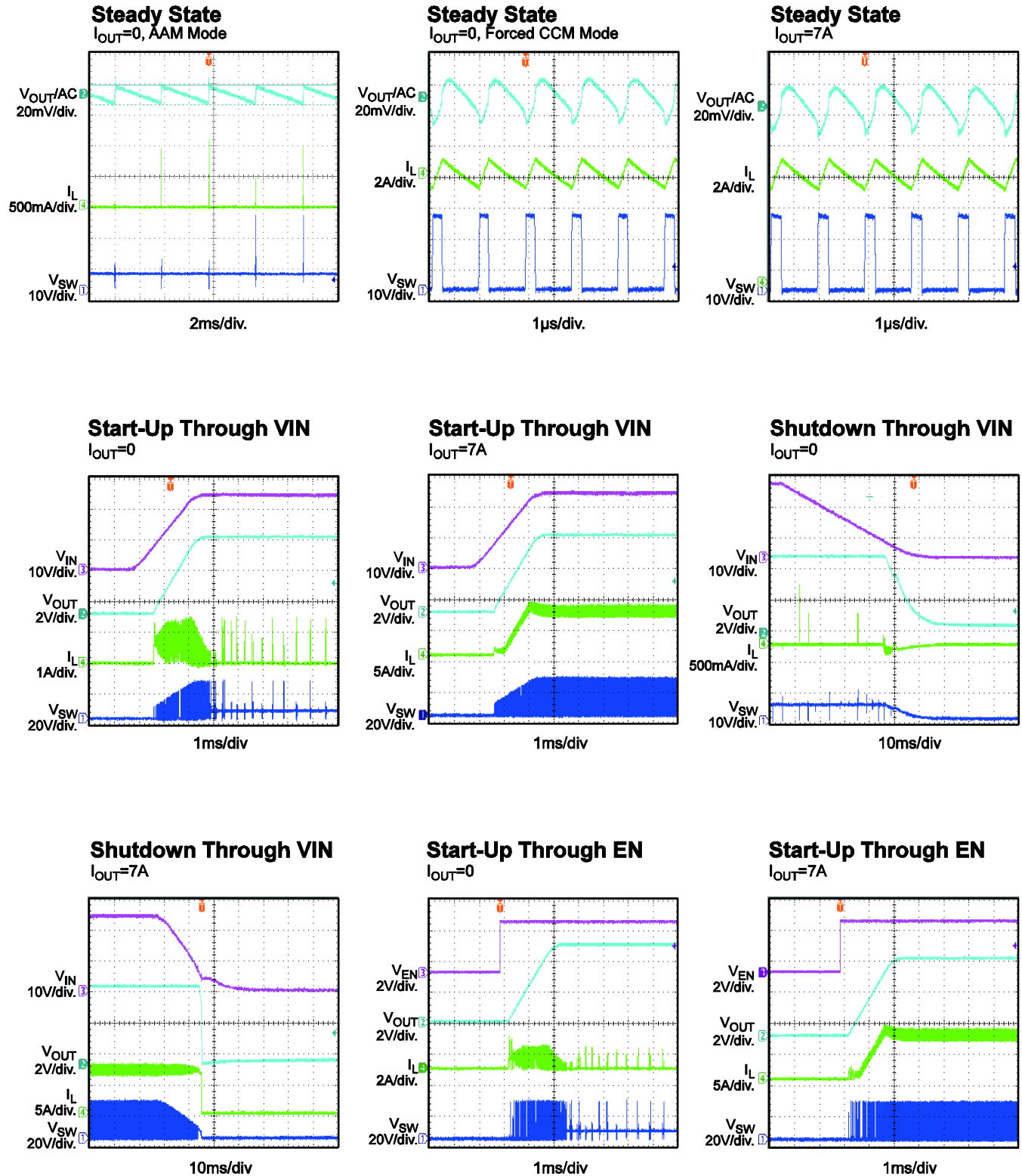
**TYPICAL PERFORMANCE CHARACTERISTICS (continued)**
 $V_{IN} = 24V$ ,  $V_{OUT} = 5V$ ,  $L = 4.7\mu H$ ,  $T_A = +25^\circ C$ , AAM, unless otherwise noted.

**TYPICAL PERFORMANCE CHARACTERISTICS (continued)**
 $V_{IN} = 24V$ ,  $V_{OUT} = 5V$ ,  $L = 4.7\mu H$ ,  $T_A = +25^\circ C$ , AAM, unless otherwise noted.

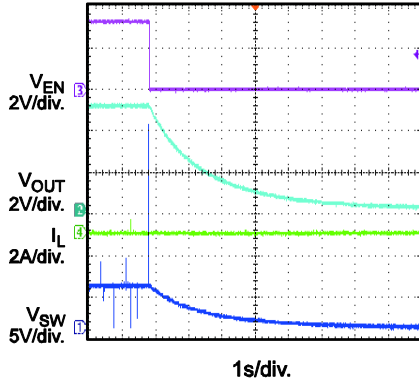
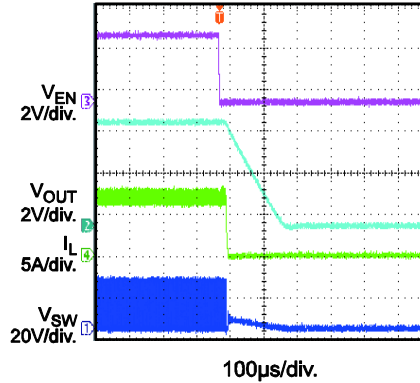
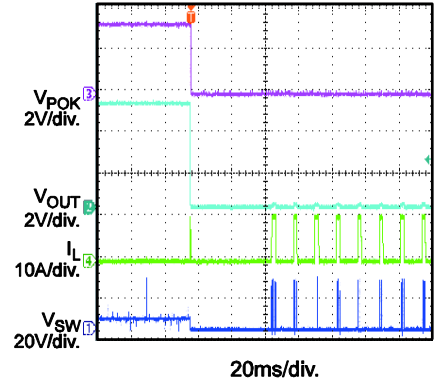
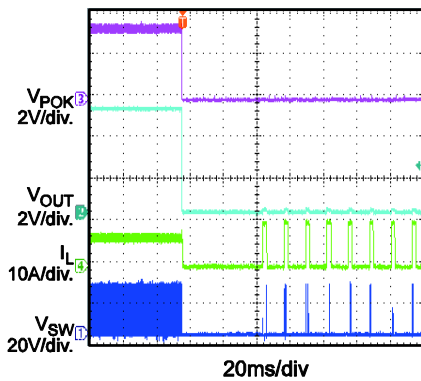
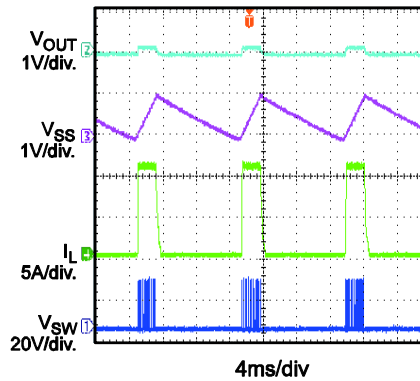
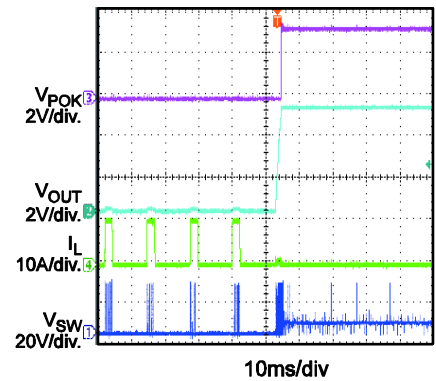
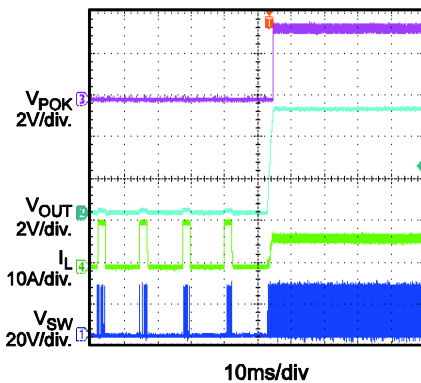
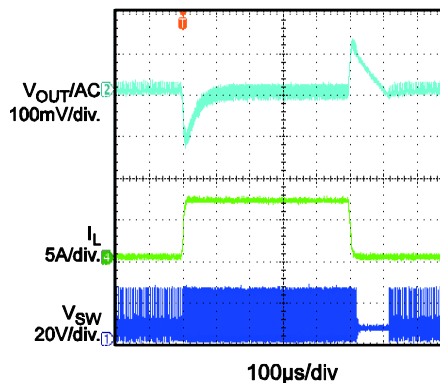
**Shutdown Through EN**  
 $I_{OUT}=0$ 

**Shutdown Through EN**  
 $I_{OUT}=7A$ 

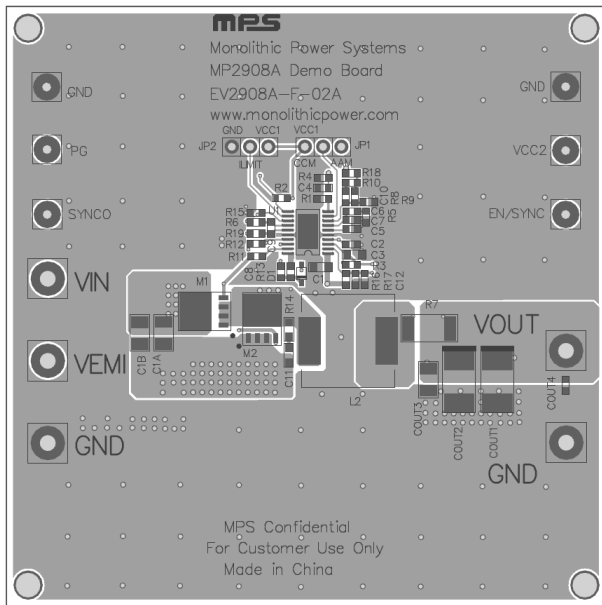
**SCP Entry**  
 $I_{OUT}=0$  to short circuit

**SCP Entry**  
 $I_{OUT}=7A$  to short circuit

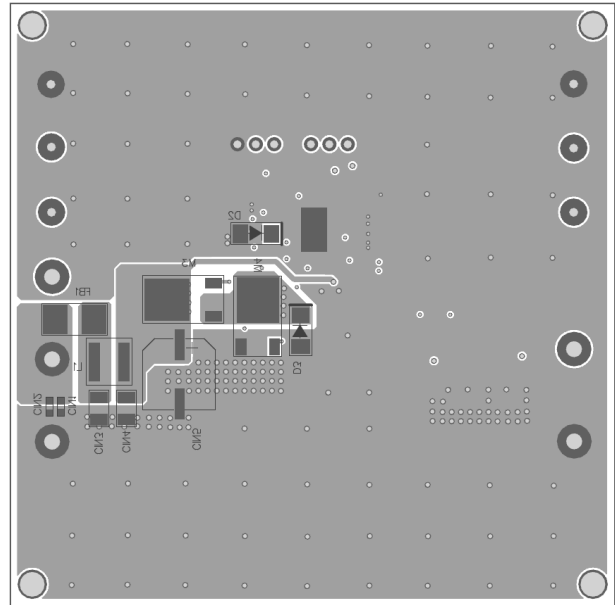
**SCP Steady State**

**SCP Recovery**  
 short circuit to  $I_{OUT}=0$ 

**SCP Recovery**  
 short circuit to  $I_{OUT}=7A$ 

**Load Transient**  
 $I_{OUT}=0.2A \leftrightarrow 7A$ ,  $1.6A/\mu s$ 

## PRINTED CIRCUIT BOARD LAYOUT



**Figure 1—Top Silk & Top Layer**



**Figure 2—Bottom Silk & Bottom Layer**

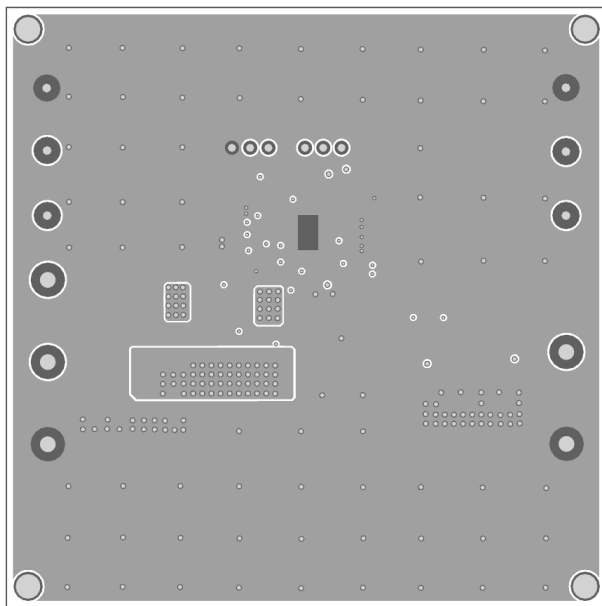

**Figure 3—Inner Layer 1**

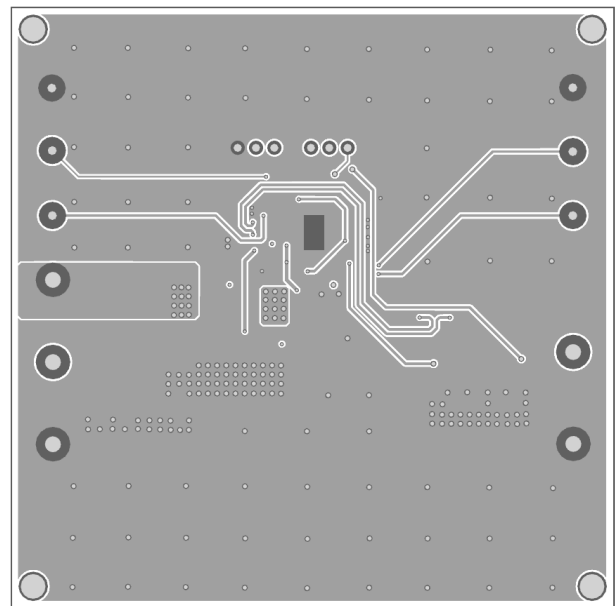

**Figure 4—Inner Layer 2**

## QUICK START GUIDE

1. Connect the positive and negative terminals of the load to the VOUT and GND pins, respectively. Set load current between 0-7A. Be aware that electronic loads represent a negative impedance to the regulator and if set to a too high current will trigger over-current-protection or short-current-protection.
2. Preset the power supply output between 6V and 60V, and then turn off the power supply. If longer cables are used between the source and the EVB (>0.5m total), a damping capacitor should be installed at the input terminals, especially when  $V_{IN} \geq 24V$ .
3. Connect the positive and negative terminals of the power supply output to the VIN and GND pins, respectively.
4. Turn the power supply on. The board will automatically start up. The default  $V_{OUT}$  is 5V.
5. The external resistor divider R8 and R9 are used to set the output voltage.

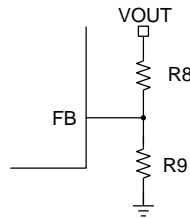

If R8 is known, then R9 can be calculated with below Equation:

$$R_9 = \frac{R_8}{\frac{V_{OUT}}{0.8V} - 1}$$

Below table lists the recommended feedback resistor values for common output voltages.

$V_{OUT}$ (V)	R8 (k $\Omega$ )	R9 (k $\Omega$ )
3.3	37.4 (1%)	12 (1%)
5	63.4 (1%)	12 (1%)
12	169 (1%)	12 (1%)

6. To get better EMI performance, add the EMI components at bottom layer of the board and connect the input power supply between VEMI and GND.
7. To use EN turning on/off MP2908A, remove R16 first. Then give a voltage between EN and GND higher than 1.22V to turn on, lower than 1.09V to turn off. To use the SYNC function, connect an external clock with a range of 100 kHz to 1000 kHz to synchronize the internal clock rising edge to the external clock rising edge.
8. SYNCO can output an out of phase 180°C clock when part works at CCM mode for dual channel co-pack.
9. Note that if part works at high Vin and high Fsw condition, please make sure that Trise of HS MOS no higher than 175°C.

**NOTICE:** The information in this document is subject to change without notice. Please contact MPS for current specifications. Users should warrant and guarantee that third party Intellectual Property rights are not infringed upon when integrating MPS products into any application. MPS will not assume any legal responsibility for any said applications.