

DESCRIPTION

The EV28164-D-00A Evaluation Board is designed to demonstrate the capabilities of MPS' MP28164.

The MP28164 is a highly-efficient, low quiescent current Buck-Boost converter, which operates from input voltage above, below and equal to the output voltage. The device provides power solution for products powered by a one-cell Lithium-Ion or multi-cell alkaline battery applications where the output voltage is within battery voltage range.

The MP28164 operates with input voltage from 1.2V to 5.5V to provide adjustable output voltage (1.5V to 5V), and is available in QFN10-3x3mm package.

ELECTRICAL SPECIFICATION

Parameter	Symbol	Value	Units
Start-Up Voltage	V _{ST}	1.8-5.5	V
Operation Voltage	V _{IN}	1.2 – 5.5	V
Output Voltage	V _{OUT}	3.3	V
Output Current	I _{OUT}	0 – 2 ⁽¹⁾	A

FEATURES

- 1.8V minimum startup input voltage
- 1.2V to 5.5V input work range
- 4A switching current limit
- 2MHz switching frequency
- Selectable PSM / PWM mode.
- Typical 25µA Quiescent current
- High efficiency up to 95%.
- Load disconnect during shutdown
- Internal soft start and compensation
- Power good indicator
- Hiccup mode for SCP
- OTP, OVP
- small QFN-11(2mmx3mm) package

APPLICATIONS

- Battery-powered product
- Portable instruments
- Tablet PC
- Super-cap Charger

All MPS parts are lead-free and adhere to the RoHS directive. For MPS green status, please visit MPS website under Products, Quality Assurance page.

"MPS" and "The Future of Analog IC Technology", are Registered Trademarks of Monolithic Power Systems, Inc.

Note 1): This board can support 2A load if V_{IN}>2.4V, the load capability is lower when V_{IN}<2.4V due to inductor peak current limit.

EV28164-D-00A EVALUATION BOARD



(L × W × H) 5.08cm × 5.08cm × 1.3cm

Board Number	MPS IC Number
EV28164-D-00A	MP28164GD

Efficiency vs. Output Current

V_{OUT}=3.3V, V_{MODE}=Low, L=1µH

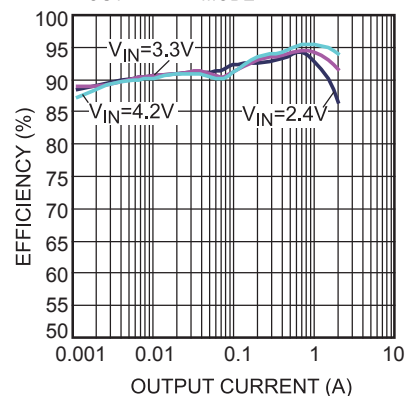

EVALUATION BOARD SCHEMATIC

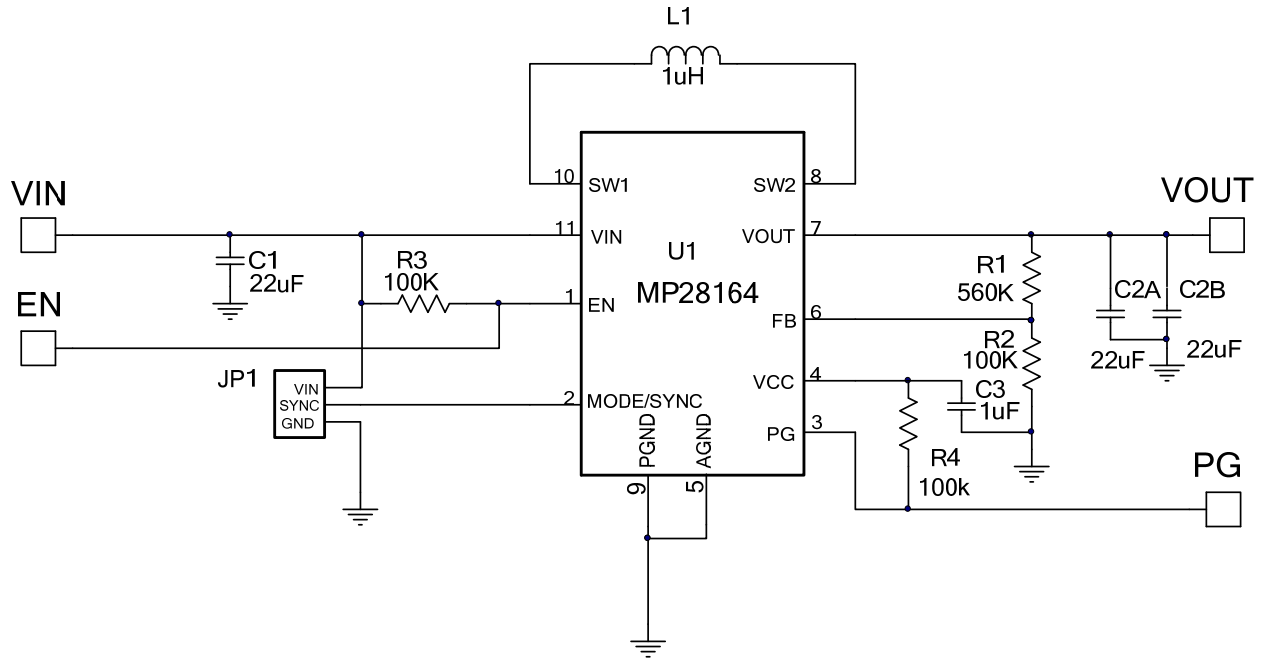

EV28164-D-00A BILL OF MATERIALS

Qty	Ref	Value	Description	Package	Manufacturer	Manufacturer P/N
3	C1, C2A, C2B	22µF	Ceramic Cap,10V,X5R	0805	muRata	GRM21BR61A226KE19L
1	C3	1µF	Ceramic Cap,10V,X7R	0603	muRata	GRM188R71A105KA61D
1	JP1		Header, 3-Pin	DI		
1	L1	1µH	4.6mOhm, 19A inductor	SMD	Würth	744311100
1	R1	560k	Film Res., 1%	0603	Yageo	RC0603FR-07560K
1	R2	100k	Film Res., 1%	0603	Yageo	RC0603FR-07100K
2	R3,R4	100k	Film Res., 5%	0603	Yageo	RC0603JR-07100K
1	U1	MP28164	1.8-5.5V, 2MHz,4A, Buck-Boost Converter	QFN-11 (2mmX3mm)	MPS	MP28164GD

EVB TEST RESULTS

Performance waveforms are tested on the evaluation board.

$V_{IN} = 3.3V$, $V_{OUT} = 3.3V$, $L=1\mu H$, $C_{OUT} = 2x22\mu F$, $T_A = 25^\circ C$, unless otherwise noted.

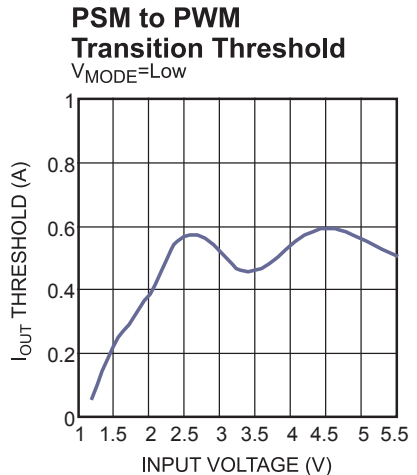
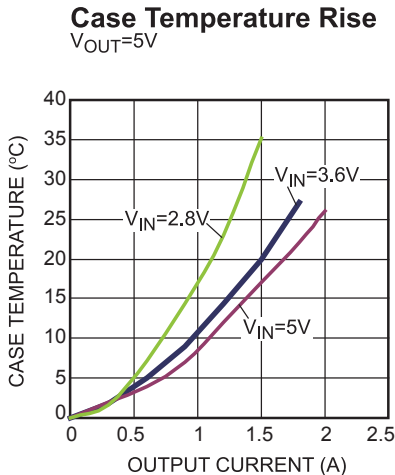
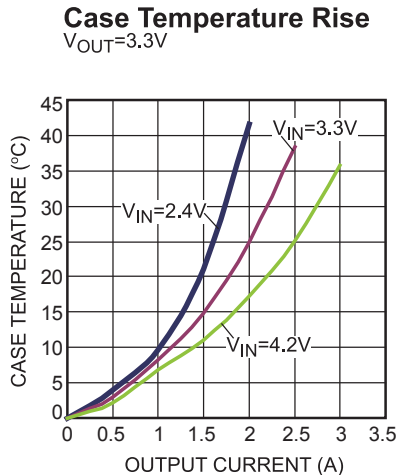
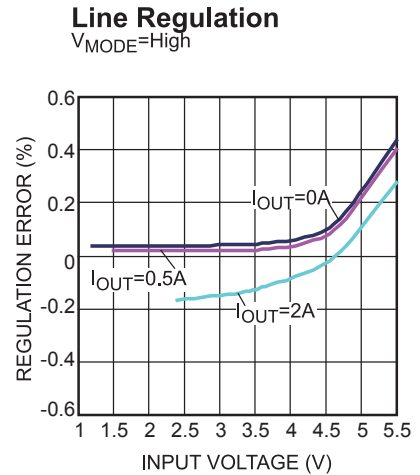
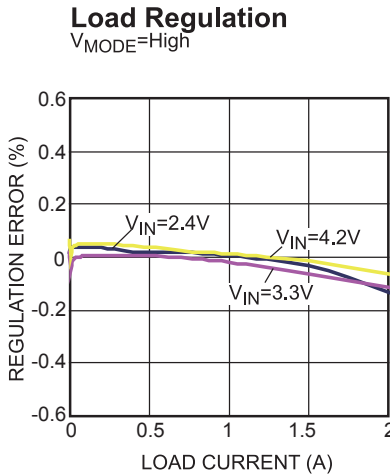
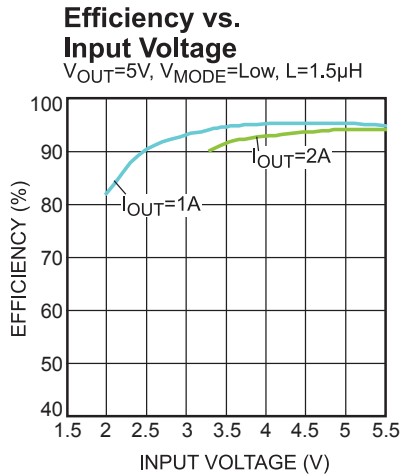
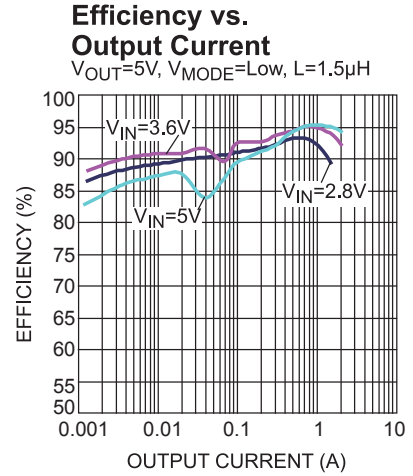
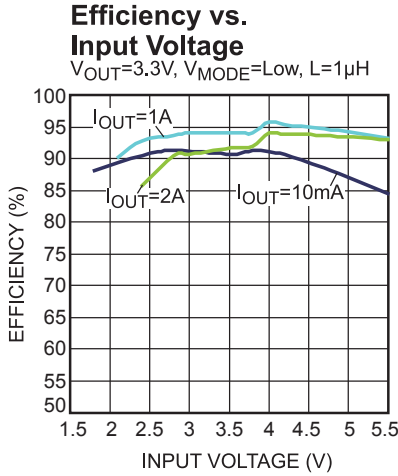
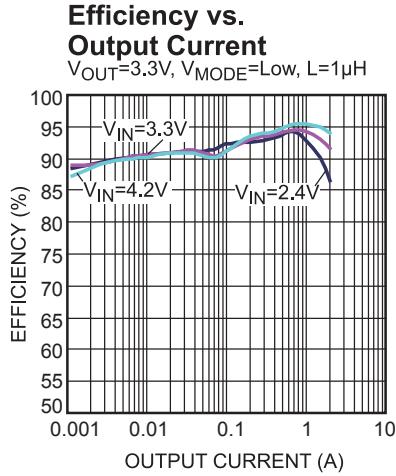

EVB TEST RESULTS (continued)

Performance waveforms are tested on the evaluation board.

$V_{IN} = 3.3V$, $V_{OUT} = 3.3V$, $L=1\mu H$, $C_{OUT} = 2x22\mu F$, $T_A = 25^\circ C$, unless otherwise noted.

Steady State

$V_{IN} = 2.4V$, $I_{OUT} = 2A$,
 $V_{MODE} = High$

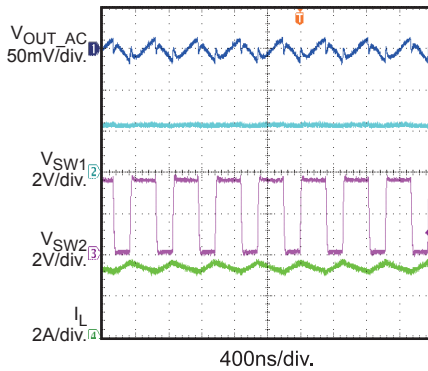

Steady State

$V_{IN} = 3.3V$, $I_{OUT} = 2A$,
 $V_{MODE} = High$

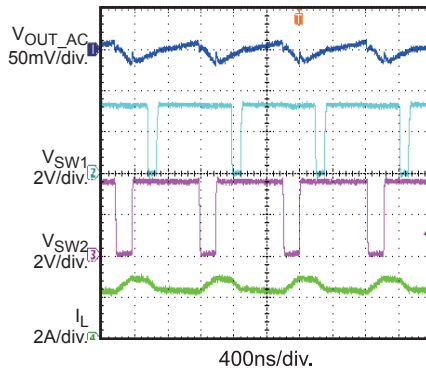

Steady State

$V_{IN} = 4.2V$, $I_{OUT} = 2A$,
 $V_{MODE} = High$

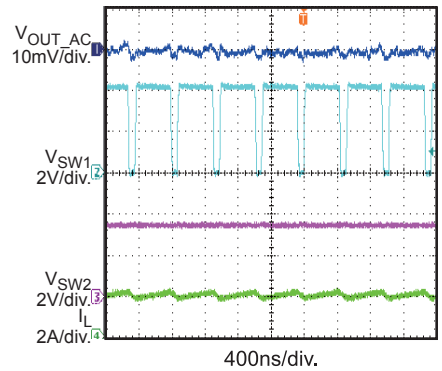

Steady State

$V_{IN} = 2.4V$, $I_{OUT} = 0.2A$,
 $V_{MODE} = High$

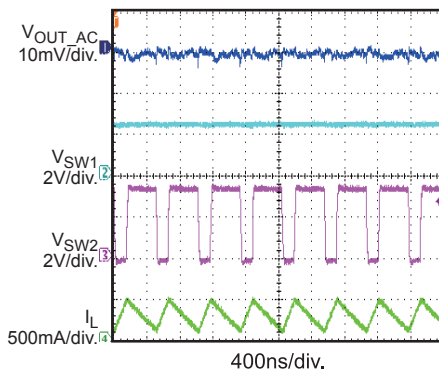

Steady State

$V_{IN} = 3.3V$, $I_{OUT} = 0.2A$,
 $V_{MODE} = High$

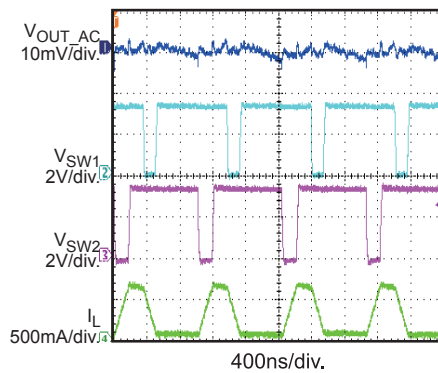

Steady State

$V_{IN} = 4.2V$, $I_{OUT} = 0.2A$,
 $V_{MODE} = High$

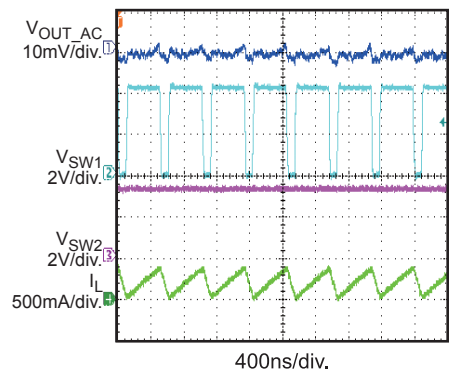

Steady State

$V_{IN} = 2.4V$, $I_{OUT} = 0.2A$,
 $V_{MODE} = Low$

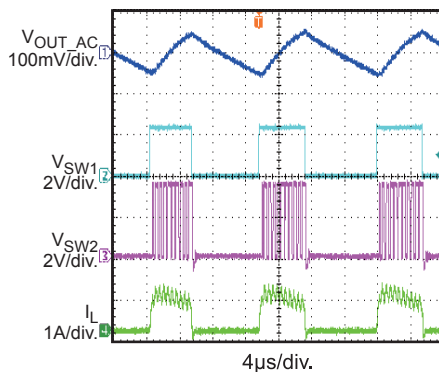

Steady State

$V_{IN} = 3.3V$, $I_{OUT} = 0.2A$,
 $V_{MODE} = Low$

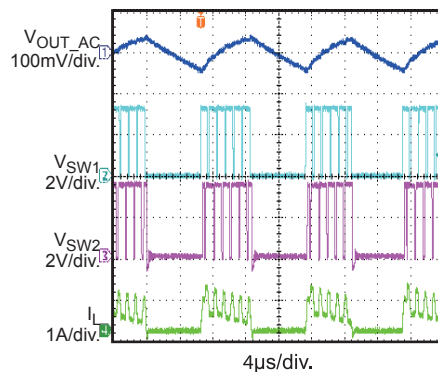

Steady State

$V_{IN} = 4.2V$, $I_{OUT} = 0.2A$,
 $V_{MODE} = Low$

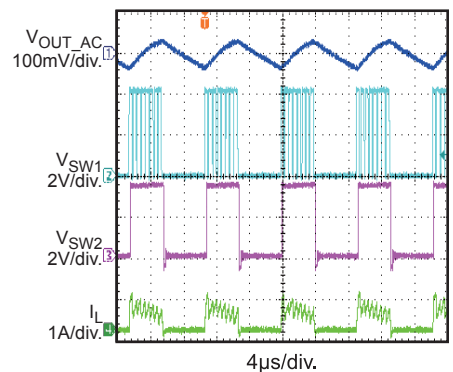

EVB TEST RESULTS (continued)

Performance waveforms are tested on the evaluation board.

$V_{IN} = 3.3V$, $V_{OUT} = 3.3V$, $L=1\mu H$, $C_{OUT} = 2x22\mu F$, $T_A = 25^\circ C$, unless otherwise noted.

Steady State

$V_{IN} = 2.4V$, $I_{OUT} = 2A$,
 $V_{MODE} = Low$

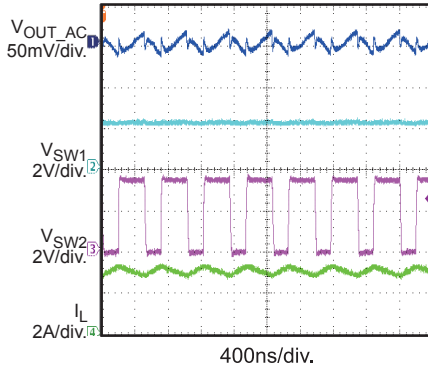

Steady State

$V_{IN} = 3.3V$, $I_{OUT} = 2A$,
 $V_{MODE} = Low$

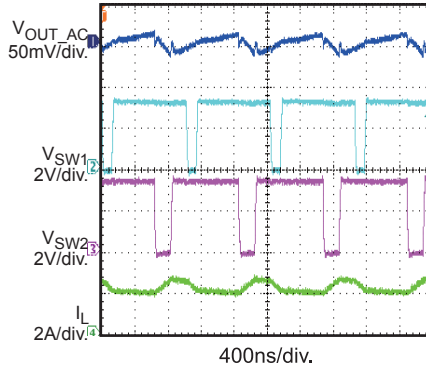

Steady State

$V_{IN} = 4.2V$, $I_{OUT} = 2A$,
 $V_{MODE} = Low$

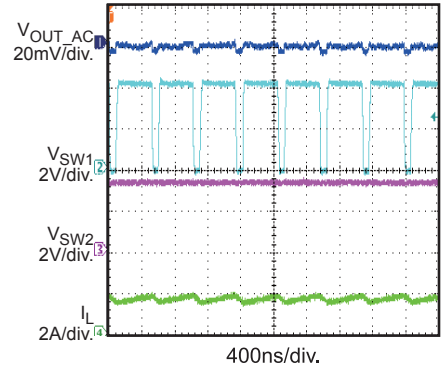

Power On

$I_{OUT} = 0A$, $V_{MODE} = High$

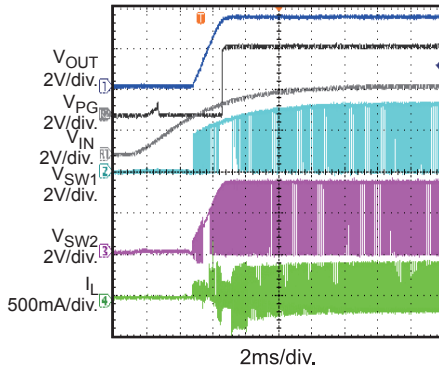

Power On

$I_{OUT} = 0A$, $V_{MODE} = Low$

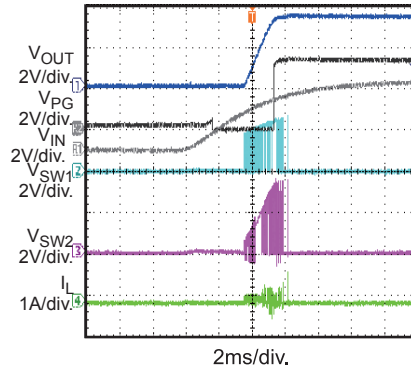

Power On

$I_{OUT} = 1A$, $V_{MODE} = Low$

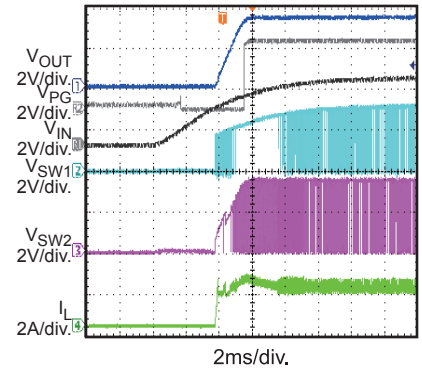

Power Off

$I_{OUT} = 0.01A$, $V_{MODE} = High$

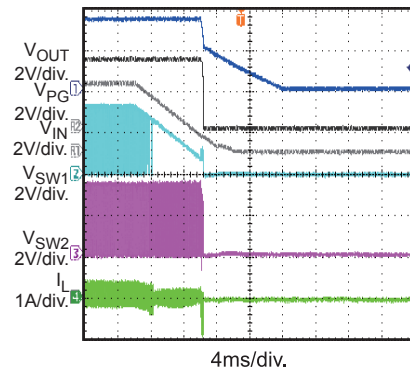

Power Off

$I_{OUT} = 0.01A$, $V_{MODE} = Low$

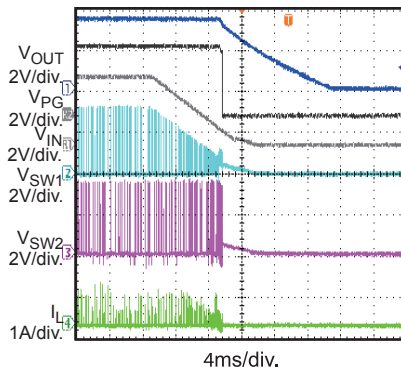

Power Off

$I_{OUT} = 2A$, $V_{MODE} = Low$

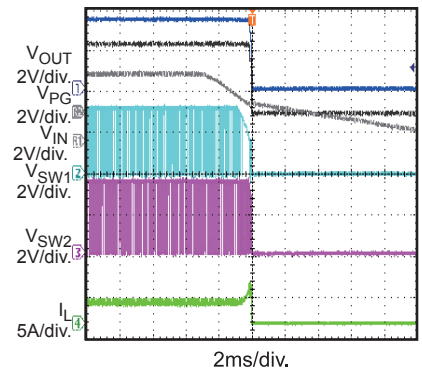

EVB TEST RESULTS (continued)

Performance waveforms are tested on the evaluation board.

$V_{IN} = 3.3V$, $V_{OUT} = 3.3V$, $L=1\mu H$, $C_{OUT} = 2x22\mu F$, $T_A = 25^\circ C$, unless otherwise noted.

EN Start-Up

$I_{OUT} = 0A$, $V_{MODE} = High$

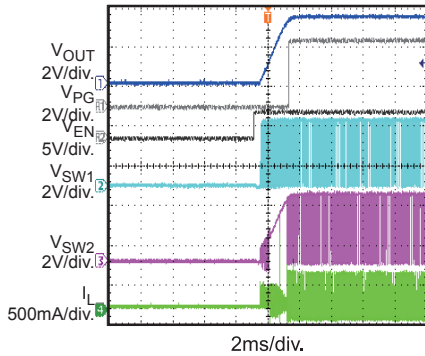

EN Start-Up

$I_{OUT} = 0A$, $V_{MODE} = Low$

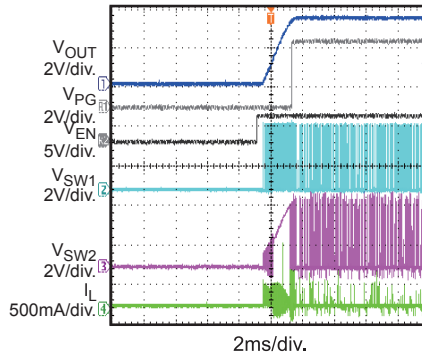

EN Start-Up

$I_{OUT} = 2A$, $V_{MODE} = Low$

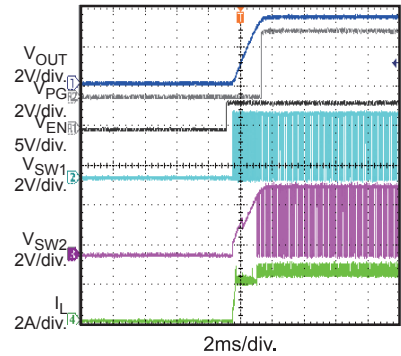

EN Shutdown

$I_{OUT} = 0.01A$, $V_{MODE} = High$

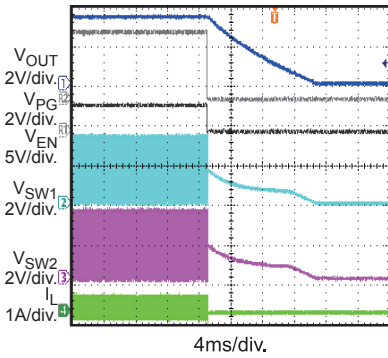

EN Shutdown

$I_{OUT} = 0.01A$, $V_{MODE} = Low$

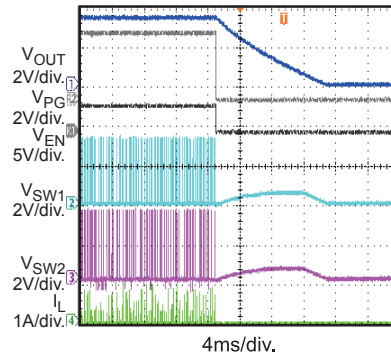

EN Shutdown

$I_{OUT} = 2A$, $V_{MODE} = Low$

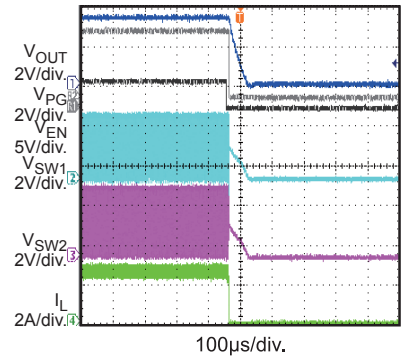

Response to Transient Load

$V_{IN} = 2.4V$, $I_{OUT} = 0.5A$ to $1.5A$,
 $V_{MODE} = High$

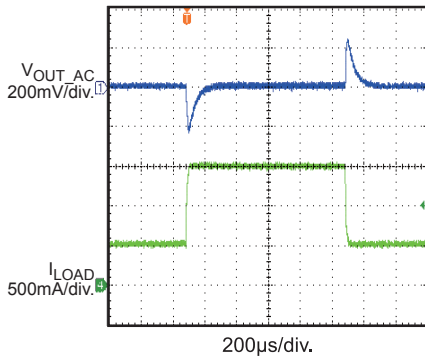

Response to Transient Load

$V_{IN} = 3.3V$, $I_{OUT} = 0.5A$ to $1.5A$,
 $V_{MODE} = High$

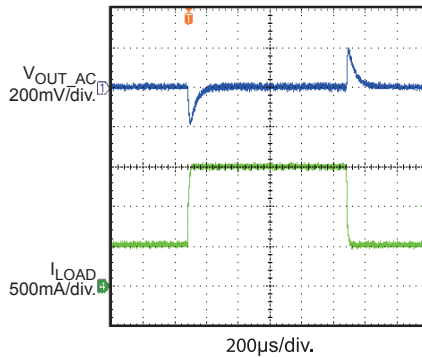

Response to Transient Load

$V_{IN} = 4.2V$, $I_{OUT} = 0.5A$ to $1.5A$,
 $V_{MODE} = High$

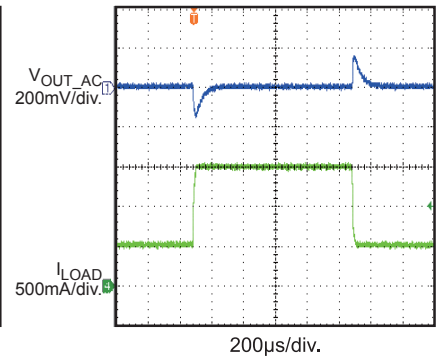

EVB TEST RESULTS *(continued)*

Performance waveforms are tested on the evaluation board.

$V_{IN} = 3.3V$, $V_{OUT} = 3.3V$, $L = 1\mu H$, $C_{OUT} = 2 \times 22\mu F$, $T_A = 25^\circ C$, unless otherwise noted.

Protection for Output Short

$I_{OUT} = 2A$

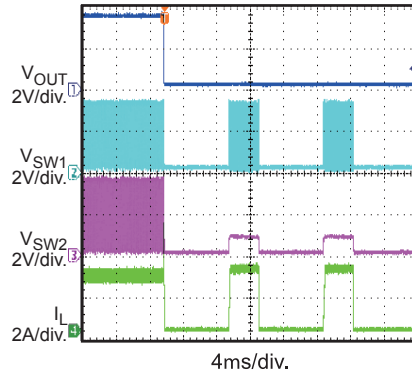

Recovery from Output Short Protection

$I_{OUT} = 2A$

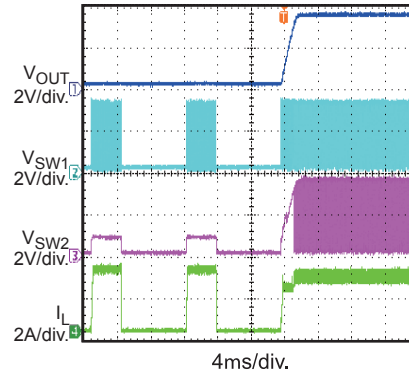

PRINTED CIRCUIT BOARD LAYOUT

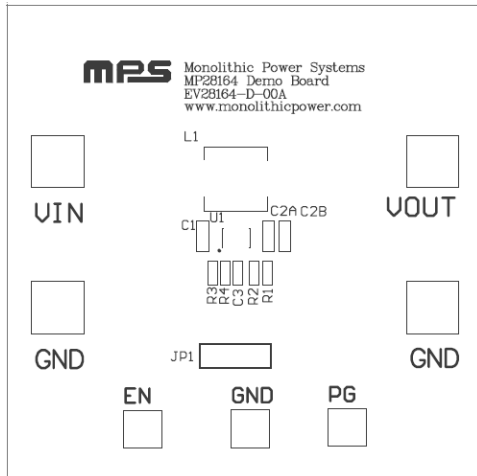

Figure 1: Top Silkscreen Layer

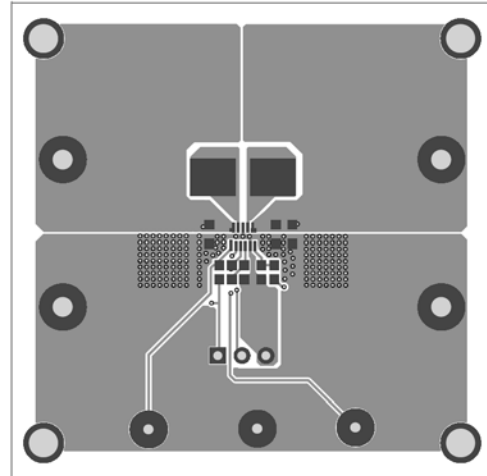

Figure 2: Top Layer

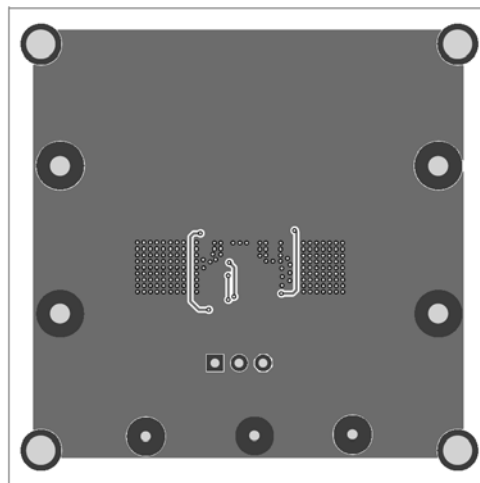

Figure 3: Bottom Layer

QUICK START GUIDE

1. Preset the load to some value, e.g. 0.5A, notice that the MP28164 may enter SCP hiccup if starting up with a heavier load due to the startup current limit which is for inrush protection..
2. Connect the positive and negative terminals of the load to the VOUT and GND pins, respectively.
3. Preset the power supply's output voltage (1.8~5.5V), and then turn off the power supply.
4. Connect the positive and negative terminals of the power supply output to the VIN and GND pins, respectively.
5. Turn on the power supply. The MP28164 demo board will automatically start up.
6. To use the Enable function, apply a digital input to the EN pin. Drive EN higher than 1.2V to turn on the regulator or less than 0.4V to turn it off.
7. To use MODE pin for forced CCM operation, please turn off Vin then connect the jumper JP1 to VIN.
8. If other output voltage is preferred, The output voltage VOUT can be programmed by changing R1 and R2 according to below equation:

$$R2 = R1 \times \frac{V_{FB}}{V_{OUT} - V_{FB}}$$

Where V_{FB} . Is typically 0.5V, and R1, R2's units are in k Ω , V_{OUT} 's unit is in V. The value of R1 is recommended to be from 300 k Ω through 620 k Ω for better efficiency at light load. The recommended output voltage can be from 1.5V through 5V.

NOTICE: The information in this document is subject to change without notice. Please contact MPS for current specifications. Users should warrant and guarantee that third party Intellectual Property rights are not infringed upon when integrating MPS products into any application. MPS will not assume any legal responsibility for any said applications.