

DESCRIPTION

The EV28163-Q-00A Evaluation Board is designed to demonstrate the capabilities of MPS' MP28163.

The MP28163 is a highly efficient, low quiescent current Buck-Boost converter, which operates from input voltage above, below and equal to the output voltage. The device provides power solution for products powered by a one-cell Lithium-Ion or multi-cell alkaline battery applications where the output voltage is within battery voltage rang.

The MP28163 operates with input voltage from 2V to 5.5V to provide adjustable output voltage (1.5V to 5V), and is available in QFN10-3x3mm package.

ELECTRICAL SPECIFICATION

Parameter	Symbol	Value	Units
Supply Voltage	V_{IN}	2 – 5.5	V
Output Voltage	V_{OUT}	3.3	V
Output Current	I_{OUT}	0 – OCP	A

FEATURES

- High efficiency up to 95%.
- Load disconnect during shutdown
- Input voltage range: 2V to 5.5V
- adjustable output voltage from 1.5V to 5V
- 1MHz switching frequency
- Pulse skipping mode at light load
- Typical 80uA quiescent current
- Internal loop compensation for fast response
- Internal soft start
- OTP, hiccup SCP
- Available in small QFN10-3x3 package

APPLICATIONS

- Battery-powered products
- Portable instruments
- Tablet PCs
- POS systems

All MPS parts are lead-free and adhere to the RoHS directive. For MPS green status, please visit MPS website under Products, Quality Assurance page.

"MPS" and "The Future of Analog IC Technology", are Registered Trademarks of Monolithic Power Systems, Inc.

EV28163-Q-00A EVALUATION BOARD



(L × W × H) 5.08cm × 5.08cm × 1.3cm

Board Number	MPS IC Number
EV28163-Q-00A	MP28163GQ

Efficiency vs. Output Current
MODE=LOW

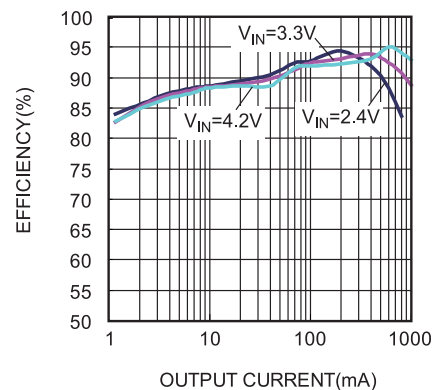

EVALUATION BOARD SCHEMATIC

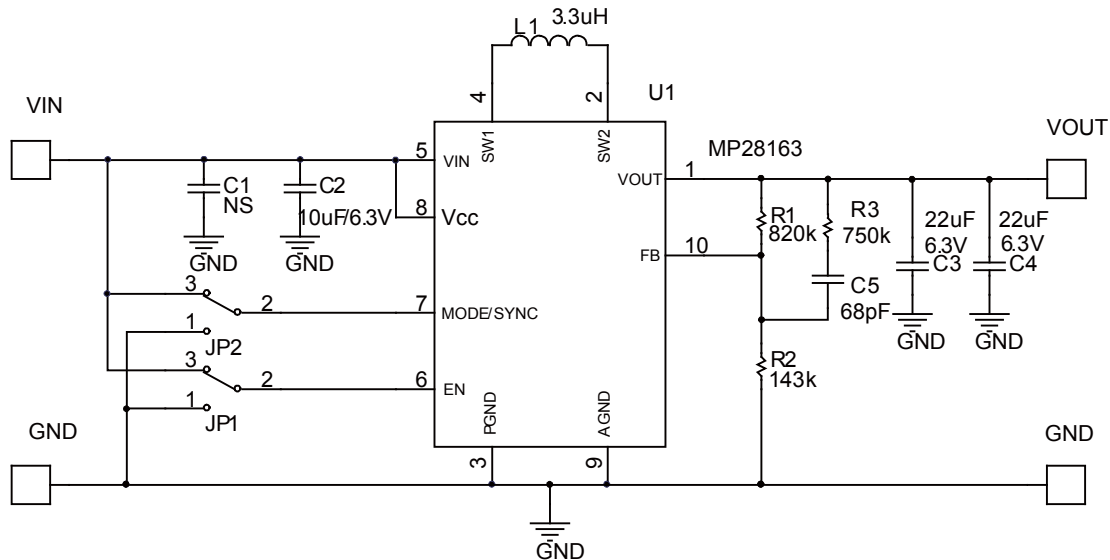

EV28163-Q-00A BILL OF MATERIALS

Qty	RefDes	Value	Description	Manufacturer	Manufacturer P/N	Package
1	C1	NS				0805
1	C2	10uF	6.3V X7R ceramic capacitor	muRata	GRM21BR60J106KE19D	0805
2	C3, C4	22uF	6.3V X5R ceramic capacitor	muRata	GRM21BR60J226ME39L	0805
1	C5	68pF	50V, X7R ceramic Capacitor	muRata	GRM188R71H680KL	0603
2	JP1, JP2		3 pins header			DI
1	L1	3.3uH	9mOhm, 8A inductor	Würth	744314330	SMD
1	R1	820k	Film resistor, 1%	YAGEO	RC0603FR-07820KL	0603
1	R2	143k	Film resistor, 1%	YAGEO	RC0603FR-07143KL	0603
1	R3	750k	Film resistor, 5%	YAGEO	RC0603JR-07750KL	0603
1	U1	MP28163	2~5.5V, 2.6A buck-boost converter	MPS	MP28163GQ	QFN10-3*3

EVB TEST RESULTS

Performance waveforms are tested on the evaluation board.

$V_{IN} = 3.3V$, $V_{OUT} = 3.3V$, $L = 3.3\mu H$, $C_{OUT}=2x22\mu F$, $T_A = 25^\circ C$, unless otherwise noted.

Efficiency vs. Output Current
MODE=LOW

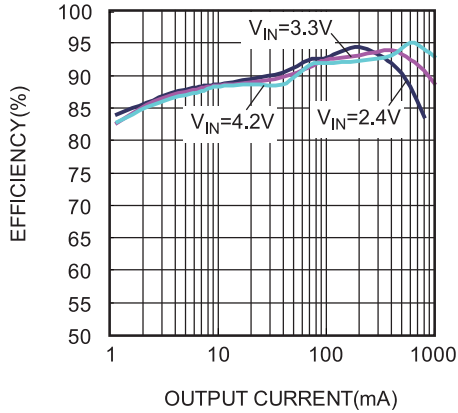

Efficiency vs. Input Voltage
MODE=LOW

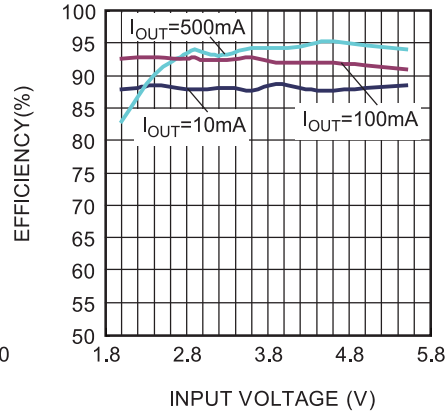

Load Regulation
MODE=HIGH

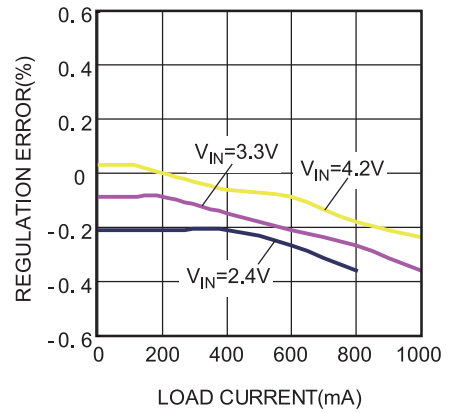

Line Regulation
MODE=HIGH

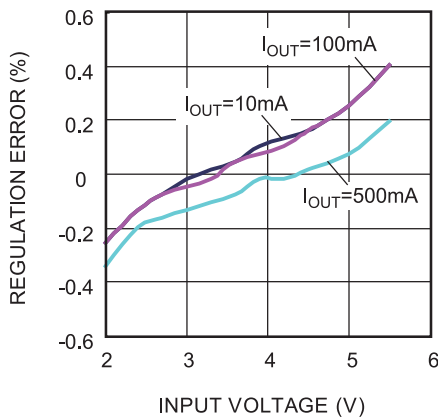

EVB TEST RESULTS (continued)

Performance waveforms are tested on the evaluation board.

$V_{IN} = 3.3V$, $V_{OUT} = 3.3V$, $L = 3.3\mu H$, $C_{OUT} = 2 \times 22\mu F$, $T_A = 25^\circ C$, unless otherwise noted.

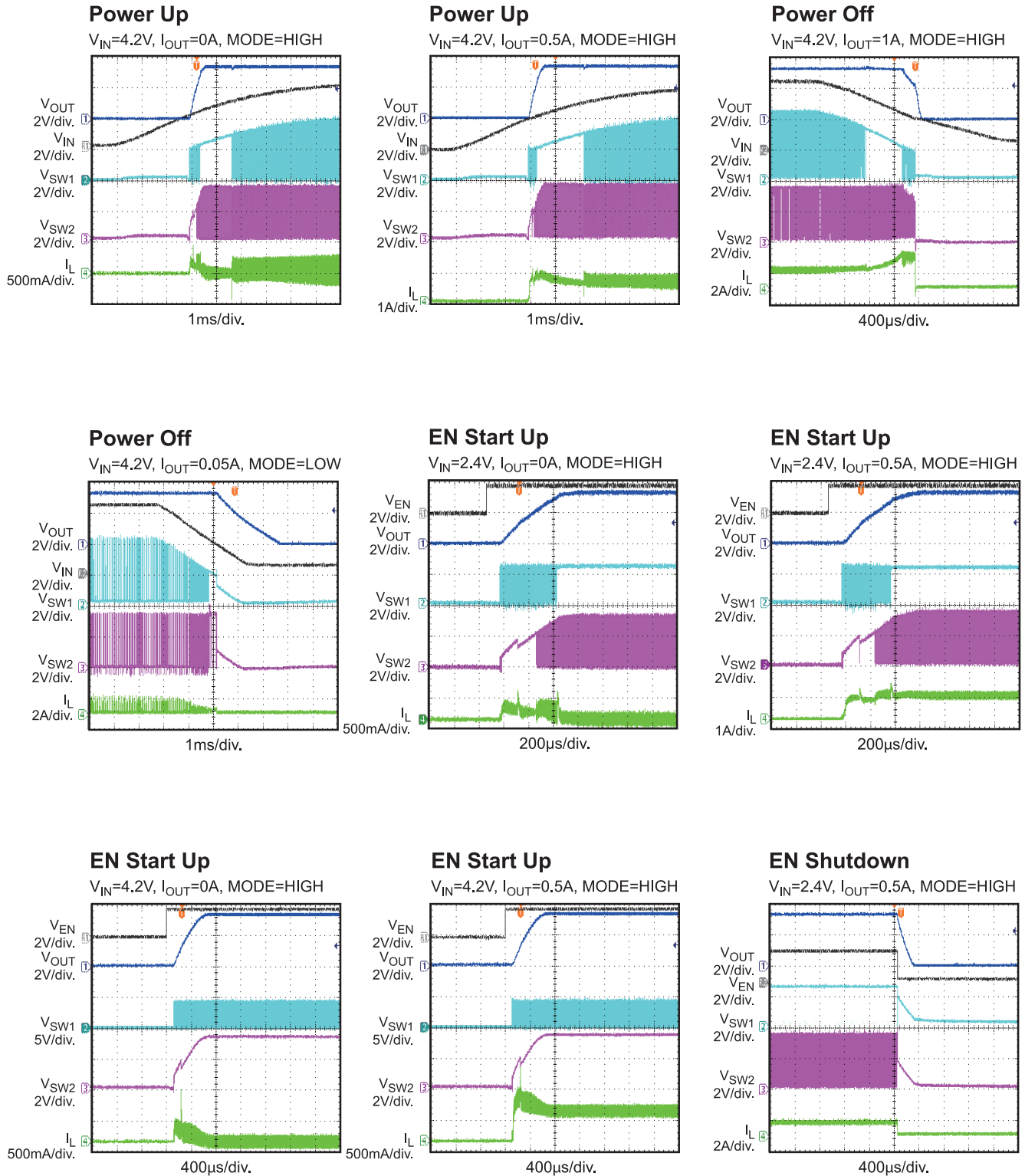

EVB TEST RESULTS (continued)

Performance waveforms are tested on the evaluation board.

$V_{IN} = 3.3V$, $V_{OUT} = 3.3V$, $L = 3.3\mu H$, $C_{OUT} = 2 \times 22\mu F$, $T_A = 25^\circ C$, unless otherwise noted.

EN Shutdown

$V_{IN} = 2.4V$, $I_{OUT} = 0.05A$, MODE=LOW

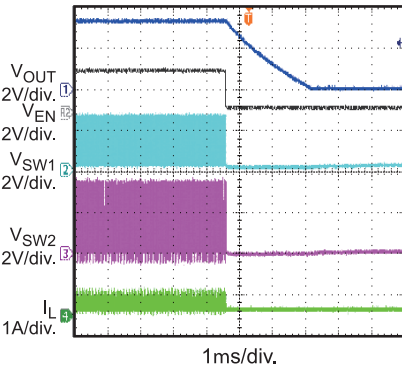

EN Shutdown

$V_{IN} = 4.2V$, $I_{OUT} = 1A$, MODE=HIGH

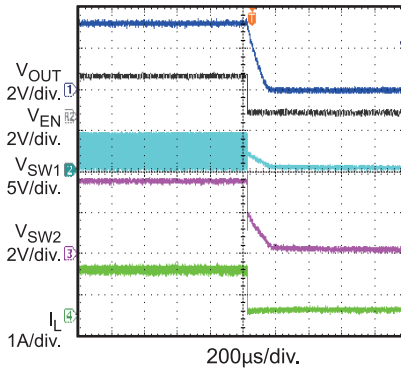

EN Shutdown

$V_{IN} = 4.2V$, $I_{OUT} = 0.05A$, MODE=LOW

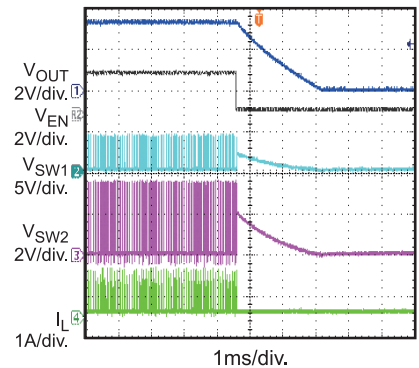

Steady State

$V_{IN} = 2.4V$, $I_{OUT} = 0.8A$, MODE=HIGH

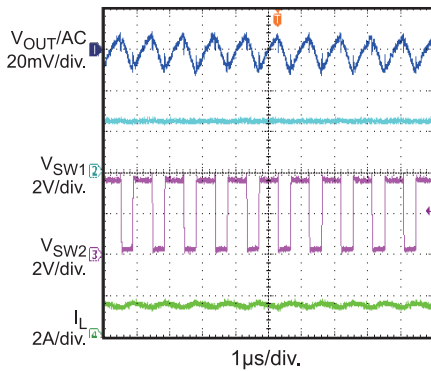

Steady State

$V_{IN} = 3.3V$, $I_{OUT} = 1A$, MODE=HIGH

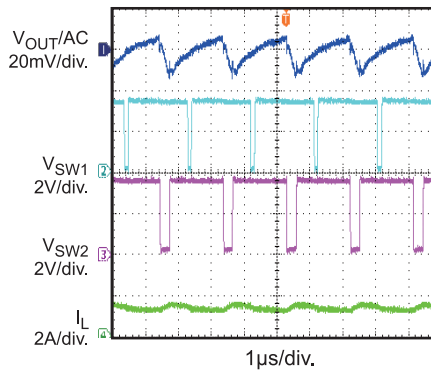

Steady State

$V_{IN} = 4.2V$, $I_{OUT} = 1.5A$, MODE=HIGH

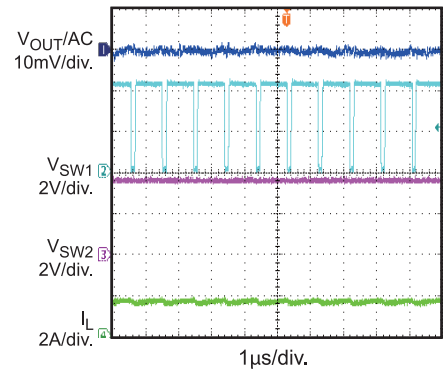

Steady State

$V_{IN} = 2.4V$, $I_{OUT} = 0.05A$, MODE=LOW

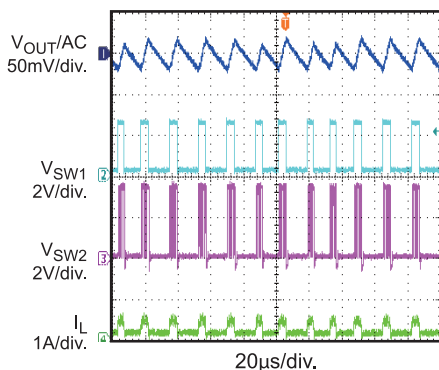

Steady State

$V_{IN} = 3.3V$, $I_{OUT} = 0.05A$, MODE=LOW

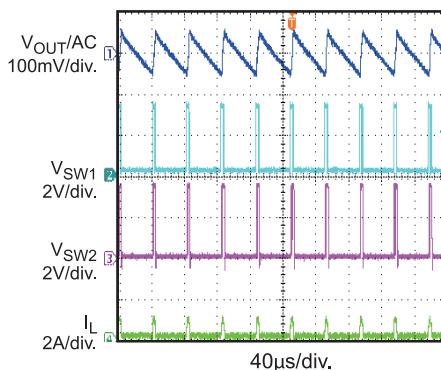

Steady State

$V_{IN} = 4.2V$, $I_{OUT} = 0.05A$, MODE=LOW

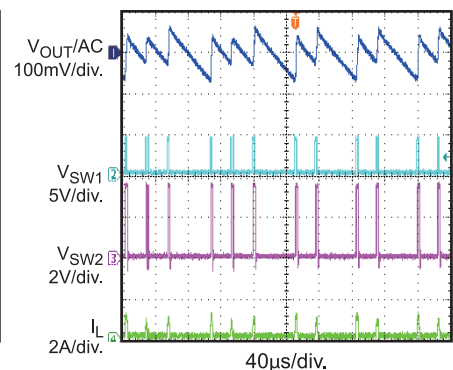

EVB TEST RESULTS (continued)

Performance waveforms are tested on the evaluation board.

$V_{IN} = 3.3V$, $V_{OUT} = 3.3V$, $L = 3.3\mu H$, $C_{OUT} = 2 \times 22\mu F$, $T_A = 25^\circ C$, unless otherwise noted.

Load Transient Response

$V_{IN} = 2.4V$, $I_{OUT} = 0.2 \rightarrow 0.6A @ 250mA/\mu s$,
MODE=HIGH

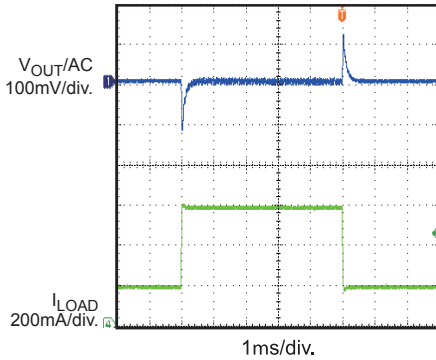

Load Transient Response

$V_{IN} = 3.3V$, $I_{OUT} = 0.2 \rightarrow 0.8A @ 250mA/\mu s$,
MODE=HIGH

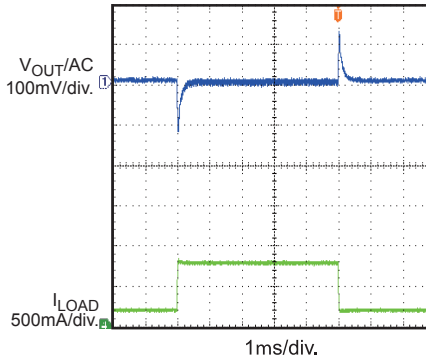

Load Transient Response

$V_{IN} = 4.2V$, $I_{OUT} = 0.3 \rightarrow 1A @ 250mA/\mu s$,
MODE=HIGH

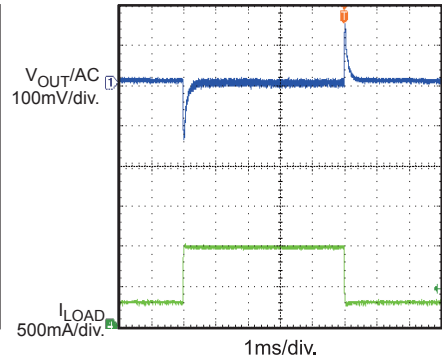

SCP Entry

$V_{IN} = 2.4V$, $I_{OUT} = 0.5A$, MODE=HIGH

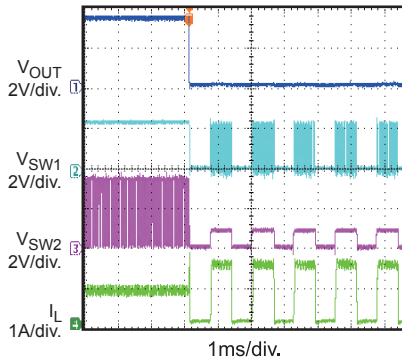

SCP Recovery

$V_{IN} = 2.4V$, $I_{OUT} = 0.5A$, MODE=HIGH

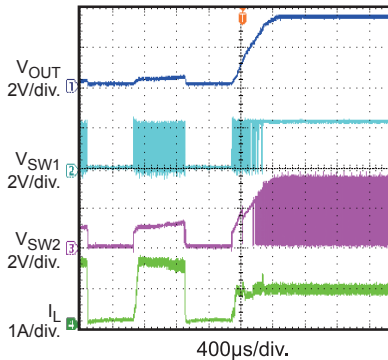

SCP Entry

$V_{IN} = 4.2V$, $I_{OUT} = 0.5A$, MODE=HIGH

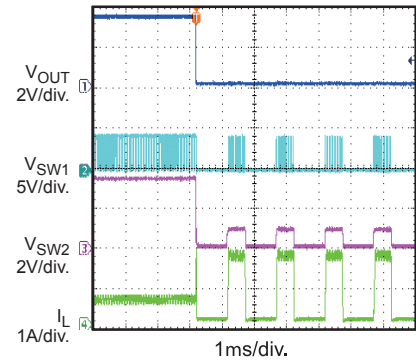

SCP Recovery

$V_{IN} = 4.2V$, $I_{OUT} = 0.5A$, MODE=HIGH

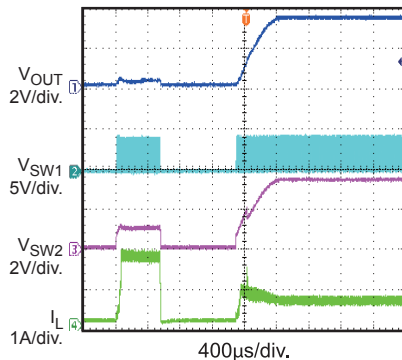

PRINTED CIRCUIT BOARD LAYOUT

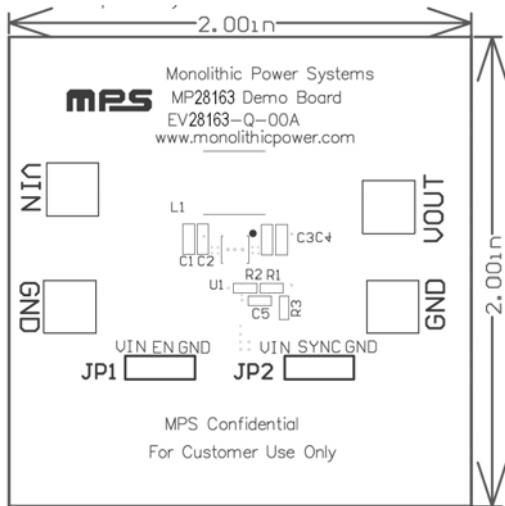

Figure 1: Top Silkscreen Layer

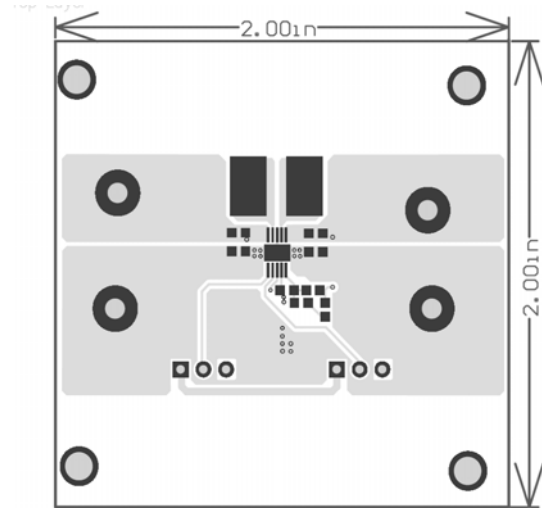

Figure 2: Top Layer

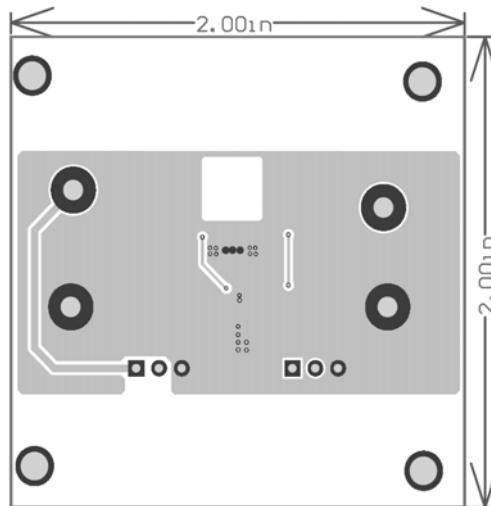

Figure 3: Bottom Silkscreen Layer

QUICK START GUIDE

1. Preset the load to some value, e.g. 0.5A, notice that the MP28163 may enter SCP hiccup if starting up with a heavier load due to the secondary current limit which is for inrush protection..
2. Connect the positive and negative terminals of the load to the VOUT and GND pins, respectively.
3. Preset the power supply output voltage (2~5.5V), and then turn off the power supply.
4. Connect the positive and negative terminals of the power supply output to the VIN and GND pins, respectively.
5. Turn on the power supply. The MP28163 demo board will automatically start up.
6. To use the Enable function, remove the jumper JP1, apply a digital input to the EN pin. Drive EN higher than 1.2V to turn on the regulator or less than 0.4V to turn it off.
7. To use MODE pin for PSM operation, please turn off Vin then connect the jumper JP2 to GND.
8. If other output voltage is preferred, The output voltage VOUT can be programmed by changing R1 and R2 according to below equation:

$$R2 = R1 \times \frac{V_{FB}}{V_{OUT} - V_{FB}}$$

- , where V_{FB} . Is typically 0.496V, and R1, R2's units are in $k\Omega$, V_{OUT} 's unit is in V. The value of R2 is recommended to be from 100 $k\Omega$ through 180 $k\Omega$. The recommended output voltage can be from 1.5V through 5V.

NOTICE: The information in this document is subject to change without notice. Please contact MPS for current specifications. Users should warrant and guarantee that third party Intellectual Property rights are not infringed upon when integrating MPS products into any application. MPS will not assume any legal responsibility for any said applications.