



### DESCRIPTION

The EV2672A-D-00B evaluation board is designed to demonstrate the capabilities of the MP2672A. The MP2672A is a highly integrated, flexible, switch-mode battery charging management device for 2-cell series Li-ion and Li-polymer battery packs. The MP2672A can be used in a wide range of portable applications.

When a 5V adapter or USB input is present, the MP2672A charges the 2-cell battery in step-up mode.

To effectively charge each application, the MP2672A automatically detects the battery voltage, and charges the battery in three phases: pre-charge, constant current (CC) charge, and constant voltage (CV) charge. Other charging features include charge termination and auto-recharge.

To guarantee safe operation, the MP2672A limits the die temperature to a preset value (about 120°C). Other safety features include input over-voltage protection (OVP), battery OVP, thermal shutdown, battery temperature monitoring, and a configurable timer to prevent prolonged charging of a dead battery.

The MP2672A is available in a QFN-18 (2mmx3mm) package.

### ELECTRICAL SPECIFICATIONS

Parameter	Symbol	Value	Units
Input voltage	V <sub>IN</sub>	4.5 to 6.0	V
Pre-charge threshold	V <sub>BATT_PRE</sub>	6.4, I <sup>2</sup> C-configurable	V
Battery charge voltage regulation	V <sub>BATT_REG</sub>	8.4, I <sup>2</sup> C-configurable	V
Fast charge current	I <sub>CC</sub>	2, I <sup>2</sup> C-configurable	A

### FEATURES

- 4.0V to 5.75V Input Voltage Range
- Compatible with Host-Control and Standalone Mode
- Configurable Input Voltage Limit
- Up to 2A Configurable Charge Current for 2-Cell Battery
- Configurable Charge Voltage with 0.5% Accuracy
- No External Sense Resistor Required
- Integrated Cell-Balancing Circuit and Preconditioning for Fully Depleted Battery
- Flexible New Charging Cycle Initiation
- Charging Operation Indicator
- I<sup>2</sup>C Port for Flexible System Parameter Setting and Status Reporting
- Negative Temperature Coefficient (NTC) Pin for Temperature Monitoring
- Built-In Charging Protection and Configurable Safety Timer
- Thermal Regulation and Thermal Shutdown

### APPLICATIONS

- Portable Handheld Solutions
- Point-of-Sale (POS) Machines
- Bluetooth Speakers
- E-Cigarettes
- General 2-Cell Applications

All MPS parts are lead-free, halogen-free, and adhere to the RoHS directive. For MPS green status, please visit the MPS website under Quality Assurance. "MPS", the MPS logo, and "Simple, Easy Solutions" are trademarks of Monolithic Power Systems, Inc. or its subsidiaries.

### EV2672A-D-00B EVALUATION BOARD



Top Layer

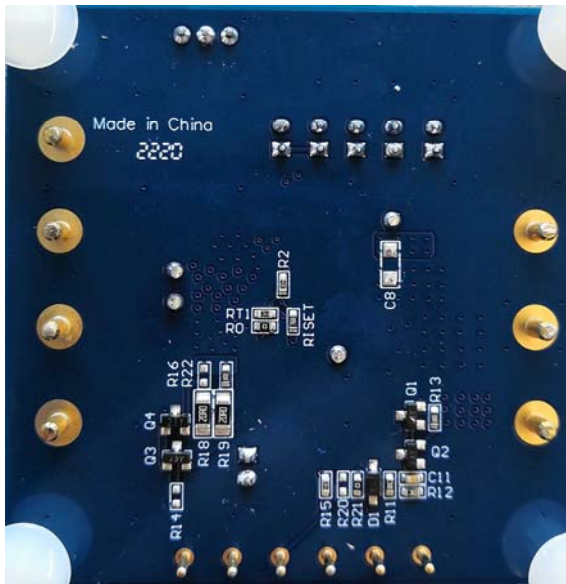

Bottom Layer

(LxWxH) 6.35cmx6.35cmx0.16 cm

Board Number	MPS IC Number
EV2672A-D-00B	MP2672AGD

#### Charge Efficiency Tests On the EVB Constant Current Charge Efficiency

$V_{IN} = 5V (5A)$ ,  $V_{BATT}$  ramping from 6.4V to 8.4V in a constant current loop

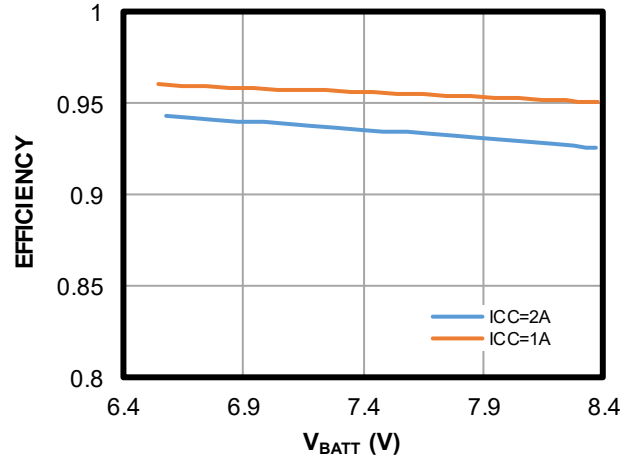

#### Constant Voltage Charge Efficiency

$V_{IN} = 5V (5A)$ ,  $V_{BATT} = 8.4V$ , charge current decreases until charging is done in a constant voltage loop

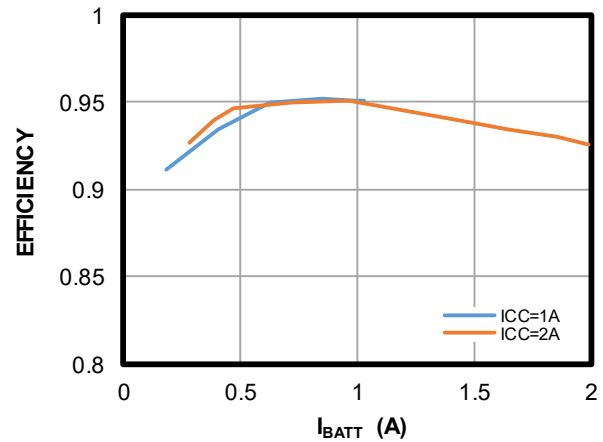

## QUICK START GUIDE

**Table 1: Jumper Connections**

Jumper	Description	Factory Setting
JP1	Standalone mode, BATT_REG = 8.4V	Floating
JP2	Standalone mode, BATT_REG = 8.6V	Floating
JP3	Standalone mode, BATT_REG = 8.7V	Floating
JP4	Standalone mode, BATT_REG = 8.8V	Floating
JP5	Host-control mode, BATT_REG = 8.4V (default)	Connected

**Table 2: Enabling the Cell Balance Function**

Jumper	Floating	Connected	Factory Setting
JP6	Enable the cell balance function	Disable the cell balance function	Connected

This evaluation board is designed for the MP2672A, which can be used as a standalone switching charger with integrated MOSFETs. Its layout accommodates most commonly used components. The default function of this board is preset for host-control mode, and the battery regulation voltage is 8.4V (default) for 2-cell lithium-ion batteries.

The evaluation board can work in two control modes: standalone mode or host-control mode.

### 1. Standalone Mode

Figure 1 shows the test set-up for standalone mode. To operate in standalone mode, connect the CV pin to AGND via a resistor, then set the battery-full voltage.

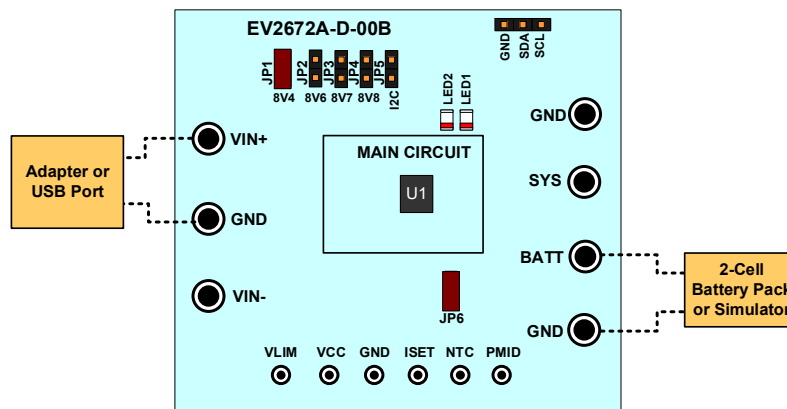
**Figure 1: Test Set-Up for the MP2672A in Standalone Mode**

In standalone mode, the charge current ( $I_{CC}$ ) is configured by the resistor ( $R_{ISET}$ ) connected between the ISET pin and GND.  $R_{ISET}$  should be below 24k $\Omega$ .  $I_{CC}$  can be calculated with Equation (1):

$$I_{CC} (A) = 1(A) \times \frac{12(k\Omega)}{R_{ISET} (k\Omega)} \quad (1)$$

### 2. Host-Control Mode

Figure 2 shows the set-up for host-control mode. For this mode, connect the CV pin to the VCC pin. The battery-full voltage and charge current are set by the I<sup>2</sup>C register.

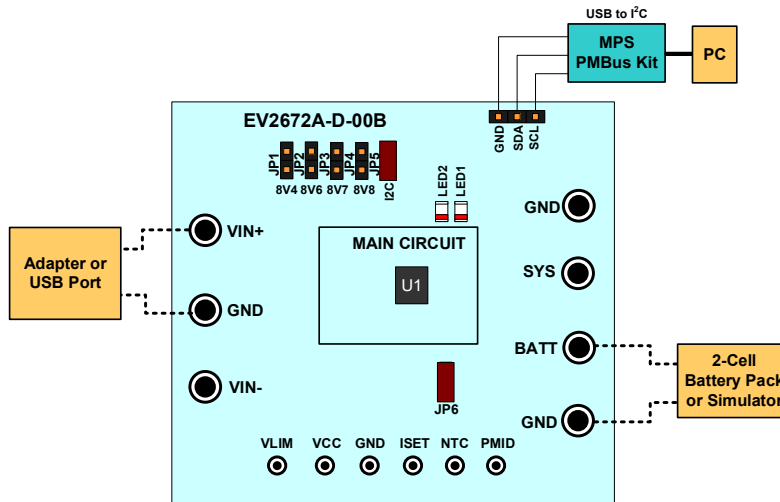

Figure 2: Test Set-Up for the MP2672A in Host-Control Mode

**Evaluation Platform Preparation**

1. Ensure a computer is available with at least one USB port and a USB cable. The MP2672A evaluation software must be properly installed.
2. Ensure that the USB to I<sup>2</sup>C communication kit (EVKT-USBI2C-02) is present (see Figure 3).

**Figure 3: USB to I<sup>2</sup>C Communication Kit**

3. To use the software, double-click on the “MP2672A Evaluation Kit” .exe file to run the MP2672A evaluation software. The software supports the Windows XP, Windows 7, and later operating systems.

The MP2672A evaluation kit.exe file can be downloaded from MPS website.

4. Configure the test set-up for the MP2672A (see Figure 2).
5. Attach the input voltage ( $V_{IN} = 5V$ ) to the VIN pin, and attach the input ground to the GND pin.
6. Connect the battery terminals ( $V_{BATT} = 6.4V$  to  $8.4V$ ) to:
  - a. Positive (+): BATT
  - b. Negative (-): GND

If using a battery simulator, set the voltage to 7.4V with a 5A sink current limit.

7. Turn the computer on, then launch the MP2672A evaluation software. Figure 4 shows the main software window of the GUI software.

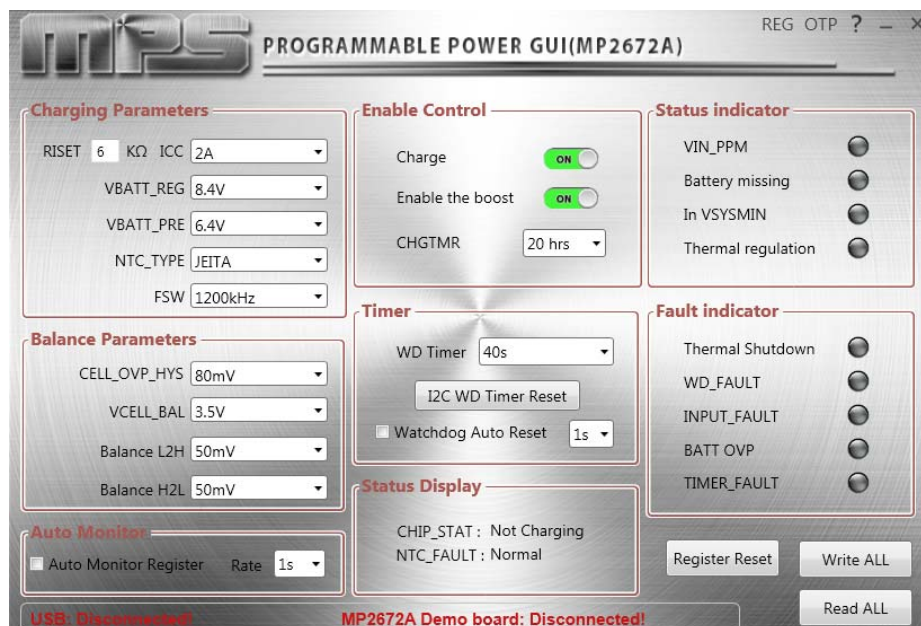
**Figure 4: Main Software Window**



**Procedure**

1. Ensure that all the connections are normal (the USB is connected and the EV2672A-D-00A is connected). If all the connections are successful, the user can run the program (see Figure 5).
2. Turn the DC source on. It should be ready to run the MP2672A in boost charge (see Figure 5).

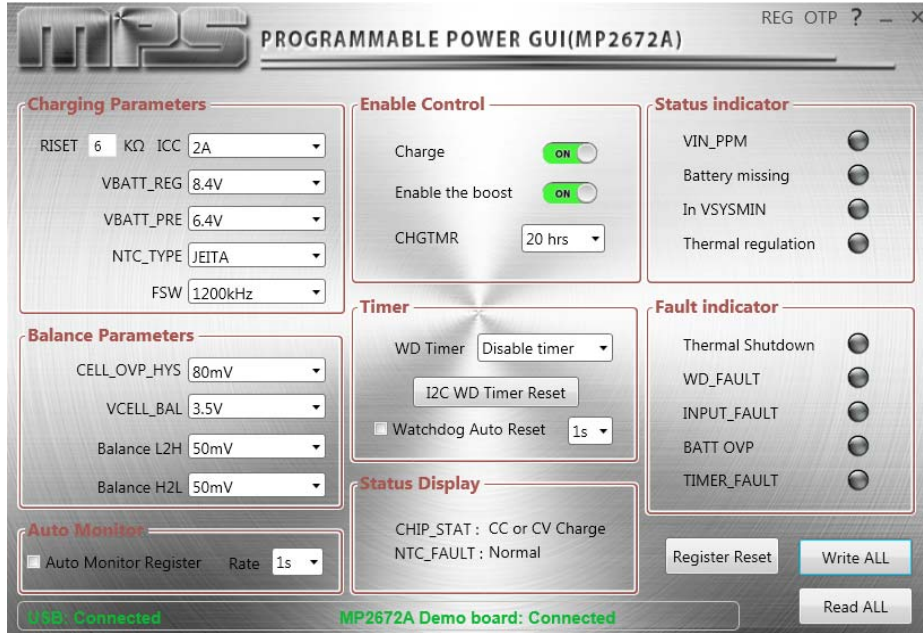

**Figure 5: Successful Demo Board Connection**

3. Configure charging parameters such as the charge current, battery-full voltage, constant charge timer, and NTC type (see Figure 6).

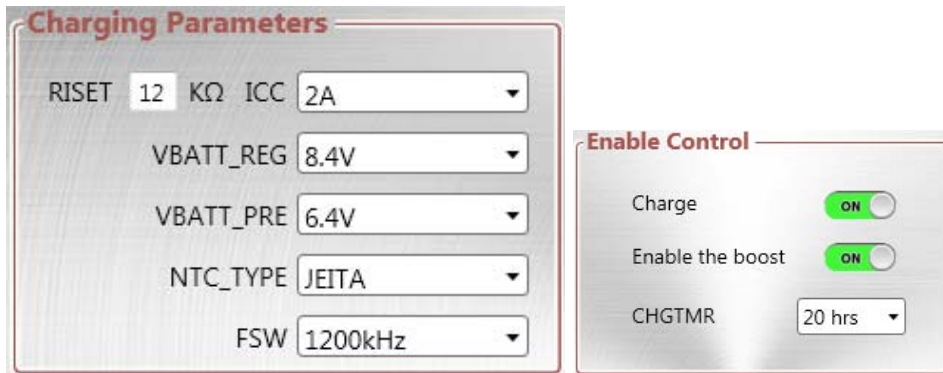

**Figure 6: Charging Parameters**

4. Set the balance parameters (see Figure 7)

For cell-balance control, connect PMID to the middle pin of the 2-cell battery pack (or 2-battery simulator in series), then check the battery cell balance function (see Figure 7).

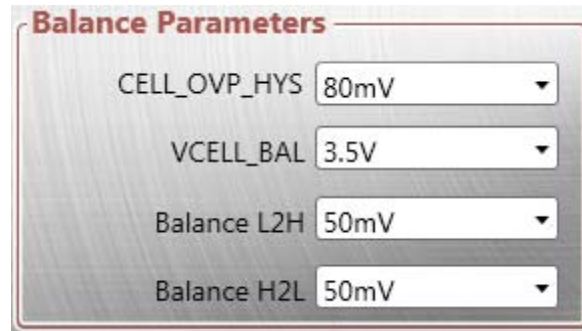

Figure 7: Balance Parameters

- Monitor the registers to obtain the MP2672A’s operation status and fault report (see Figure 7).

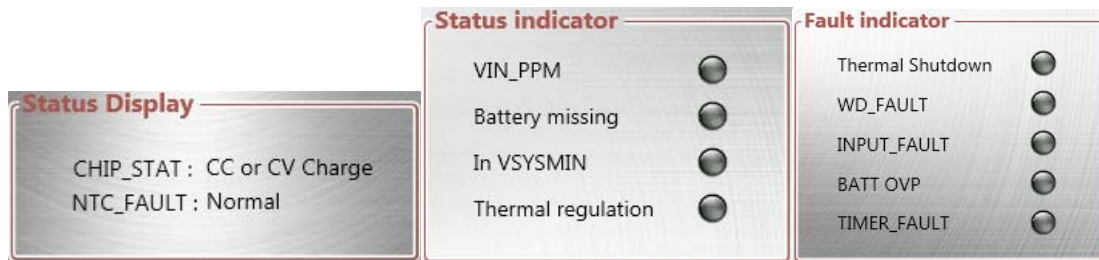

Figure 8: Status and Fault Report for the MP2672A

- To select the I<sup>2</sup>C watchdog timer limit, click “Watchdog Auto Reset” enable watchdog control and run the program automatically.

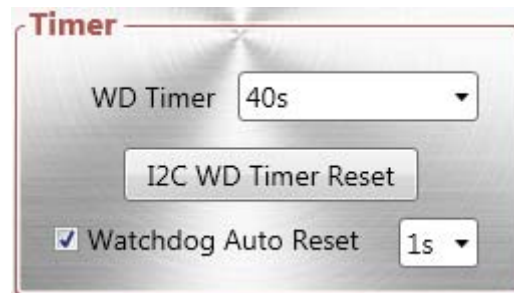

Figure 9: Setting the Watchdog Timer Limit

- The resistor auto-monitor can also be set using this program (see Figure 10).

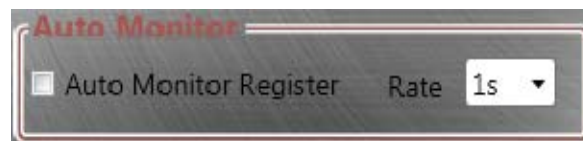

Figure 10: Resistor Auto-Monitor

# EVALUATION BOARD SCHEMATIC

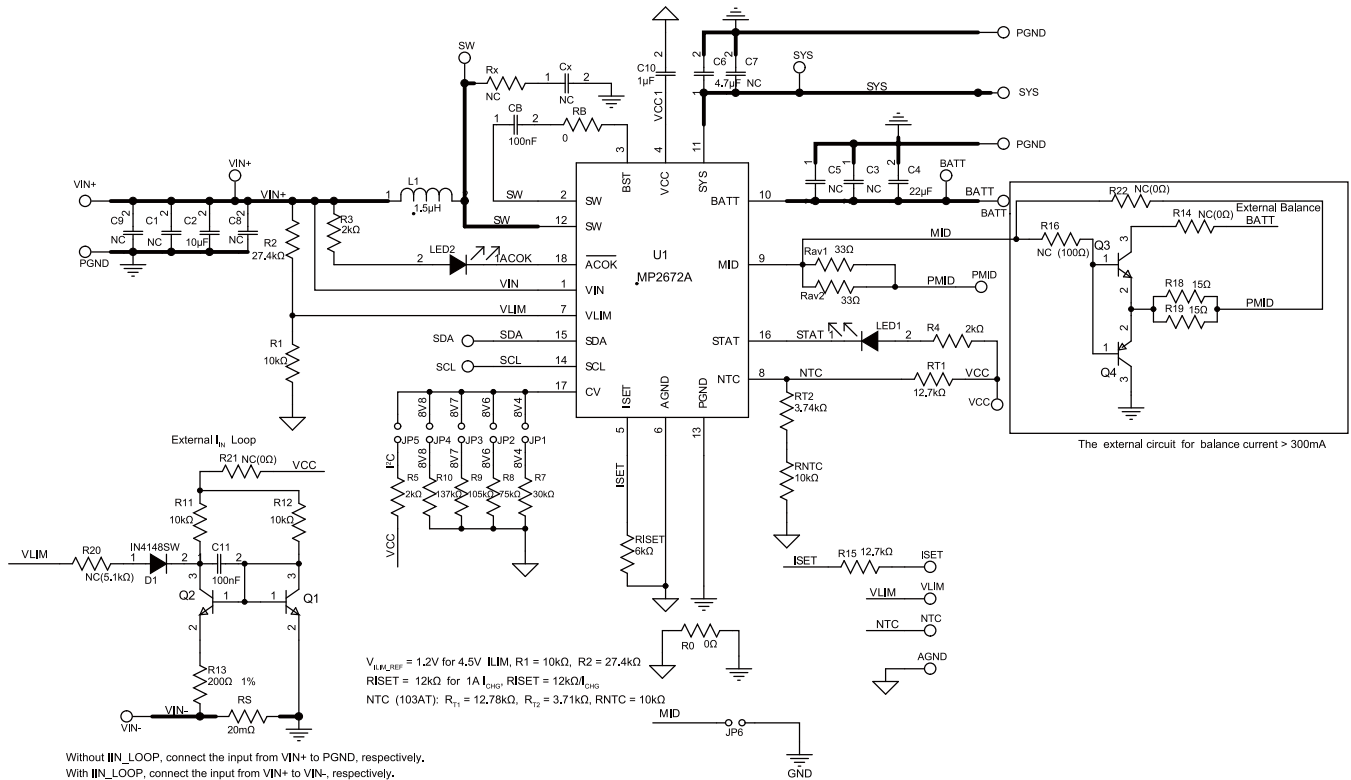

Figure 11: Evaluation Board Schematic (1) (2) (3)

**Notes:**

- 1) Follow the steps below to enable the cell balance function:
  - a) Connect PMID to the middle pin of the 2-cell battery pack to enable the cell balance function.
  - b) External cell balancing is active if R16 = 100Ω, and R12 = R14 = 0Ω.
  - c) Connect PMID to GND to disable the cell balance function.
- 2) Follow the steps below to enable the external input current limit loop:
  - a) Set R20 = 5.1kΩ, and set R21 = 0Ω.
  - b) Connect the cathode of the input power to VIN-.
- 3) Table 1 and Table 2 show how the jumper connections can alter the device.



**EV2672A-D-00B BILL OF MATERIALS**

Qty	Ref	Value	Description	Package	Manufacturer	Manufacturer P/N
1	C1	NC	Capacitor, 16V, X7R	0805	Murata	GRM21BR61C106KE15
1	C2	10 $\mu$ F	Capacitor, 16V, X7R	0805	Murata	GRM21BR61C106KE15
2	C3, C5	NC	Capacitor, 16V, X5R	0805	Murata	GRM21BR61E226ME44L
1	C4	22 $\mu$ F	Capacitor, 16V, X5R	1206	Murata	GRM31CR61C226KE15L
1	C6	4.7 $\mu$ F	Capacitor, 16V, X5R	0805	Murata	GRM21BR61C475KA88L
3	C8, C9, Cx	NC	Capacitor, 16V, X7R	0603	Any	
1	C10	1 $\mu$ F	Ceramic capacitor, 6.3V, X7R	0603	Murata	GRM188R71C105KA12D
2	C11, CB	100nF	Ceramic capacitor, 25V, X7R	0603	Murata	GCJ188R71H104KA12D
1	D1	IN4148W	75V, 0.15A	SOD-123	Diodes	IN4148W
1	L1	1.5 $\mu$ H	Inductor, 1.5 $\mu$ H, 10m $\Omega$ , 14A	SMD	Würth	744311150
1	LED2	BL-HUF35A-TRB	Red light LED	0805	Hongbai	BL-HUF35A-TRB
1	LED1	BL-HGE35A-AV-TRB	Blue light LED	0805	Hongbai	BL-HGE35A-AV-TRB
3	Q1, Q2, Q3	S8050	Transistor, 25V, 0.5A	SOT-23	Fairchild	S8050
1	Q4	S8550	Transistor, PNP, 40V, 200mA	SOT-23	Fairchild	S8550
3	R0, RB, R21	0 $\Omega$	Film resistor, 5%	0603	Yageo	RTT03000JTP
4	R1, R11, R12, RNTC	10k $\Omega$	Film resistor, 1%	0603	Yageo	RC0603FR-0710KL
1	R2	27.4k $\Omega$	Film resistor, 1%	0603	Yageo	RC0603FR-0727K4L
3	R3, R4, R5	2k $\Omega$	Film resistor, 1%	0603	Yageo	RC0603FR-072KL
1	R7	30k $\Omega$	Resistor, 1%	0603	Yageo	RC0603FR-0730KL
1	R8	75k $\Omega$	Film resistor, 1%	0603	Yageo	RC0603FR-0775KL
1	R9	105k $\Omega$	Film resistor, 1%	0603	Yageo	RC0603FR-07105KL
1	R10	137k $\Omega$	Film resistor, 1%	0603	Yageo	RC0603FR-07137KL
1	R13	200 $\Omega$	Film resistor, 1%	0603	Yageo	RC0603FR-07200RL
2	R15, RT1	12.7k $\Omega$	Film resistor, 1%;	0603	Yageo	RC0603FR-0712K7L
2	R18, R19	20 $\Omega$	Film resistor, 1%	1206	Yageo	RC1206FR-0720RL
2	Rav1, Rav2	20 $\Omega$	Resistor, 1%	1206	Yageo	RC1206FR-0720RL
1	RISET	6.04k $\Omega$	Film resistor, 1%	0603	Yageo	RC0603FR-076K04L
1	RS	20m $\Omega$	Film resistor, 1%, 1W	2512	Yageo	RL2512FK-070R02L
1	RT2	3.74k $\Omega$	Film resistor, 1%	0603	Yageo	RC0603FR-073K74L
1	Rx	NC	Film resistor, 5%	0603	Any	

**EV2672A-D-00B BILL OF MATERIALS (continued)**

Qty	Ref	Value	Description	Package	Manufacturer	Manufacturer P/N
1	R16	NC	Film resistor, 5%, 100Ω	0603	Any	
2	R14, R22	NC	Film resistor, 1%, 0Ω	0603	Any	
1	R20	NC	Film resistor, 1%, 5.1kΩ	0603	Any	
1	U1	MP2672AG D-000E	2-cell switching NVDC boost charger with cell balance function	QFN-18 (2mmx3mm)	MPS	MP2672AGD-xxxx
7	BATT, GND, VIN+, GND, VIN-, SYS, GND	2.0mm	Connector		Any	
4	VIN+, SW, SYS, BATT	1.0mm	Test point		Any	
6	PMID, VLIM, AGND, ISET, NTC, VCC	2.54mm	Test point		Any	
6	JP1, JP2, JP3, JP4, JP5, JP6	2.54mm	Connector		Any	
2	JP5, JP6	2.54mm	Shorter		Any	
1	EV2672A-D-00B		PCB evaluation board			

## EVB TEST RESULTS

Performance curves and waveforms are tested on the evaluation board.  $V_{IN} = 5V$  (5A),  $V_{IN\_MIN} = 4.5V$ ,  $V_{BATT\_PRE} = 6.5V$ ,  $I_{CC} = 2A$ ,  $V_{BATT} = 0V$  to  $8.4V$ ,  $C_{IN} = 10\mu F$ ,  $C_{SYS} = 4.7\mu F$ ,  $C_{BATT} = 22\mu F$ ,  $f_{SW} = 1200kHz$ ,  $T_A = 25^\circ C$ , unless otherwise noted.

### Constant Current Charge Efficiency

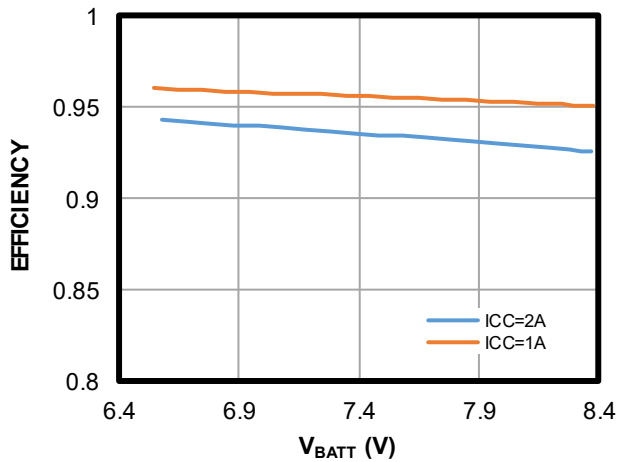

### Constant Voltage Efficiency

BATT = 8.4V

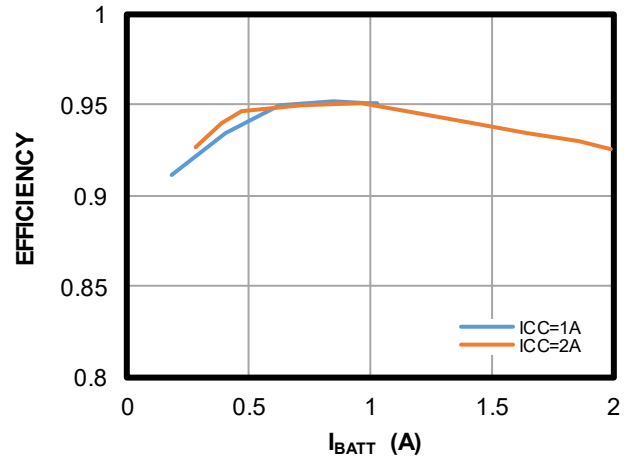

### $I_{CC}$ vs. $R_{ISET}$

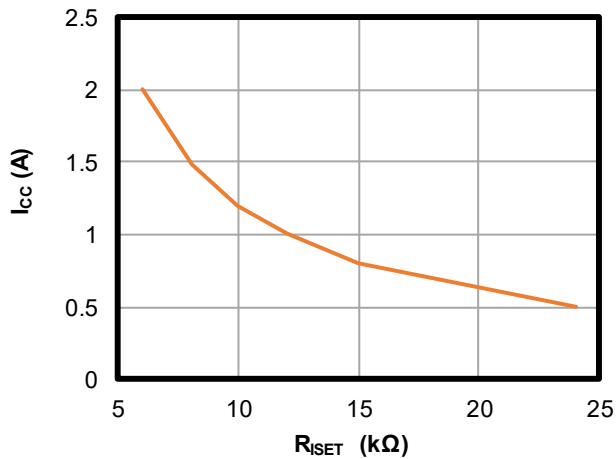

## EVB TEST RESULTS (continued)

Performance curves and waveforms are tested on the evaluation board.  $V_{IN} = 5V$  (5A),  $V_{IN\_MIN} = 4.5V$ ,  $V_{BATT\_PRE} = 6.5V$ ,  $I_{CC} = 2A$ ,  $V_{BATT} = 0V$  to  $8.4V$ ,  $C_{IN} = 10\mu F$ ,  $C_{SYS} = 4.7\mu F$ ,  $C_{BATT} = 22\mu F$ ,  $f_{SW} = 1200kHz$ ,  $T_A = 25^\circ C$ , unless otherwise noted.

### Battery Charge Curve

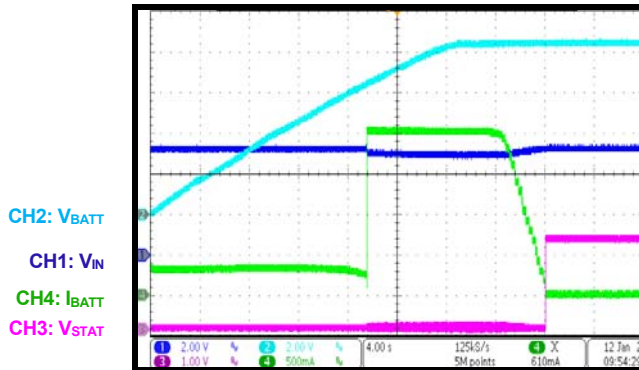

### Auto-Recharge

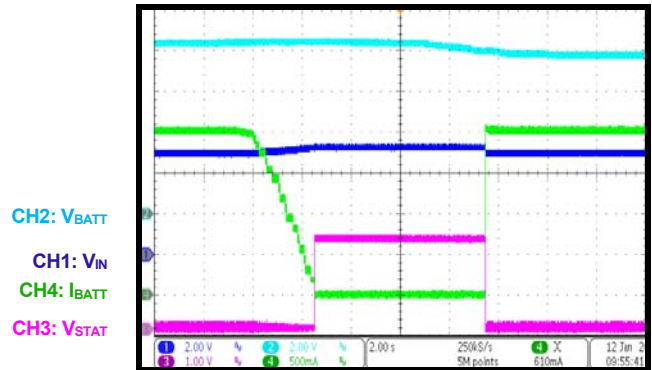

### Pre-Charge Steady State

$V_{BATT} = 5V$

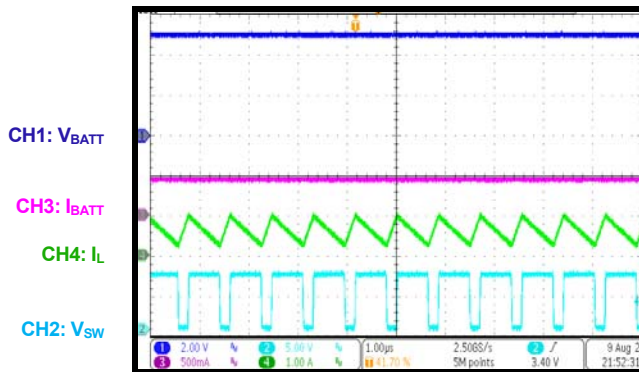

### Constant Current Charge Steady State

$V_{BATT} = 7.4V$

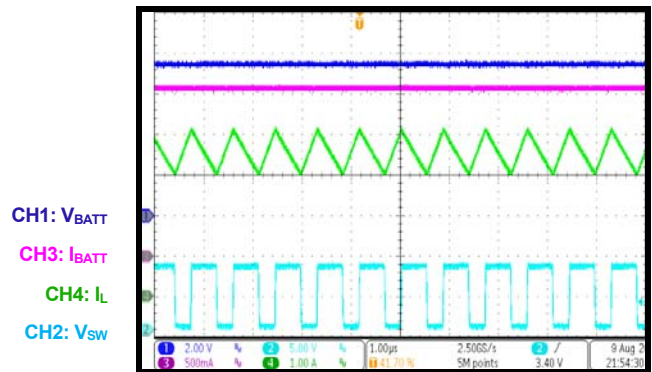

### Constant Current Charge Steady State

$V_{BATT} = 8.4V/1A$

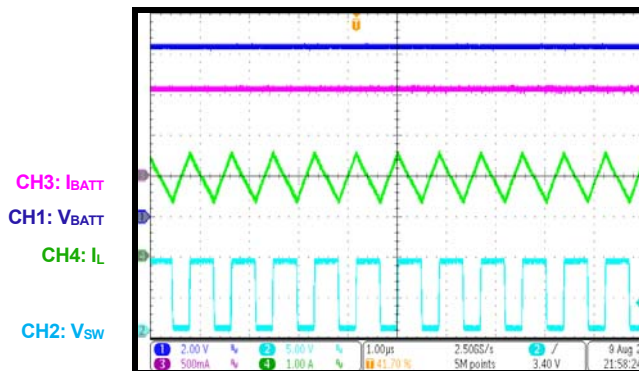

### Constant Current Charge Steady State

$V_{BATT} = 8.4V/0.5A$

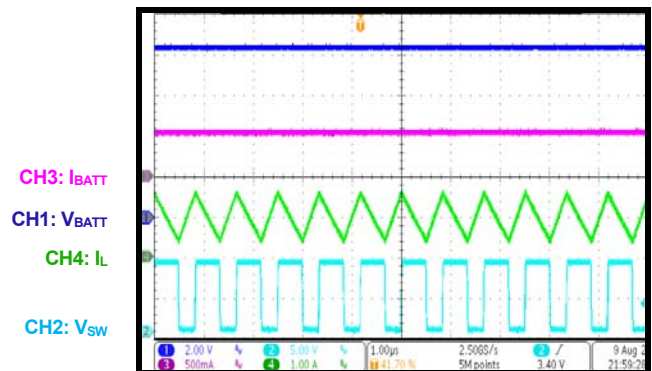

### EVB TEST RESULTS (continued)

Performance curves and waveforms are tested on the evaluation board.  $V_{IN} = 5V$  (5A),  $V_{IN\_MIN} = 4.5V$ ,  $V_{BATT\_PRE} = 6.5V$ ,  $I_{CC} = 2A$ ,  $V_{BATT} = 0V$  to  $8.4V$ ,  $C_{IN} = 10\mu F$ ,  $C_{SYS} = 4.7\mu F$ ,  $C_{BATT} = 22\mu F$ ,  $f_{SW} = 1200kHz$ ,  $T_A = 25^\circ C$ , unless otherwise noted.

#### Start-Up through VIN

$V_{BATT} = 7.4V$

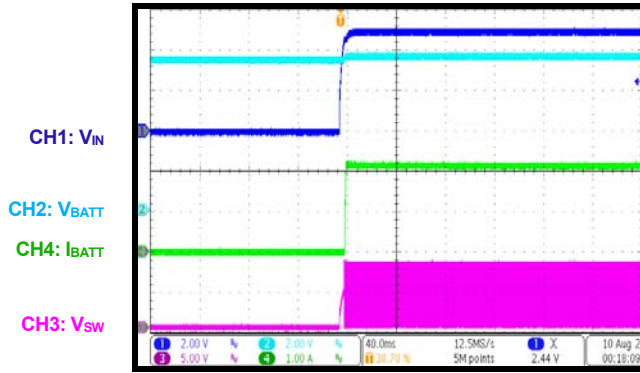

#### Shutdown through VIN

$V_{BATT} = 7.4V$

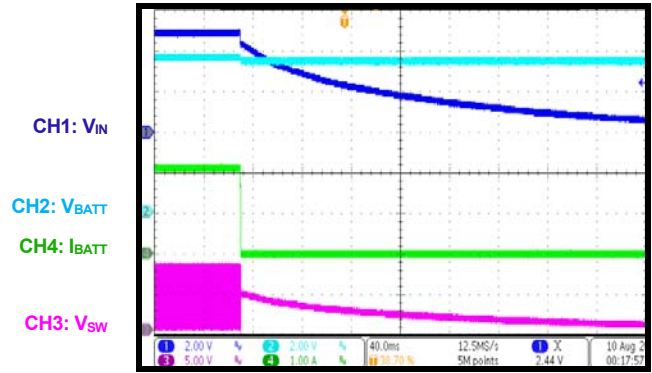

#### Cell Balance

$I_{CC} = 1A$ ,  $H_{cell} = 3.6V$  and  $L_{cell} = 3.8V$ , enable balance, balance resistor is  $17m\Omega$

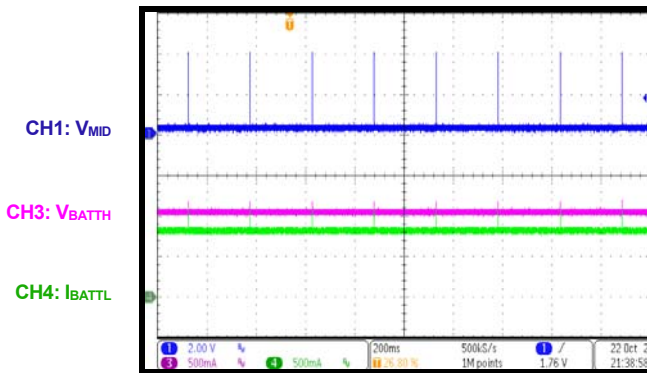

#### Cell Balance

$I_{CC} = 1A$ ,  $H_{cell} = 3.8V$  and  $L_{cell} = 3.6V$ , enable balance, balance resistor is  $17m\Omega$

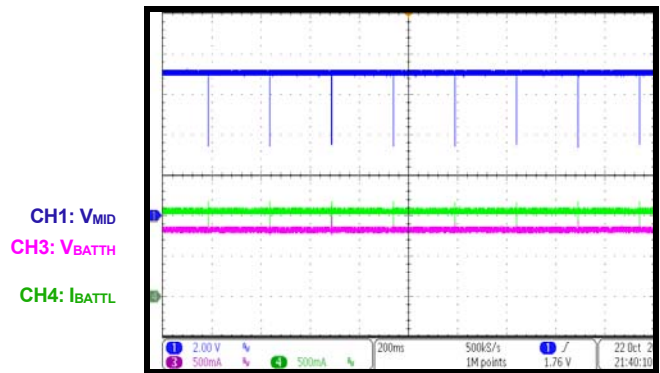

#### Standard NTC Protection

$V_{BATT} = 7.4V$

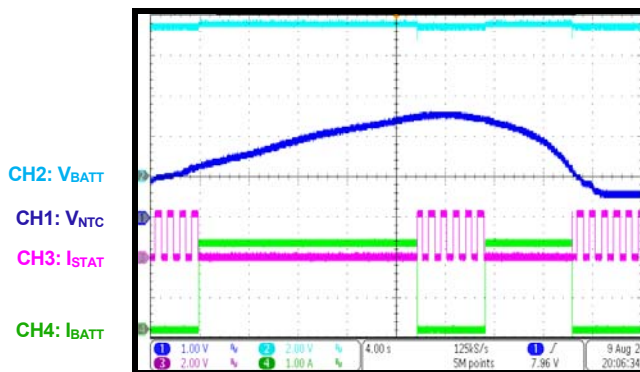

#### JEITA NTC Protection

$V_{BATT} = 8.15V$

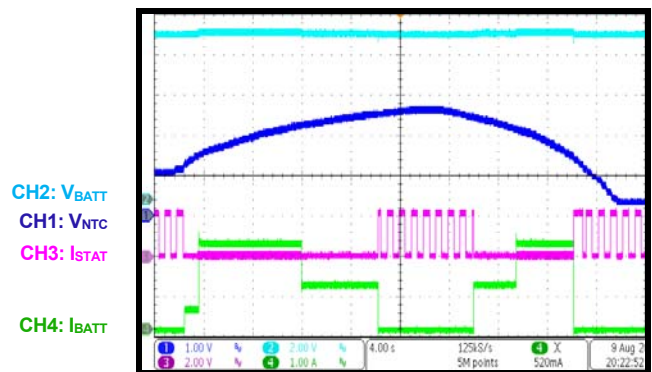

### PCB LAYOUT

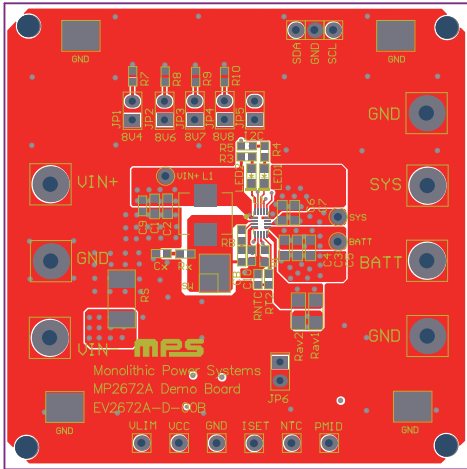

Figure 12: Top Layer

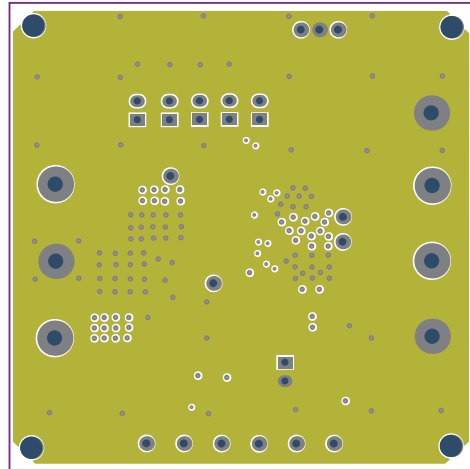

Figure 13: Mid-Layer 1

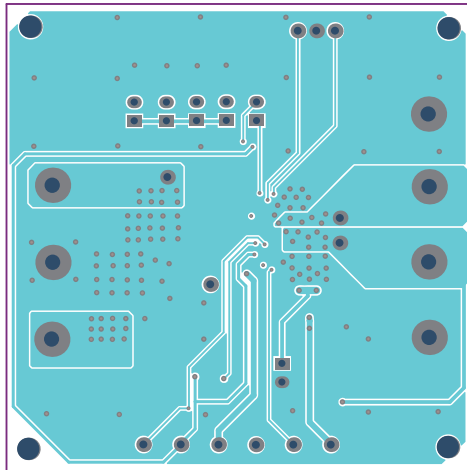

Figure 14: Mid-Layer 2

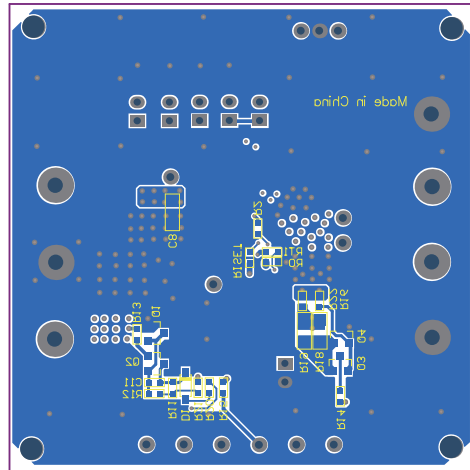

Figure 15: Bottom Layer



## Revision History

Revision #	Revision Date	Description	Pages Updated
1.0	12/2/2020	Initial Release	-

**Notice:** The information in this document is subject to change without notice. Users should warrant and guarantee that third-party Intellectual Property rights are not infringed upon when integrating MPS products into any application. MPS will not assume any legal responsibility for any said applications.