

DESCRIPTION

The EV2661-C-00A is an evaluation board for the MP2661, a highly-integrated single-cell Li-Ion/Li-Polymer battery charger with system power path management, targeted at space limited portable applications. It takes input power from either an AC adapter or a USB port to supply the system load and charge the battery independently. The charger section features trickle charge, constant current (CC) and constant voltage (CV) regulation, charge termination and charge status.

EV2661 ensures the continuous power to the system by automatically selecting the input, the battery or both to power the system.

EV2661 provides system short circuit protection to prevent the Li-Ion battery from being damaged due to excessive high current.

EV2661 cuts off the path between battery and system when battery UVLO to prevent the Li-Ion battery from being overly discharged.

Through the I2C connector on EV2661, the customer can program the charging parameters, such as: input current limit, input voltage regulation limit, charging current, battery regulation voltage, and battery UVLO.

ELECTRICAL SPECIFICATION

Parameter	Symbol	Value	Units
Input Voltage	V_{IN}	4.6 - 5.5	V
Battery Voltage	V_{BATT}	3.60 - 4.545	V
Input Current Limit	I_{IN} Limit	85 - 455	mA
V_{IN} Regulation Voltage	V_{IN} Limit	$V_{BATT}+400mV$	V
Charge Current	I_{CHG}	8 - 535	mA
Discharge Current	I_{DSG}	400 - 3200	mA

FEATURES

- Fully Autonomous Charger for Single-Cell Li-Ion/Polymer Batteries
- Current Limit for USB Port
- Complete Power Path Management for Simultaneously Powering the System and Charging the Battery
- 0.5% Charging Voltage Accuracy
- 12V Maximum Voltage for the Input Source
- I²C Interface for Setting charging Parameters and Status Reporting
- Robust Charging Protection Including Battery Temperature Monitor and Programmable Timer
- Battery Disconnection Function

APPLICATIONS

- Wearable devices
- Smart Handheld Devices
- Fitness Accessories
- Smart Watches

All MPS parts are lead-free, halogen free, and adhere to the RoHS directive. For MPS green status, please visit MPS website under Quality Assurance. "MPS" and "The Future of Analog IC Technology" are Registered Trademarks of Monolithic Power Systems, Inc.

EV2661-C-00A EVALUATION BOARD



(L x W x H) 2.5" x 2.5" x 0.063"
(6.35cm x 6.35cm x 0.16cm)

Board Number	MPS IC Number
EV2661-C-00A	MP2661GC-xxxx*

*: "xxxx" is the register setting option. The factory default is "0000". This content can be viewed in I²C register map. For customer options, please contact an MPS FAE to obtain a "XXXX" value.

EVALUATION BOARD SCHEMATIC

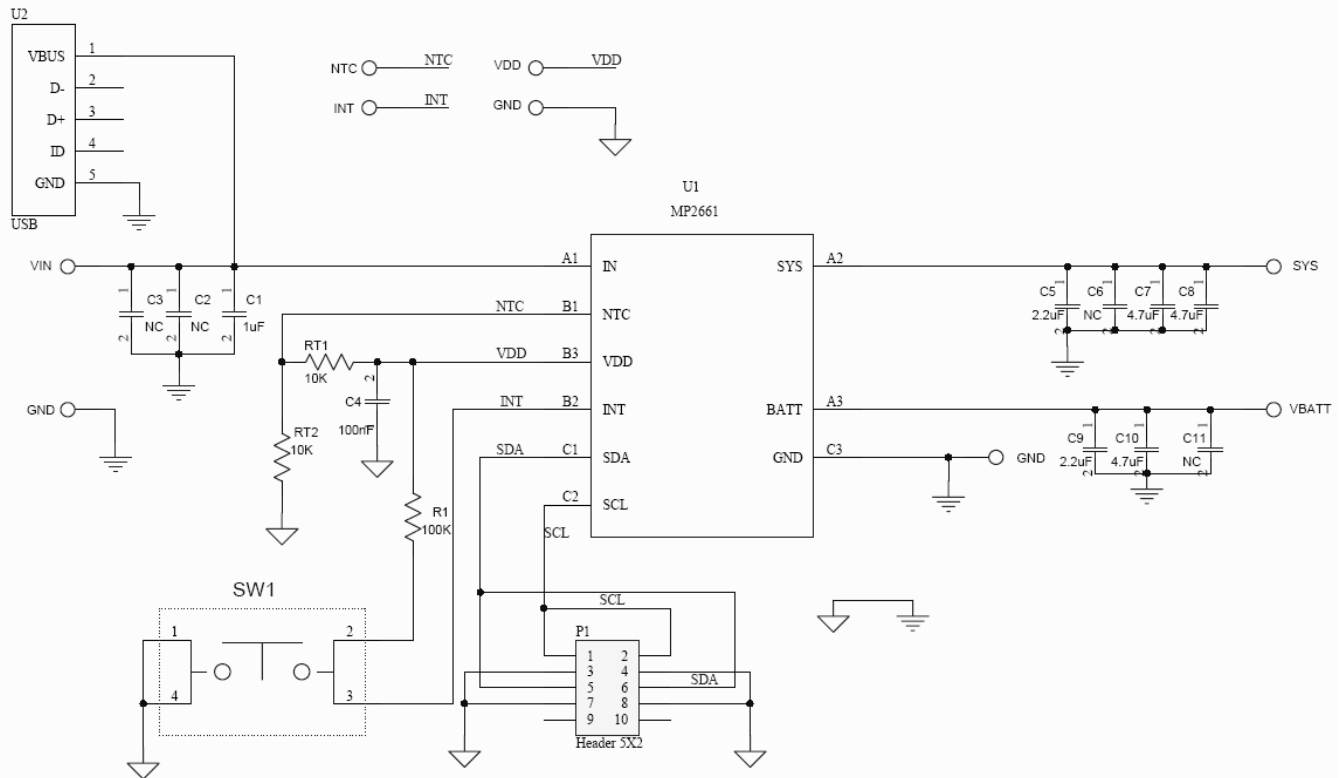

EV2661-C-00A BILL OF MATERIALS

Qty	Ref	Value	Description	Package	Manufacturer	Part Number
1	C1	1 μ F	Ceramic Cap;25V; X7R;0603;	0603	muRata	GRM188R71E105KA12D
2	C5, C9	2.2 μ F	Ceramic Cap;25V; X7R;0805;	0805	muRata	GRM21BR71E225KA73L
1	C2	NC	Ceramic Cap;25V; X7R;0805;	0805	muRata	GRM21BR71E225KA73L
3	C7, C8, C10	4.7 μ F	Ceramic Cap;25V; X7R;1206	1206	muRata	GRM31CR71E475KA88L
1	C4	100nF	Ceramic Cap;25V; X7R;0805;	0805	HHEC	C0805X104K025T
1	C6	NC	Ceramic Cap;25V; X7R;0805;	0805	muRata	GRM21BR71E225KA73L
2	C3, C11	NC	Ceramic Cap;25V; X7R;1206	1206	muRata	GRM31CR71E475KA88L
1	P1		Header, 5-Pin, Dual row			
1	R1	100k	Film Resistor;1%;	0603	Yageo	RC0603FR-07100KL
2	RT1, RT2	10k	Film Resistor;1%;	0603	Yageo	RC0603FR-0710KL
1	U2		Micro-B USB connector;			
1	U1	IC	MP2661GC-0000	WCSP 1.55mm* 1.55mm	MPS	MP2661GC-0000

PRINTED CIRCUIT BOARD LAYOUT

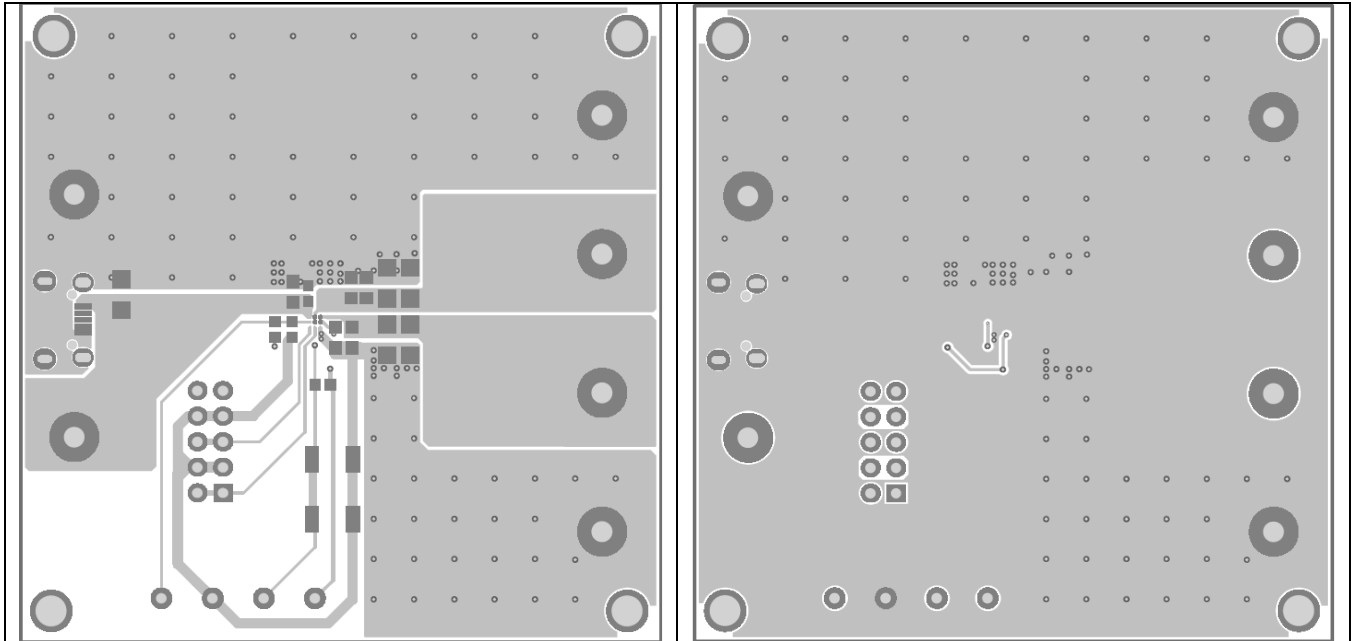

Figure1 Top Layer

Figure2 Bottom Layer

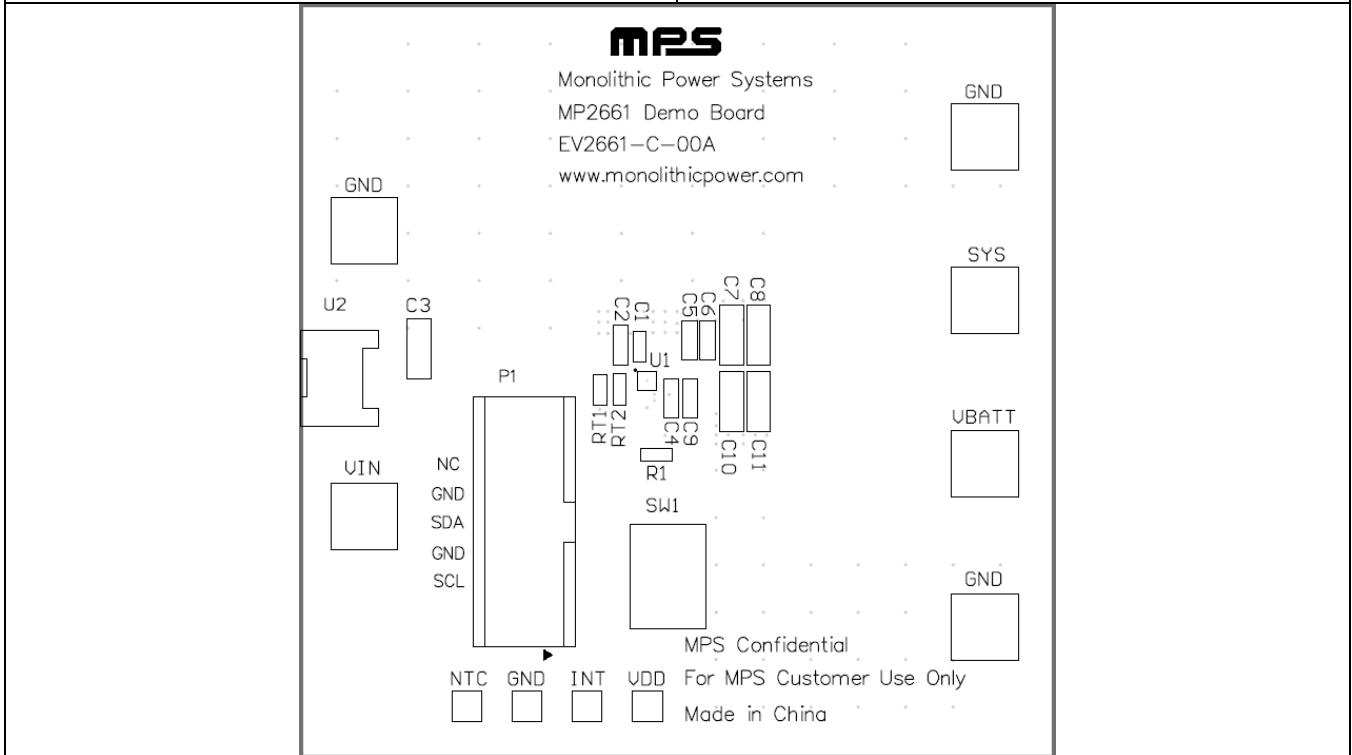

Figure3 Top Silk Layer

QUICK START GUIDE

This board is designed for MP2661 which is a highly-integrated single-cell Li-Ion/Li-Polymer battery charger with system power path management function. And layout accommodates most commonly used capacitors. The default function of this board is preset for charger mode and the charge full voltage is preset to 4.200V for 1 cell Li-Ion battery.

Evaluation Platform Preparation:

1) USB-to-I²C Communication Kit

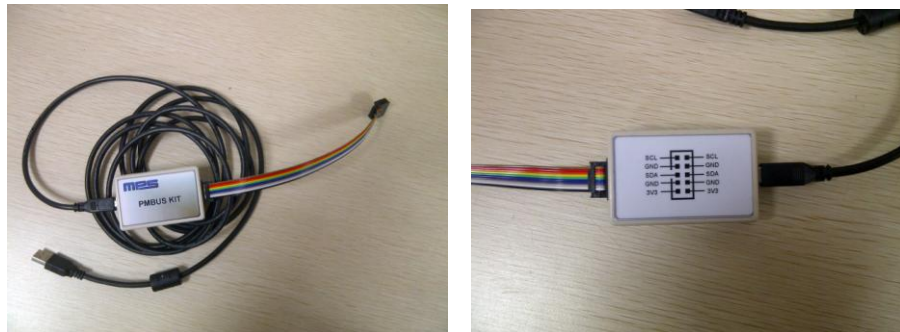

Figure4 USB-to-I²C Communication Kit

2) Software - double-click on the MP2661 Evaluation Kit_R0.6.EXE file and open the software. The software supports the Windows® XP operating systems.



3) A computer with at least one USB port and a USB cable. The MP2661 evaluation software must be properly installed.

4) Original Test Setup for MP2661 in Figure5

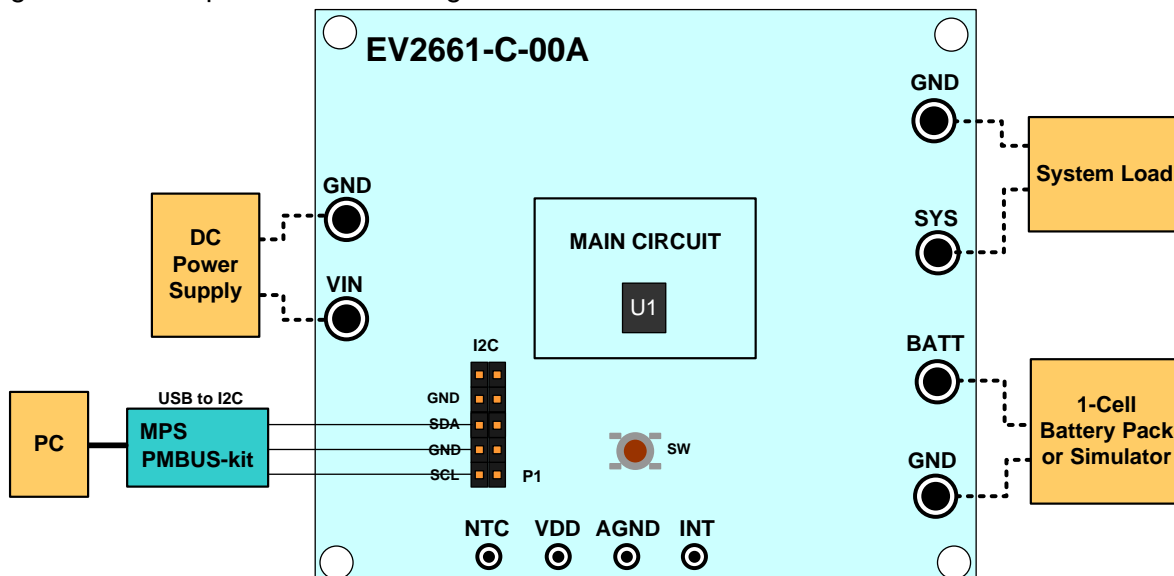

Figure5 Test Setup for MP2661

5) Turn on the computer. Launch the MP2661 evaluation software. The main window of the software is shown in Figure 6.

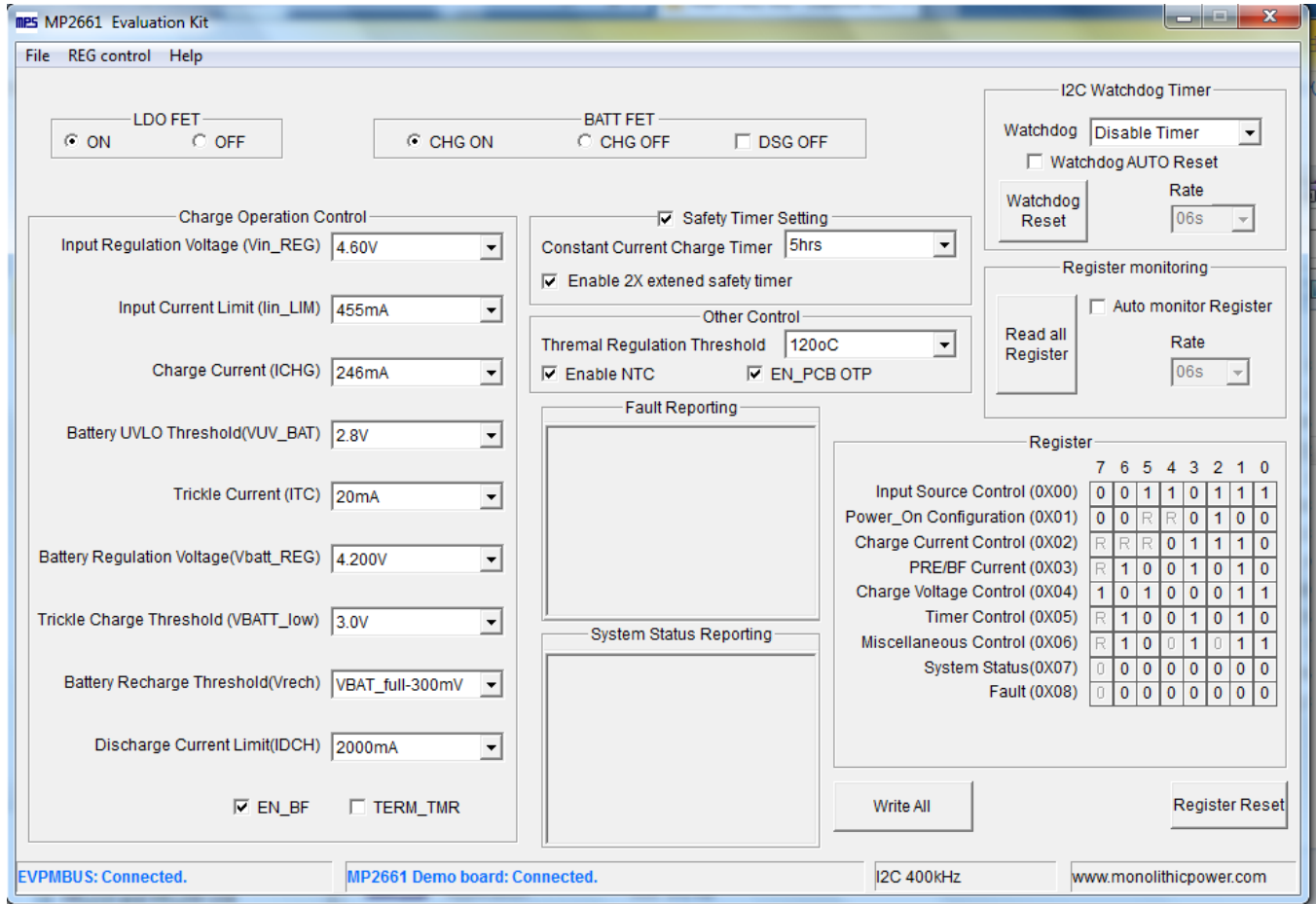

Figure6 MP2661evaluation software

Procedure

Make sure all the connections are normal -- the EVPMBUS connected and EV2661-C-00A connected. It is ready to run the program!

Charger Function

Charge Operation Control

Input Regulation Voltage (Vin_REG)

Input Current Limit (Iin_LIM)

Charge Current (ICHG)

Battery UVLO Threshold(VUV_BAT)

Trickle Current (ITC)

Battery Regulation Voltage(Vbatt_REG)

Trickle Charge Threshold (VBATT_low)

Battery Recharge Threshold(Vrech)

charge Current Limit(IDCH)

EN_BF TERM_TMR

1. Set Input Voltage Regulation at 4.60 V (the range is 3.88 - 5.08V)

Input Regulation Voltage (Vin_REG)

4.36V

4.44V

4.52V

4.60V

4.68V

4.76V

4.84V

2. Set Input Current Limit to 455 mA (the range is 85 – 455mA)

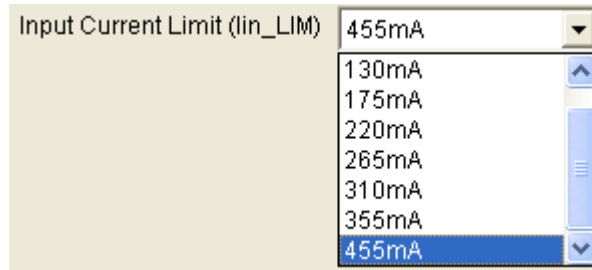

3. Set Constant Charge Current, ICHG to 246 mA (the range is 8 – 535mA)

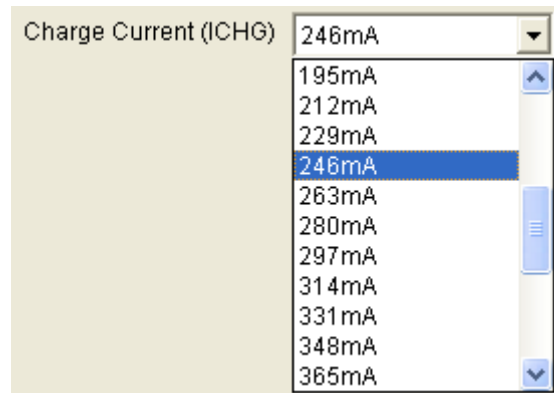

4. Set BATT UVLO threshold to 2.8V (the range is 2.4 – 3.1V)

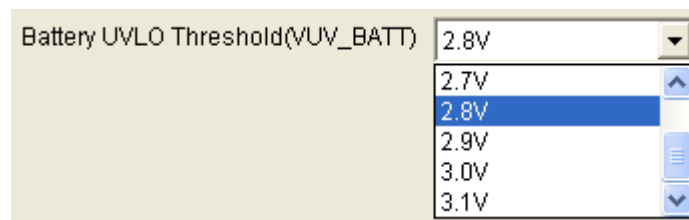

5. Set Trickle Current to 20 mA (the range is 6 – 27mA)

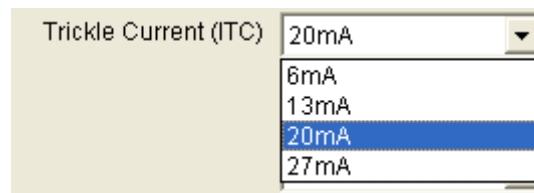

6. Set Charge Full Voltage to 4.200 V (the range is 3.6 - 4.545V)

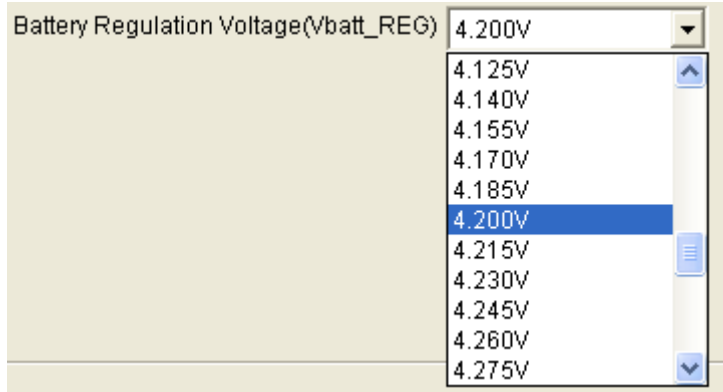

7. Set Trickle - Charge to CC Charge Threshold Voltage to 3.0 V (the range is 2.8 – 3.0V)

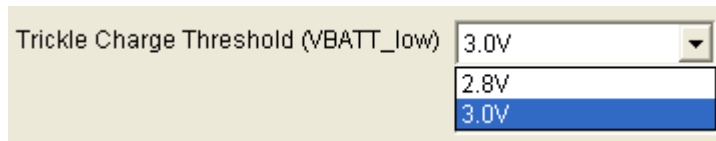

8. Set Battery auto recharge Voltage to VBATT_Full – 300mV (the range is 150mV or 300mV)

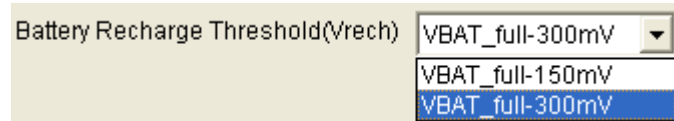

9. Set battery discharge current limit to 2A (the range is 400mA to 3200mA):

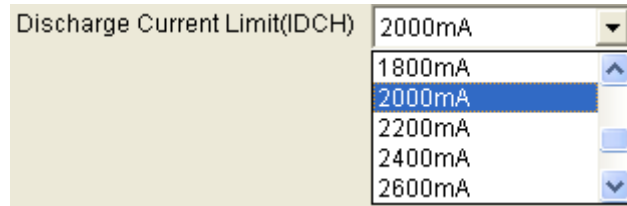

10. Termination Function Select

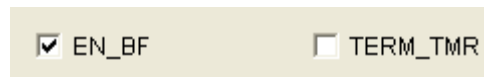

Table 1 Termination Function Selection Table

EN_BF	TERM_TMR	After I _{BATT} hit I _{BF} in CV mode	
		Operation	Charge Status
<input type="checkbox"/>	x	Keep CV Charge	Charge
<input checked="" type="checkbox"/>	<input type="checkbox"/>	Charge Done	Charge Done
<input checked="" type="checkbox"/>	<input checked="" type="checkbox"/>	Keep CV Charge	Charge Done

Others

1. LDO FET Control:

This bit only controls the on/off of the LDO FET.

2. BATT FET Control:

CHG ON and CHG OFF only control the on/off of the Battery FET in charge mode.

DSG OFF selected could turn off the Battery FET at both charge and discharge mode.

DSG OFF unselected could not turn on Battery FET; pull INT to low by push button could turn on Battery FET when it's turned off by DSG OFF.

3. Other Control.

Above setting enables PCB OTP; for other application, please refer to the table below.

Table 2 NTC Function Selection Table

Enable NTC	EN_PCB OTP	Function
<input type="checkbox"/>	x	Disable
<input checked="" type="checkbox"/>	<input type="checkbox"/>	NTC
<input checked="" type="checkbox"/>	<input checked="" type="checkbox"/>	PCB OTP

4. Safety Timer Setting

5. I²C Watchdog Timer

6. Resister Auto Monitor

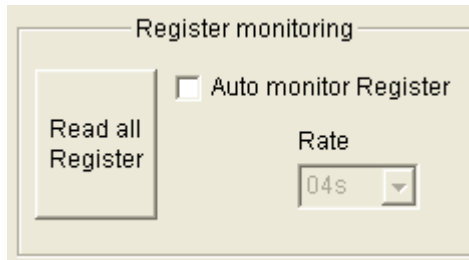

7. Content of the Registers:

Register	7	6	5	4	3	2	1	0
Input Source Control (0X00)	0	0	1	1	0	1	1	1
Power_On Configuration (0X01)	0	0	R	R	0	1	0	0
Charge Current Control (0X02)	R	R	R	0	1	1	1	0
PRE/BF Current (0X03)	R	1	0	0	1	0	1	0
Charge Voltage Control (0X04)	1	0	1	0	0	0	1	1
Timer Control (0X05)	R	1	0	0	1	0	1	0
Miscellaneous Control (0X06)	R	1	0	0	1	0	1	1
System Status(0X07)	0	0	0	0	0	0	0	0
Fault (0X08)	0	0	0	0	0	0	0	0

8. Monitor the MP2661 operation status and Fault report

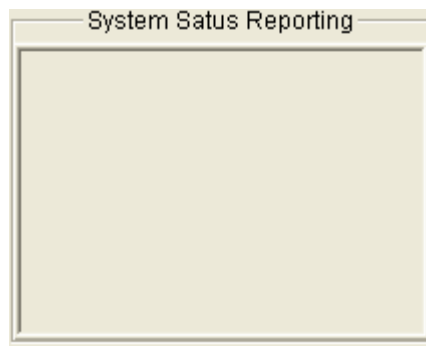
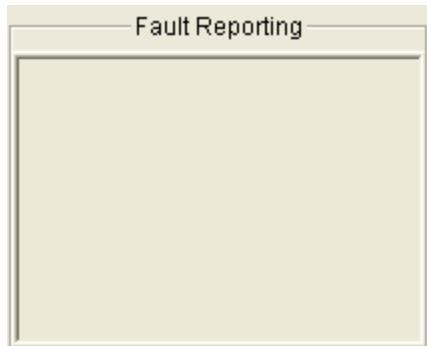

❖Notes❖

- For the other detailed description on the operation of this part, please contact local FAE to apply the latest datasheet

NOTICE: The information in this document is subject to change without notice. Please contact MPS for current specifications. Users should warrant and guarantee that third party Intellectual Property rights are not infringed upon when integrating MPS products into any application. MPS will not assume any legal responsibility for any said applications.