



EV2615D-Q-00A

18V, 1A, 4.05V or 4.13V V_{BATT} , Single-Cell, Lithium-Ion Battery Charger Evaluation Board

DESCRIPTION

The EV2615D-Q-00A is an evaluation board designed to demonstrate the capabilities of the MP2615D, a monolithic switching charger with integrated power MOSFETs designed for single-cell lithium-ion or lithium-polymer batteries.

It can achieve up to 2A of charge current across a 4.5V to 18V input voltage (V_{IN}) range. The charge current can be configured via an accurate current-sense resistor.

The MP2615D regulates the charge current (I_{CHG}) and battery voltage (V_{BATT}) with two control loops to enable high-accuracy constant

current (CC) and constant voltage (CV) charging. Constant-off-time (COT) control can achieve a 99% duty cycle once V_{BATT} reaches V_{IN} to maintain a high I_{CHG} .

The battery temperature and charging status are monitored. Two status-monitoring output pins (ACOK and CHGOK) are provided to indicate the battery charge status and input power status. The MP2615D also features internal reverse blocking protection.

The MP2615D is available in a QFN-16 (3mmx3mm) package.

PERFORMANCE SUMMARY

Specifications are at $T_A = 25^\circ\text{C}$, unless otherwise noted.

Parameters	Conditions	Value
Input voltage (V_{IN}) range		4.5V to 18V
Battery voltage (V_{BATT})	$V_{IN} = 4.5\text{V to }18\text{V}$, $I_{BATT} = 0\text{A to }1\text{A}$	$V_{BATT} = 4.05\text{V or }4.13\text{V}$
Maximum output current (I_{BATT})	$V_{IN} = 4.5\text{V to }18\text{V}$	1A
Typical efficiency	$V_{IN} = 5\text{V}$, $V_{BATT} = 3.8\text{V}$, $I_{BATT} = 1\text{A}$	93.7%
Peak efficiency	$V_{IN} = 5\text{V}$, $V_{BATT} = 4.05\text{V}$, $I_{OUT} = 400\text{mA}$	95.4%
Switching frequency	$V_{IN} = 12\text{V}$	1MHz

 Optimized Performance with MPS Inductor MPL-AL5030 Series

EVALUATION BOARD

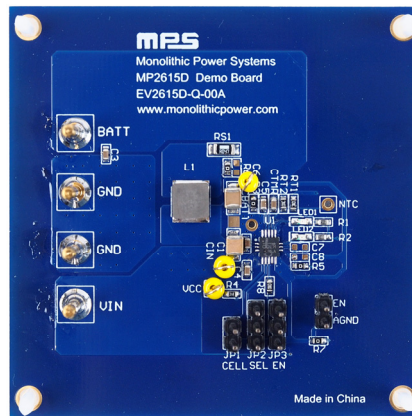

LxWxH (6.3cmx6.3cmx0.16cm)

Board Number	MPS IC Number
EV2615D-Q-00A	MP2615D

QUICK START GUIDE

The EV2615D-Q-00A board layout accommodates most commonly used capacitors.

1. Float the CELL pin or connect CELL to GND via JP1. Do not connect CELL to a high logic voltage.
2. JP2 sets the SEL pin logic, which can regulate the terminal battery voltage (V_{BATT}). Pull SEL high to set the terminal V_{BATT} to 4.13V; float SEL or pull SEL low to set it to 4.05V. Table 1 shows the terminal V_{BATT} specifications set via SEL.

Table 1: Terminal V_{BATT} for Each SEL State

SEL State	Terminal V _{BATT}
High	4.13V
Low or floating	4.05V

3. JP3 sets the EN pin logic, which can shut down the battery charger while an input voltage (V_{IN}) is present. Float EN or connect EN to GND to turn the charger on; pull EN up to VCC via JP3 to turn it off.
4. The current-sense resistor (RS1) sets the constant charge (CC) current (I_{CC}). I_{CC} can be calculated with Equation (1):

$$I_{CC} \text{ (A)} = 47\text{(mV)} / RS1\text{(m}\Omega\text{)} \quad (1)$$

For example, if RS1 is 47mΩ, then I_{CC} is 1A.

5. The trickle charge current (I_{TC}) can be calculated with Equation (2):

$$I_{TC} = 10\% \times I_{CC} = 4.7\text{(mV)} / RS1\text{(m}\Omega\text{)} \quad (2)$$

For more information, refer to the MP2615D's datasheet.

EVALUATION BOARD SCHEMATIC

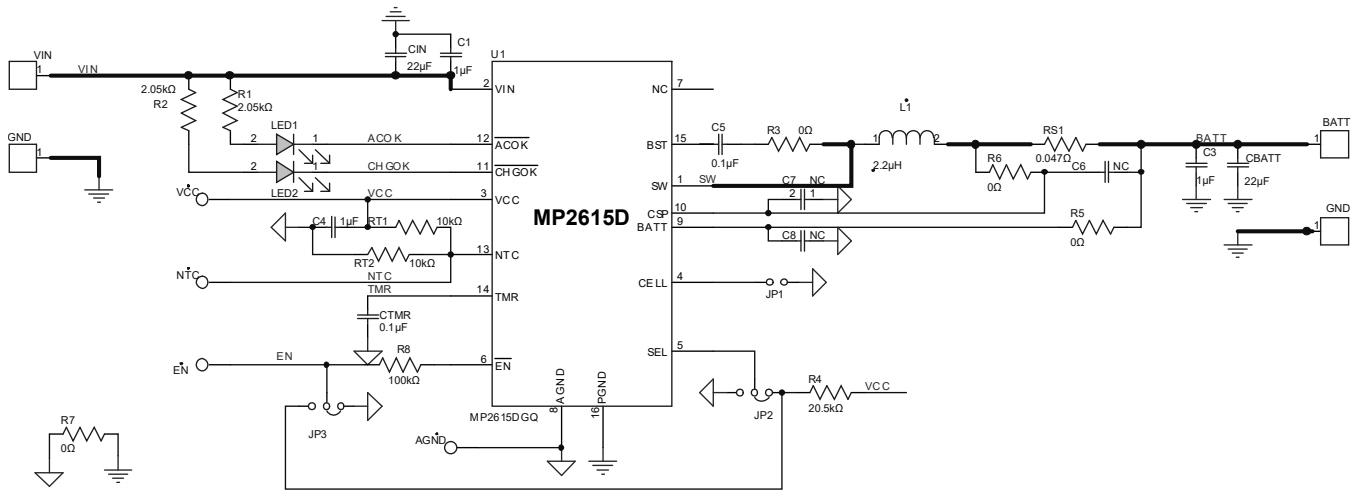

Figure 1: Evaluation Board Schematic

EV2615D-Q-00A BILL OF MATERIALS

Qty	Ref	Value	Description	Package	Manufacturer	Manufacturer PN
4	C1, C3, C4, CTMR	1 μ F	Ceramic capacitor, 25V, X7R, 0603	0603	Murata	GRM188R71E105KA12D
3	C6, C7, C8	NC				
1	C5	0.1 μ F	Ceramic capacitor, 16V, X7R, 0603	0603	Murata	GRM188R71C104KA01D
2	RT1, RT2	10k Ω	Film resistor, 1%	0603	Yageo	RC0603FR-0710KL
2	R1, R2	2.05k Ω	Film resistor, 1%	0603	Yageo	RC0603FR-072K05L
1	R4	20.5k Ω	Film resistor, 1%	0603	Yageo	RC0603FR-0720K5L
4	R3, R5, R6, R7	0 Ω	Film resistor, 5%	0603	Yageo	RC0603JR-070RL
1	R8	100k Ω	Film resistor, 1%	0603	Yageo	RC0603FR-07100KL
1	LED1	Red	LED, red light	0805	Bright LED	BL-HUF35A-TRB
1	LED2	Green	LED, green light	0805	Bright LED	BL-HGB35A-TRB
2	CBATT, CIN	22 μ F	Ceramic capacitor, 25V, X7R	1210	Murata	GRM32ER71E226KE15L
1	RS1	0.047 Ω	Film resistor, 1%, 1/4W	1206	Yageo	RL1206FR-070R05L
1	L1	2.2 μ H	Inductor, 2.2 μ H, 12.3m Ω , 8.2A	SMD	MPS	MPL-AL5030-2R2
1	U1	MP2615D	Switching charger	FCQFN-16 (3mmx3mm)	MPS	MP2615DGQ

EVB TEST RESULTS

Performance curves and waveforms are tested on the evaluation board. V_{IN} = 5V to 18V, V_{BATT} = 4.05V, L = 2.2 μ H (DCR = 12.3m Ω), T_A = 25°C, unless otherwise noted.

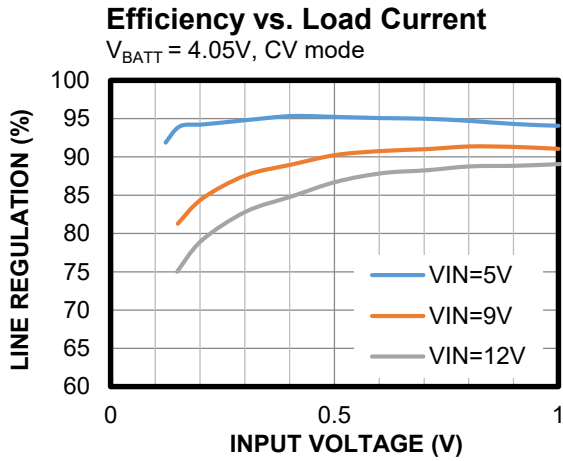

Thermal Performance

V_{IN} = 12V, V_{BATT} = 4.05V, I_{BATT} = 1A, no forced airflow

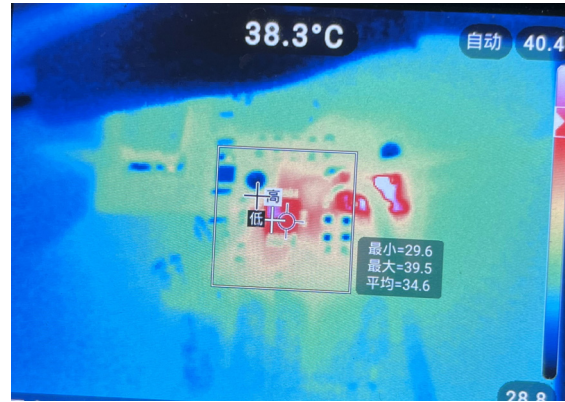

EVB TEST RESULTS (continued)

Performance curves and waveforms are tested on the evaluation board. $V_{IN} = 12V$, $V_{BATT} = 3.8V$, $L = 2.2\mu H$, $R_S = 47m\Omega$, $T_A = 25^\circ C$, SEL = GND, unless otherwise noted.

Battery Charge Curve

$V_{BATT} = 0V$ to $4.05V$

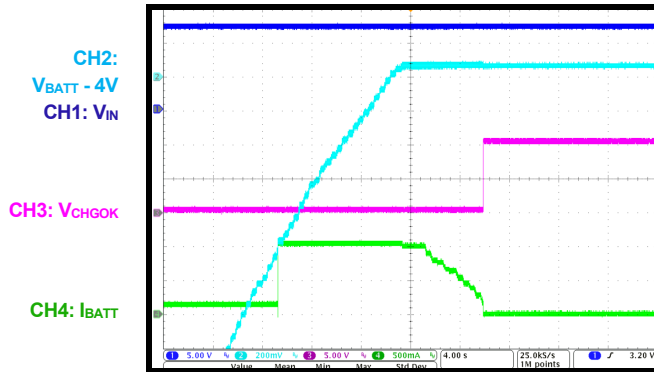

Automatic Recharge

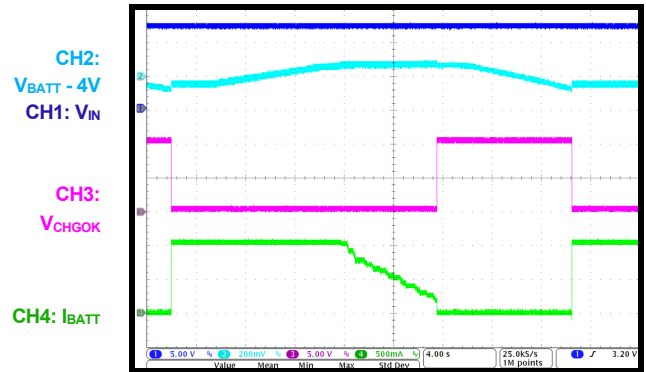

Trickle Charge to No Charge

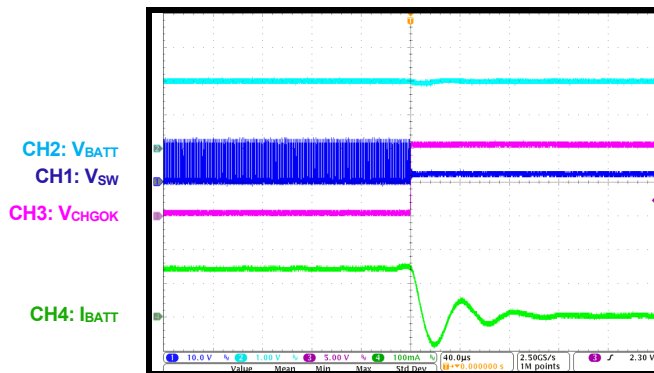

Trickle Charge

$V_{BATT} = 2.5V$

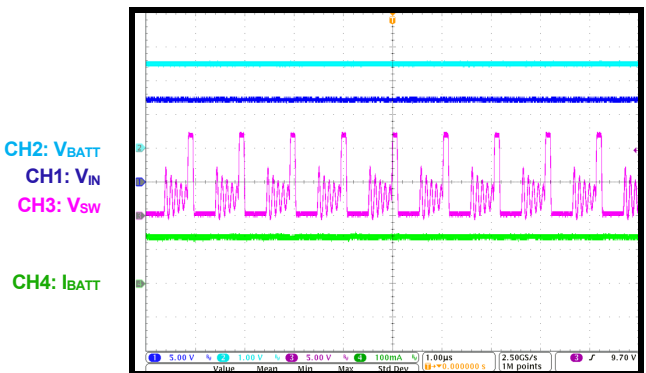

Constant Current Charge

$V_{BATT} = 3.7V$

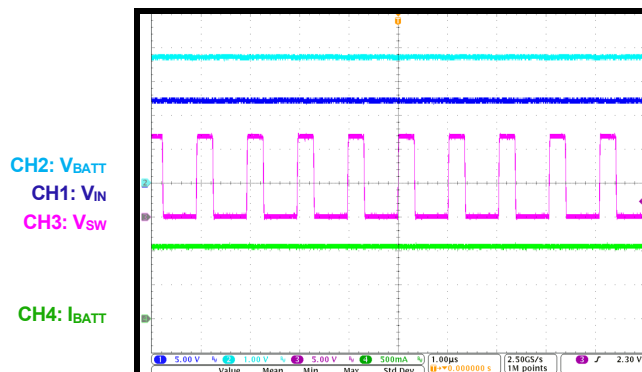

Constant Voltage Charge

$V_{BATT} = 4.05V$

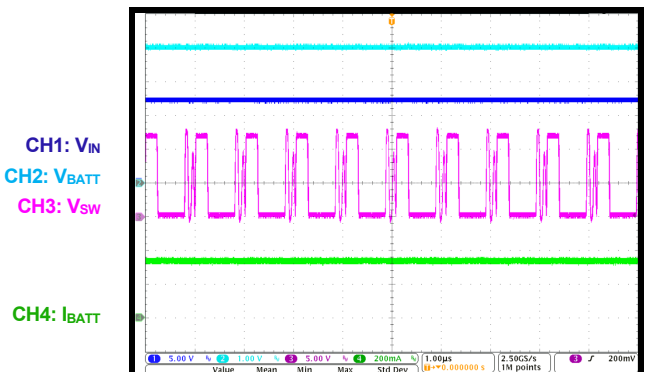

EVB TEST RESULTS *(continued)*

Performance curves and waveforms are tested on the evaluation board. $V_{IN} = 12V$, $V_{BATT} = 3.8V$, $L = 2.2\mu H$, $R_S = 47m\Omega$, $T_A = 25^\circ C$, $SEL = GND$, unless otherwise noted.

VIN Hot Plug-In

$V_{BATT} = 3.7V$

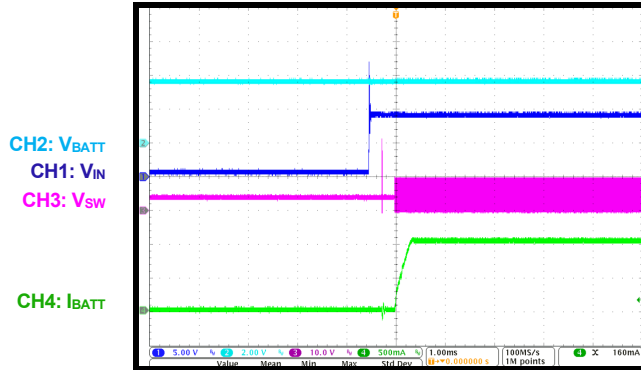

VIN Hot Plug-Out

$V_{BATT} = 3.7V$

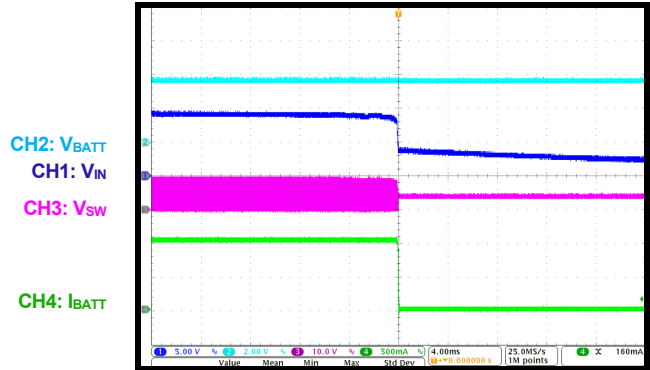

VIN Powers On Slowly

$V_{BATT} = 4.05V$

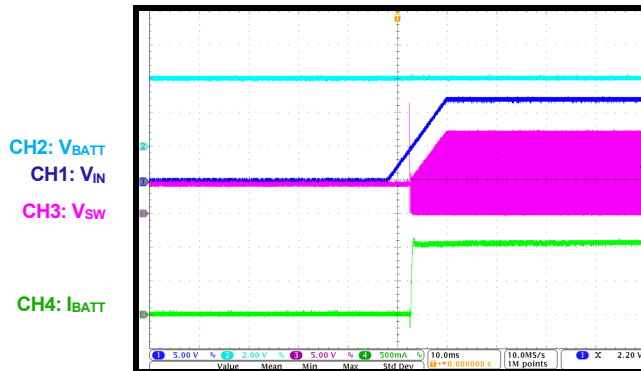

VIN Powers Off Slowly

$V_{BATT} = 4.05V$

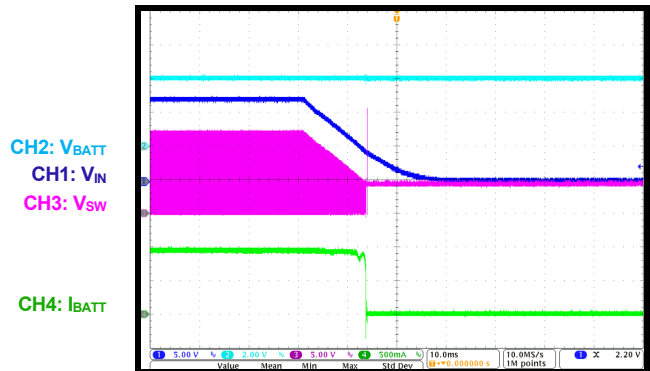

EN On

$V_{BATT} = 3.7V$

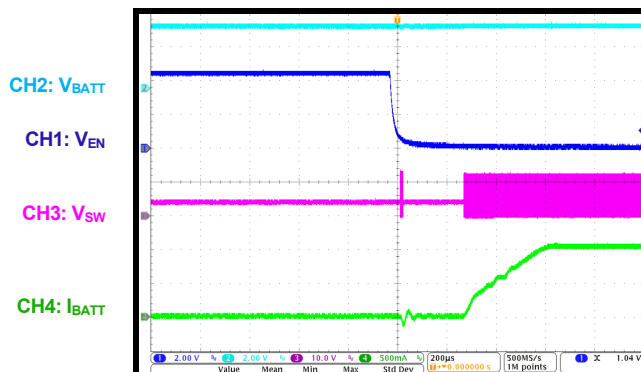

EN Off

$V_{BATT} = 3.7V$

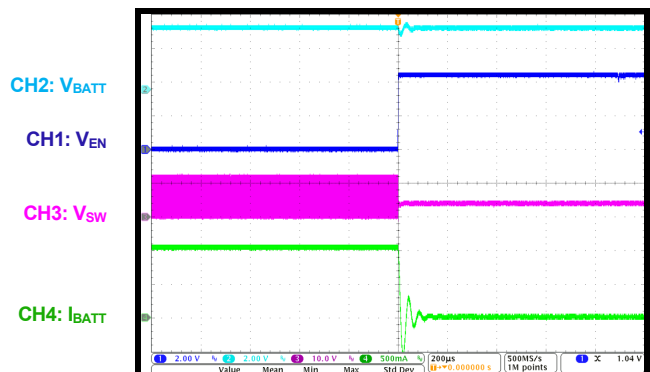

EVB TEST RESULTS (continued)

Performance curves and waveforms are tested on the evaluation board. V_{IN} = 12V, V_{BATT} = 3.8V, L = 2.2μH, R_S = 47mΩ, T_A = 25°C, SEL = GND, unless otherwise noted.

Battery Short Entry

V_{BATT} = 3.7V

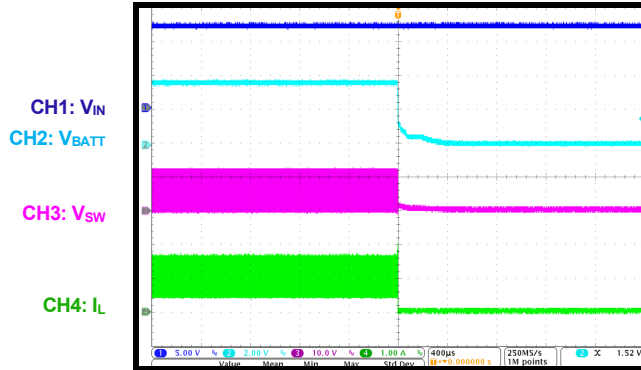

Battery Short Recovery

V_{BATT} = 3.7V

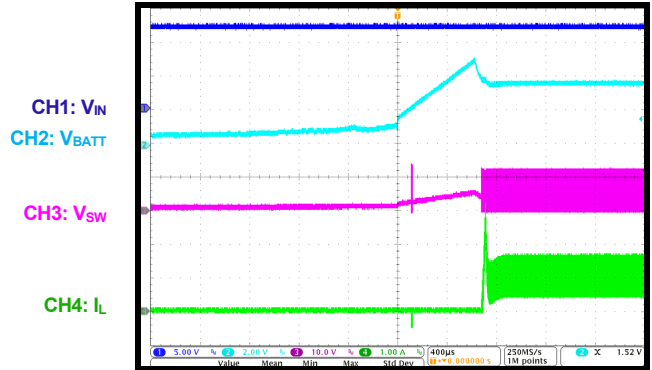

NTC Protection

V_{IN} = 5V, V_{BATT} = 4.05V

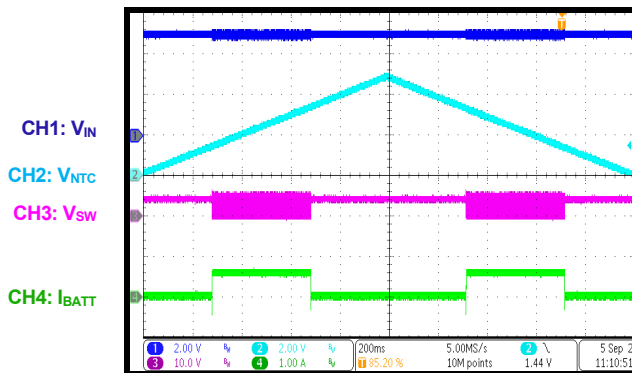

Timer Out

V_{IN} = 5V, V_{BATT} = 3.7V, C_{TMR} = 470pF

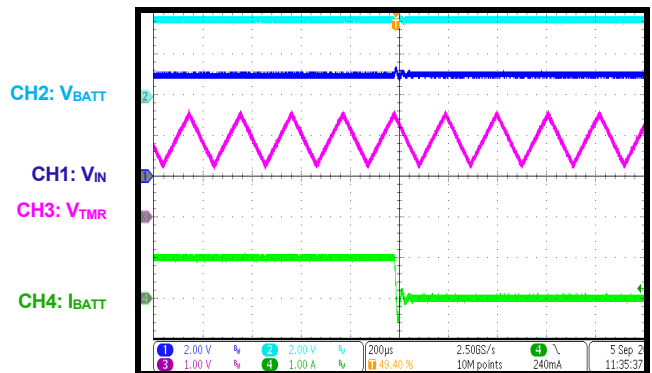

Charge Termination

V_{IN} = 5V, V_{BATT} = 4.05V

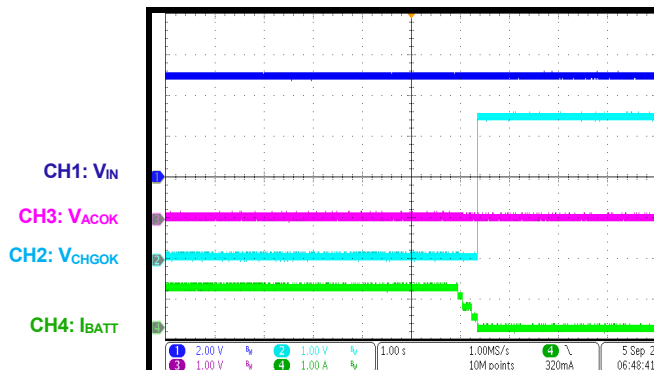

Thermal Shutdown and Recovery

V_{IN} = 5V, V_{BATT} = 3.7V

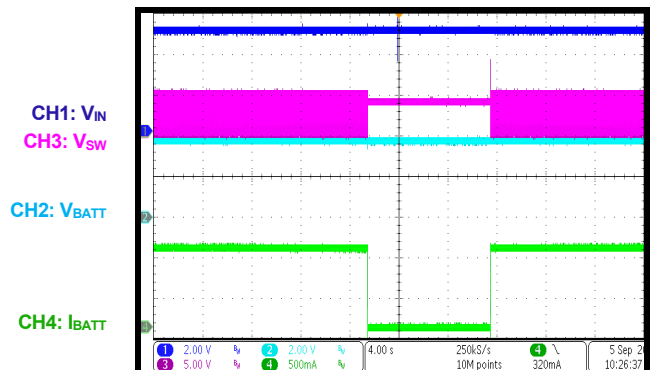

PCB LAYOUT

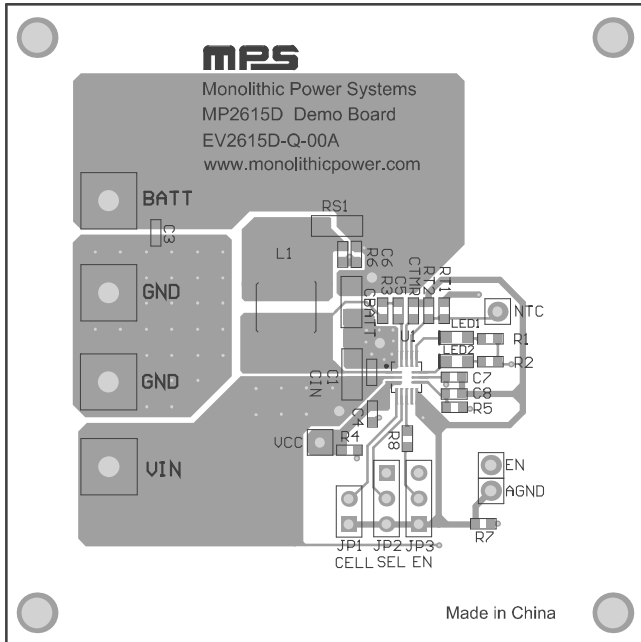

Figure 2: Top Layer

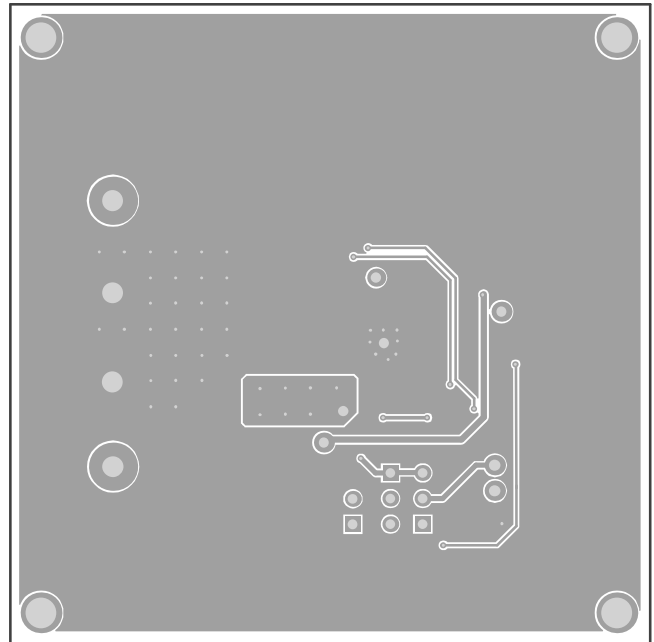

Figure 3: Bottom Layer



REVISION HISTORY

Revision #	Revision Date	Description	Pages Updated
1.0	3/13/2024	Initial Release	-

Notice: The information in this document is subject to change without notice. Please contact MPS for current specifications. Users should warrant and guarantee that third-party Intellectual Property rights are not infringed upon when integrating MPS products into any application. MPS will not assume any legal responsibility for any said applications.