



The Future of Analog IC Technology®

EV24833-N-00A

3A, 55V

White LED Driver

DESCRIPTION

The EV24833-N-00A Evaluation Board is designed to demonstrate the capabilities of MP24833GN. The MP24833 is a 55V, 3A, white LED driver suitable for step down, inverting step up/down and step up application.

EV24833-N-00A is compatible with step-down (Buck) and inverting step-up/down (Buck-boost) applications.

- For step-down application, short “JP1”, open “JP2”, connect LED load to “LED+” and “LED-”
- For step-up/down application, short “JP2”, open “JP1”, connect LED load to “LED+” and “LED-”

ELECTRICAL SPECIFICATION

	Parameter	Symbol	Value	Units
Buck-boost	Input Voltage	VIN	24	V
	LED Voltage	VLED	24	V
	LED Current	ILED	1	A
Buck	Input Voltage	VIN	28-50	V
	LED Voltage	VLED	24	V
	LED Current	ILED	1	A

FEATURES

- 3A Maximum Output Current
- Unique Step-Up/Down Operation (Buck-Boost Mode)
- Wide 4.5V-to-55V Operating Input Range for Step-Down Applications (Buck Mode)
- 0.19Ω Internal Power MOSFET Switch
- Fixed 200kHz Switching Frequency
- Analog and PWM Dimming
- 0.198V Reference Voltage
- 6μA Shutdown Mode
- No Minimum Number of LEDs Required
- Stable with Low ESR Output Ceramic Capacitors
- Cycle-by-Cycle Over-Current Protection
- Thermal Shutdown Protection
- Open Strings Protection
- Output Short-Circuit Protection
- Available in an SOIC8E Package

APPLICATIONS

- General LED Illumination
- LCD Backlight Panels
- Notebook Computers
- Automotive Internal Lighting
- Portable Device

EV24833-N-00A EVALUATION BOARD



(L x W x H) 5cm x 4.6cm x 1cm

Board Number	MPS IC Number
EV24833-N-00A	MP24833GN

Efficiency vs. LED Voltage

V_{IN}=24V, Buck-boost Application

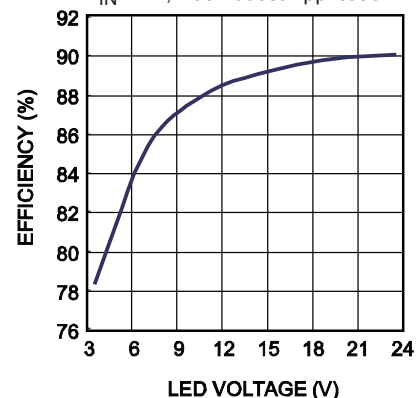

EVALUATION BOARD SCHEMATIC

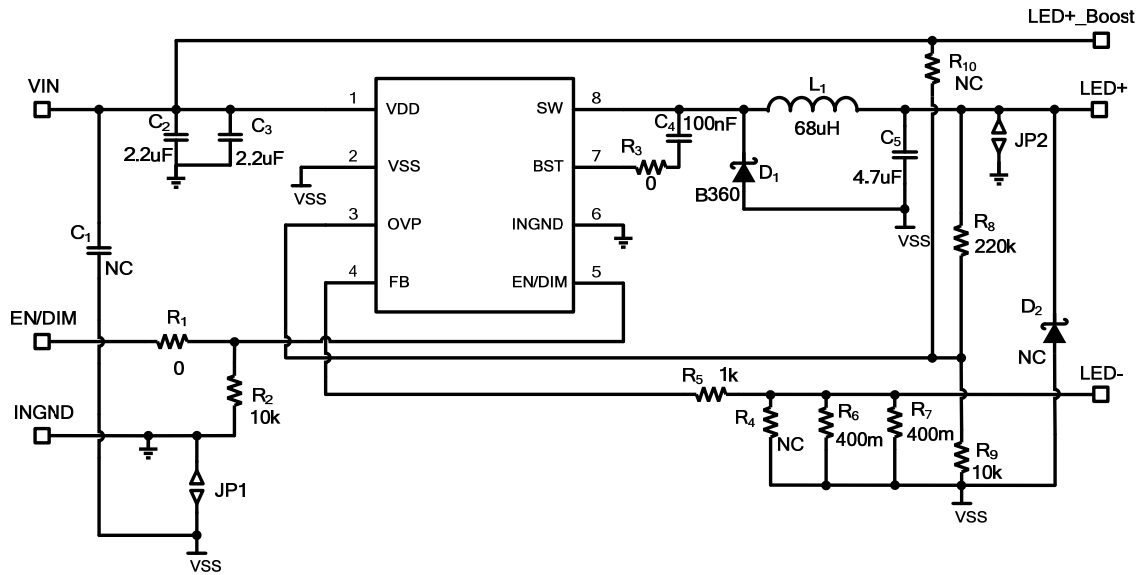

EV24833-N-00A BILL OF MATERIALS

Qty	Ref	Value	Description	Package	Manufacture	Manufacture_PN
1	C1	NC		1210		
2	C2, C3	2.2µF	Ceramic Capictor,50V, X7R, 1210	1210	TDK	C3225X7R1H225K
1	C4	100n	Ceramic Capictor,50V, X7R, 0603	0603	muRata	GRM188R71H104KA93D
1	C5	4.7µF	Ceramic Capictor,50V, X7R, 1210	1210	muRata	CRM32ER71H475KA88L
1	D1	B360A	Schottky Doide, 60V, 3A, SMA	SMA	Diode	B360A
1	D2	NC		SMA		
1	L1	68µH/3.2A	Inductor, 68µH, 88.5mΩ, 3.2A	SMD	WURTH	7447709680
2	R1, R3	0	Film Resistor;5%	0603	Yageo	RC0603JR-070RL
2	R2, R9	10k	Film Resistor;1%	0603	Yageo	RC0603FR-0710KL
1	R4	NC		0805		
1	R5	1k	Film Resistor;1%	0603	Ralec	RF0603-1K
2	R6, R7	400m	Film Resistor;1%	0805	ROYALOHM	0805F400LT5E
1	R8	226k	Film Resistor;1%	0603	Yageo	RC0603FR-07226KL
1	R10	NC		0603		
1	U1	MP24833	MP24833	SOIC8E	MPS	MP24833

EVB TEST RESULTS

Performance waveforms are tested on the evaluation board.

VIN = 36V, ILED = 1A, 7 LEDs in series, TA = 25°C, Buck Application, unless otherwise noted.

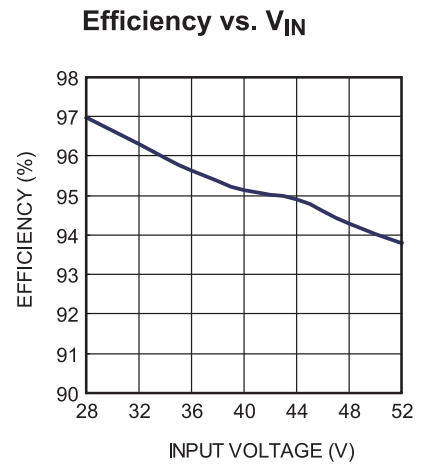
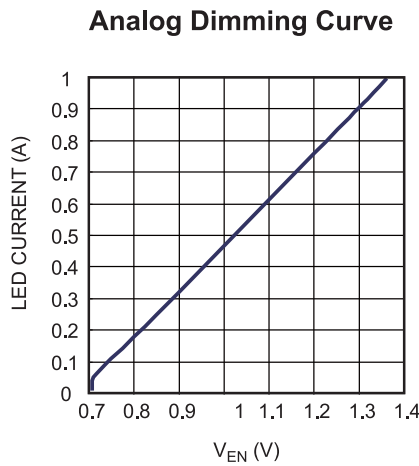
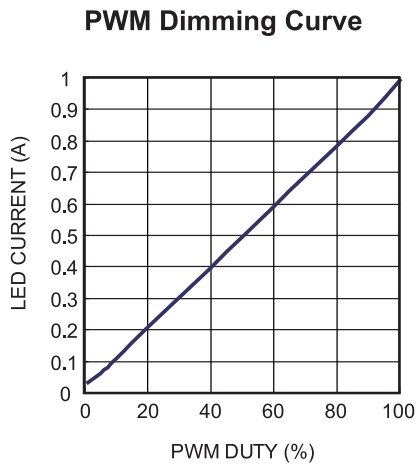
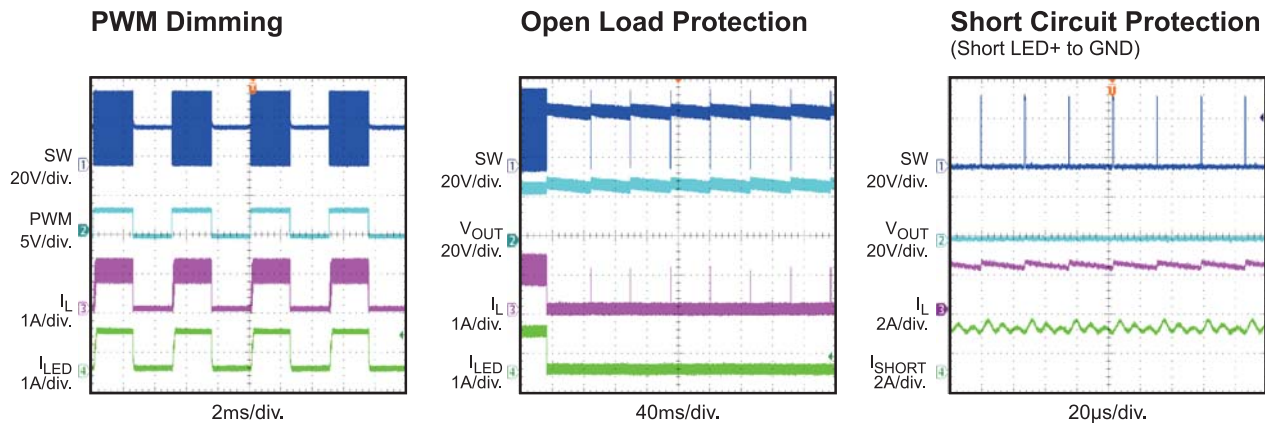
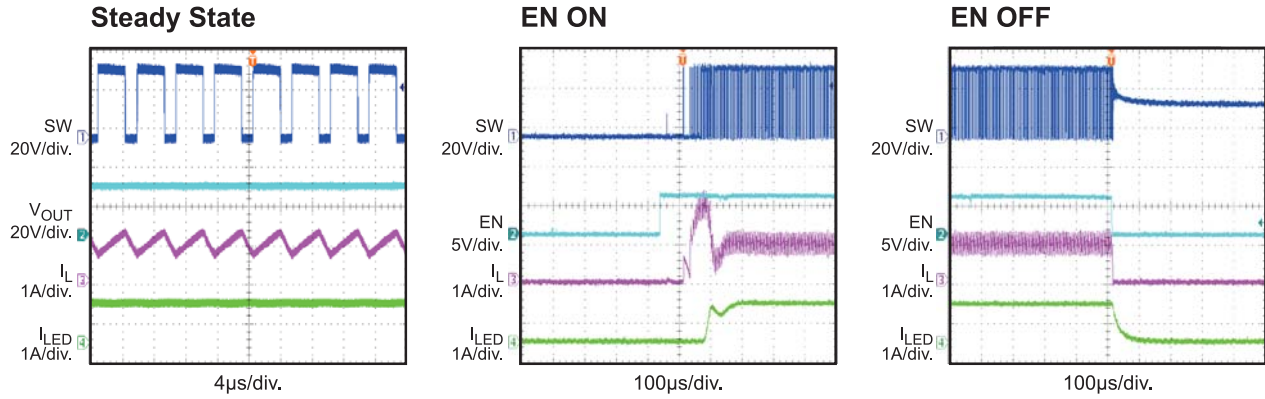

EVB TEST RESULTS (continued)

$V_{IN} = 24V$, $I_{LED} = 1A$, 7WLEDs in series, $T_A = 25^{\circ}C$, Buck-boost Application, Refer to INGND, unless otherwise noted.

Steady State

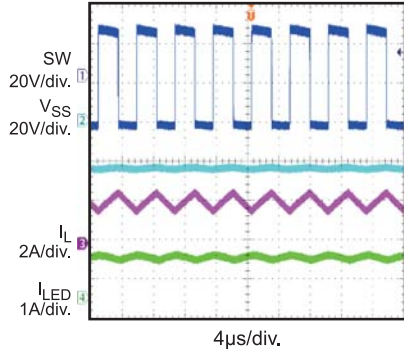

EN ON

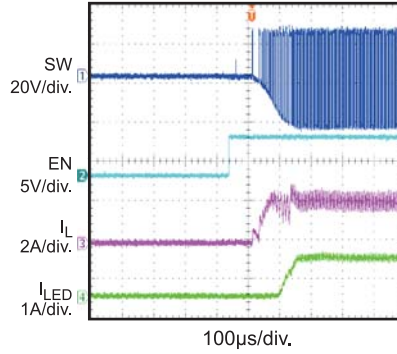

EN OFF

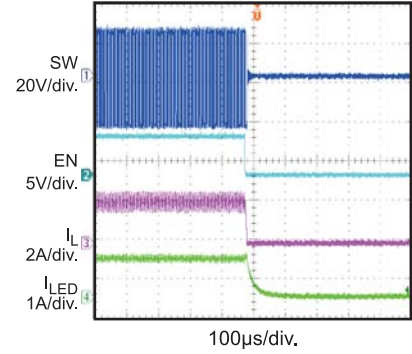

PWM Dimming

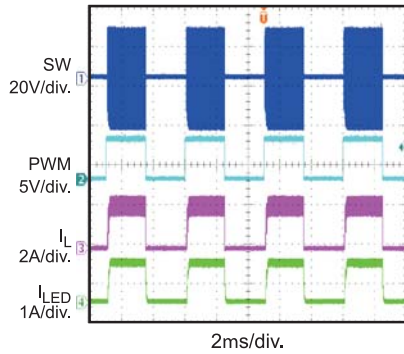

Open Load Protection

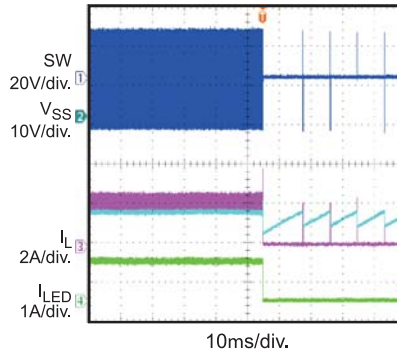

Short Circuit Protection
Short LED+ to VSS

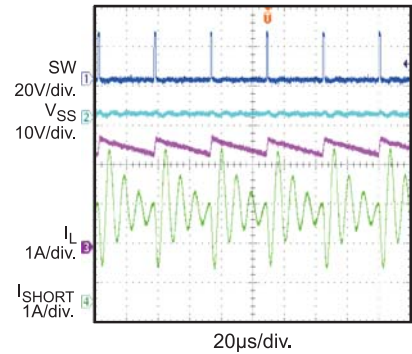

PWM Dimming Curve

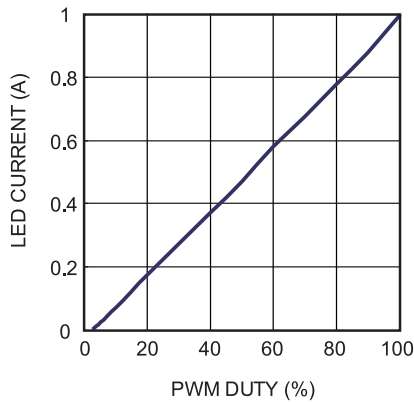

Analog Dimming Curve

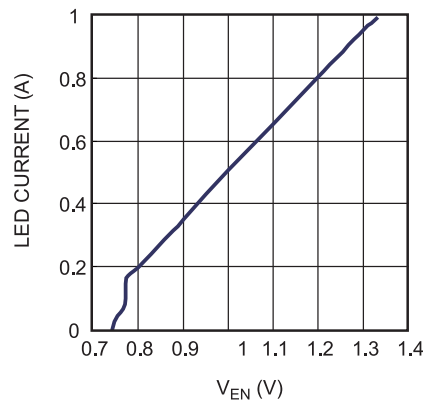

Efficiency vs. LED Voltage

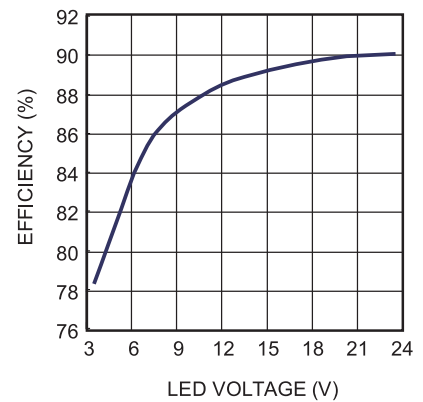

PRINTED CIRCUIT BOARD LAYOUT

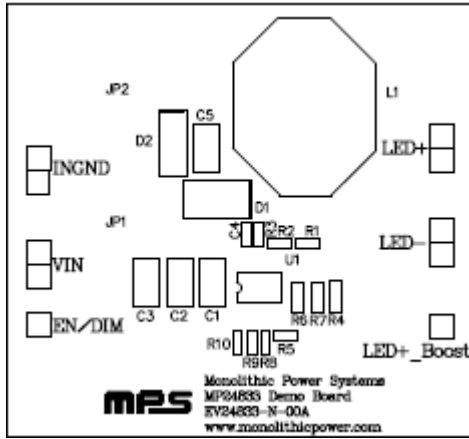

Figure 1—Top Silk Layer

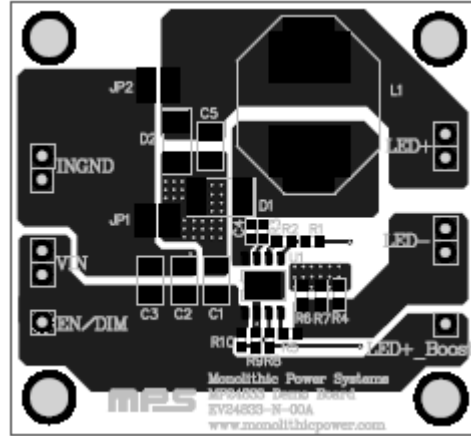

Figure 2—Top Layer

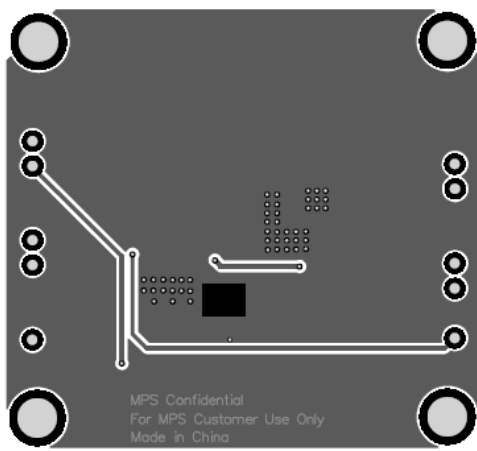

Figure 3—Bottom Layer

QUICK START GUIDE

1. Confirm the jumpers are connected correctly. For Buck applications short “JP1”, open “JP2”; and for Buck-boost applications, short “JP2”, and open “JP1”.
2. Check the LED string voltage and preset the input voltage power supply.
3. Set a second power supply to 2- 5V as the power supply for “EN/DIM”.
4. Turn-off all power supplies. Connect all the power supply.
5. Connect the anode of the LED string to LED+, and the cathode to LED-.
6. Turn on the power supplies. The LED string should be lighten
7. To demo analog dimming function, adjust the second power supply which connects to “EN/DIM” connector from 0.67V to 1.36V, the amplitude of LED current is from 0% to 100% of maximum LED current.
8. To demo the PWM dimming function: apply a 100Hz-to-2kHz square wave signal with amplitude greater than 1.5V to ”EN/DIM”
9. For combined analog and PWM dimming, apply a 100HZ to 2kHz square wave signal with amplitude from 0.67V to 1.36V.
10. To demo LED+ short to VSS protection in Buck-boost applications, please solder “D2” with a schottky diode as B160.
11. The EVB is also compatible with step-up application. For step-up application, short “JP2”, open “JP1”, connect LED load to “LED+ _Boost” and “LED-”.

NOTICE: The information in this document is subject to change without notice. Please contact MPS for current specifications. Users should warrant and guarantee that third party Intellectual Property rights are not infringed upon when integrating MPS products into any application. MPS will not assume any legal responsibility for any said applications.