

DESCRIPTION

The EV2459-J-00A is an evaluation board for the MP2459, a fixed 480kHz frequency step-down switching regulator with an integrated high-side high voltage power MOSFET.

The board can provide the load current up to 0.6A. High power conversion efficiency over a wide load range is achieved by scaling down the switching frequency at light load condition. The 5V to 55V input range accommodates a variety of step-down applications.

The board provides compact arrangement of components. By switching at 480kHz, smaller value inductor and input/output capacitor can be used to lower down cost and save board space.

ELECTRICAL SPECIFICATIONS

Parameter	Symbol	Value	Units
Input Voltage	V_{IN}	7-50	V
Output Voltage	V_{OUT}	5	V
Output Current	I_{OUT}	0-0.5	A

FEATURES

- Compact Arrangement of Components
- Wide Operating Input Range
- 0.5A Output Current
- Up to 90% Efficiency

APPLICATIONS

- Smart Power Meter
- High Voltage Power Conversion
- Automotive Systems
- Industrial Power Systems
- Distributed Power Systems
- Battery Powered Systems

All MPS parts are lead-free, halogen free, and adhere to the RoHS directive. For MPS green status, please visit MPS website under Quality Assurance.
 "MPS" and "The Future of Analog IC Technology" are Registered Trademarks of Monolithic Power Systems, Inc.

EV2459-J-00A EVALUATION BOARD



(L x W x H) 1.8" x 1.8" x 0.039"
 4.6cm x 4.8cm x 0.1cm

Board Number	MPS IC Number
EV2459-J-00A	MP2459-J

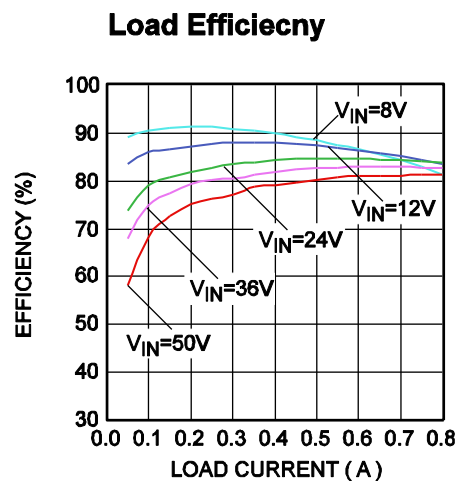

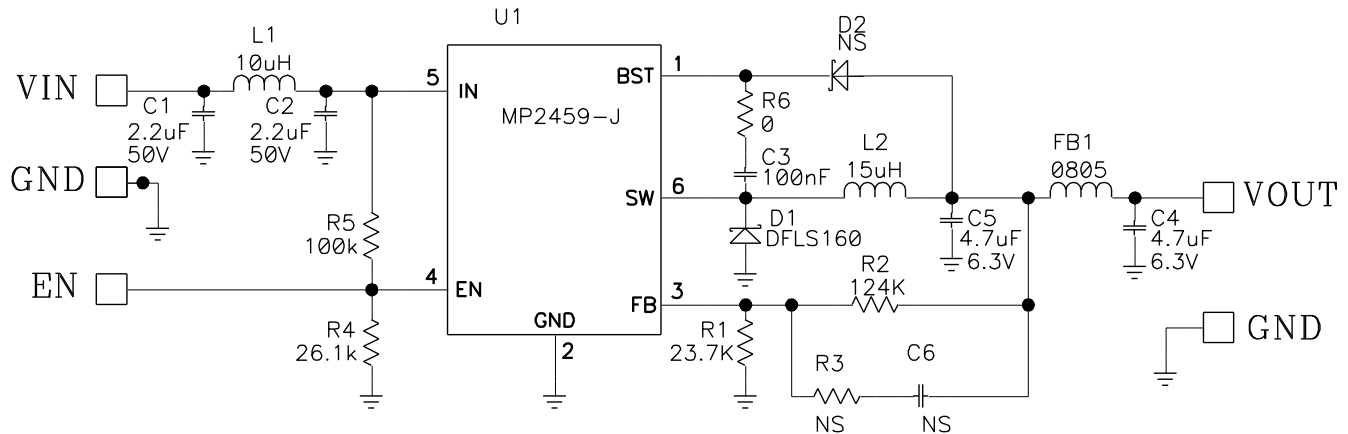
EVALUATION BOARD SCHEMATIC

EV2459-J-00A BILL OF MATERIALS

Qty	Reference	Value	Description	Package	Manufacturer	Manufacturer P/N
2	C1, C2	2.2 μ F	Ceramic Cap., 50V, 10%, X7R	1206	muRata	GRM31CR71H225KA88L
1	C3	0.1 μ F	Ceramic Cap., 50V, 10%, X7R	0603	muRata	GCJ188R71H104KA12D
2	C4, C5	4.7 μ F	Ceramic Cap., 6.3V, 10%, X5R	0603	muRata	GRM188R60J475KE19D
1	C6	NS	Ceramic Cap., 25V, 10%, X7R	0603	muRata	
1	D1	DFLS160	Schottky Rect., 60V, 1A	SMA	Diodes Inc	DFLS160
1	D2,	NS				
1	L2	15 μ H	Inductor, I _{dc} =0.7A	SMD 4x4mm	TDK	VLCF4020T-150MR68
1	L1	10 μ H	Inductor, I _{dc} =0.7A	SMD 4x4mm	TDK	VLCF4020T-100MR85
1	FB1		Magnetic Bead; 3A	0805	Wurth	74279206
1	R1	23.7k Ω	Film Res., 1%	0603	Yageo	RC0603FR-0723K7KL
1	R2	124k Ω	Film Res., 1%	0603	Yageo	RC0603FR-07124KL
1	R3	NS	Film Res., 5%	0603	Yageo	RC0603JR-070RL
1	R6	0	Film Res., 5%	0603	Yageo	RC0603JR-070RL
1	R4	26.1k Ω	Film Res., 1%	0603	Yageo	RC0603FR-0726K1KL
1	R5	100k Ω	Film Res., 1%	0603	Yageo	RC0603FR-07100KL
1	U1	MP2459	Buck DC-DC	TSOP6	MPS	MP2459_R0
4	VIN, GND, V OUT, GND		Power Test Point	2.3mm	HZ	China market
1	EN, GND		3x2.54mm Test Point	3x2.54mm	Sullins	PCC03SAAN

EVB TEST RESULTS

Performance waveforms are tested on the evaluation board.

$V_{IN}=12V$, $V_{OUT}=5V$, $L2=15\mu H$, $I_{OUT}=0.5A$, $T_A=25^\circ C$, unless otherwise noted.

Load Efficiency

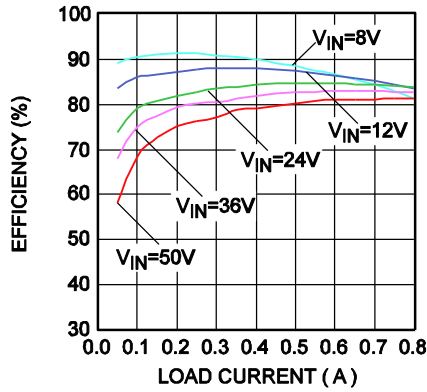

Line Efficiency

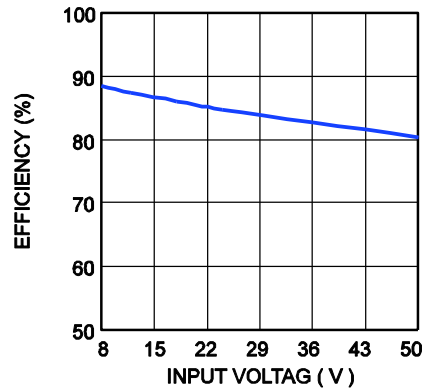

Load Regulation

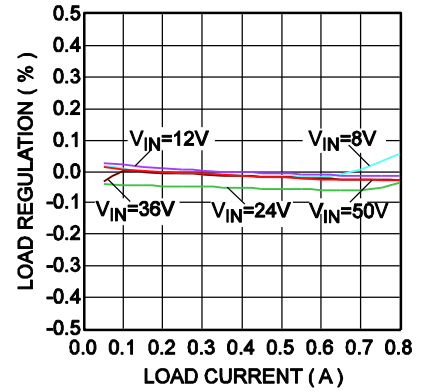

Line Regulation

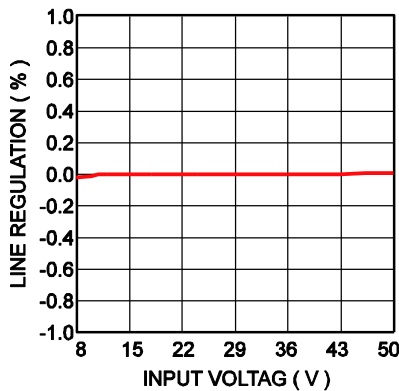

Bandwidth

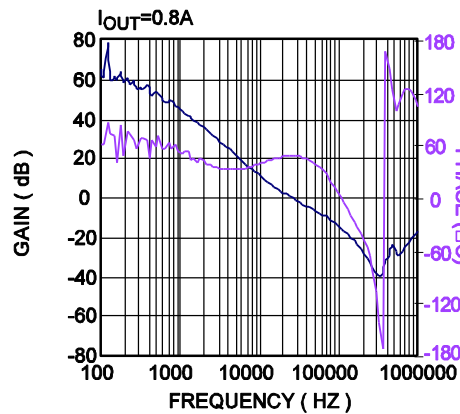

Operation Current

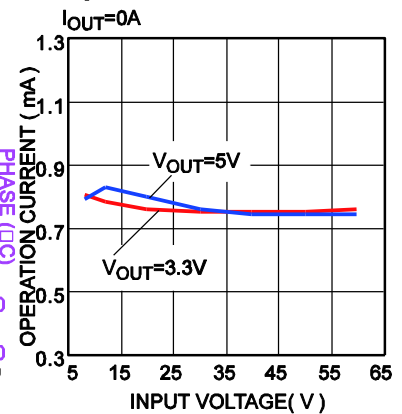

Current Limit vs. T_J

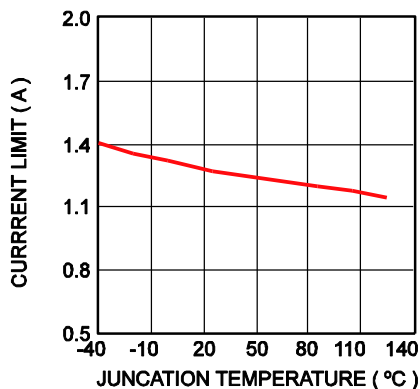

Frequency vs. T_J

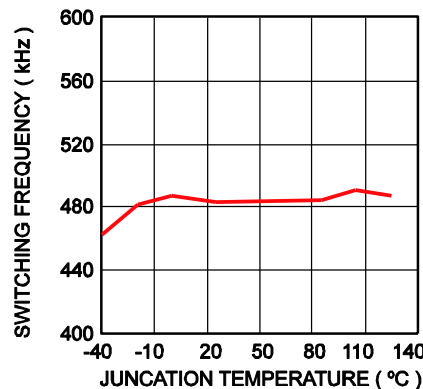

Feedback Voltage vs. T_J

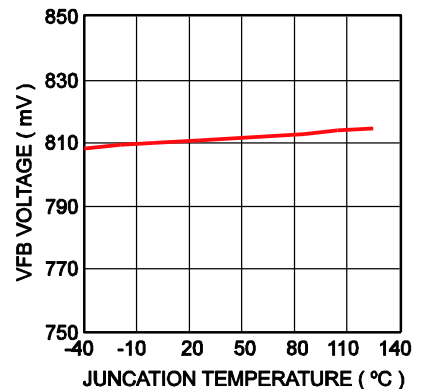

EVB TEST RESULTS (continued)

Performance waveforms are tested on the evaluation board.

$V_{IN}=12V$, $V_{OUT}=5V$, $L_2=15\mu H$, $I_{OUT}=0.5A$, $T_A=25^\circ C$, unless otherwise noted.

Steady State
 $V_{IN}=24V$

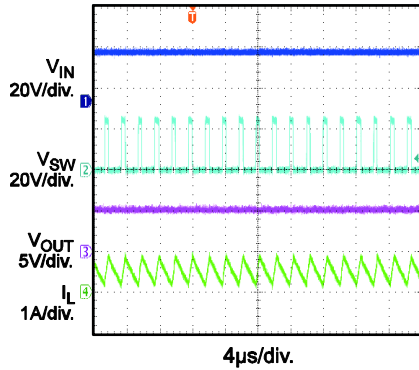

Steady State

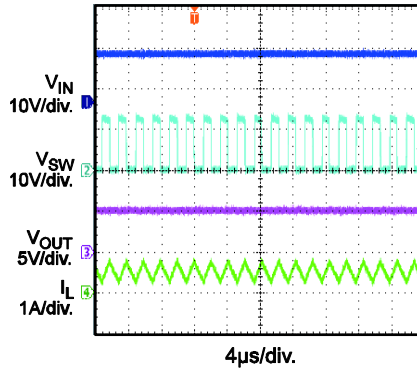

Load Transient
 $I_{OUT}=0.2A$ To $0.7A$

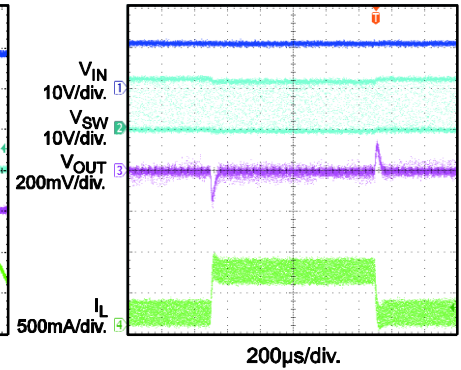

Power Ramp Up
 $V_{IN}=50V$

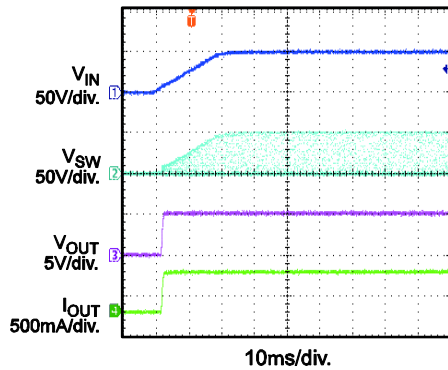

Power Ramp Down
 $V_{IN}=50V$

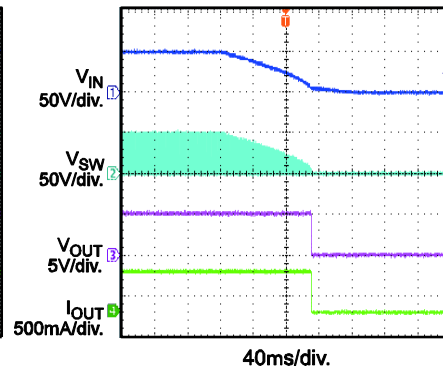

Short Output
 $I_{OUT}=0.65A$

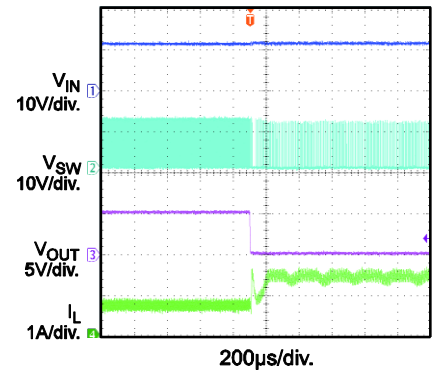

Enable On

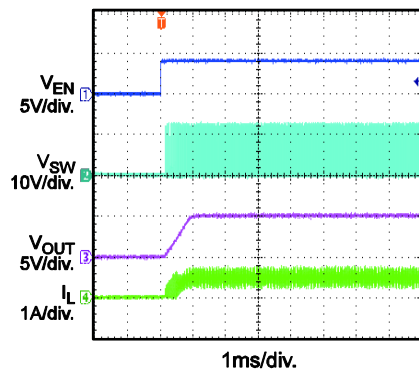

Enable Off

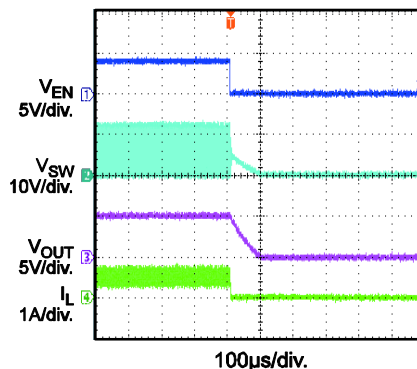

Short Output Recovery
 $I_{OUT}=0.65A$

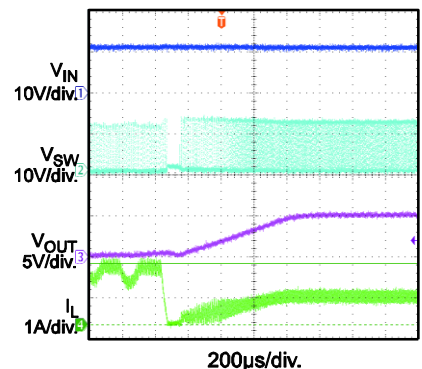

EVB TEST RESULTS (continued)

Performance waveforms are tested on the evaluation board.

$V_{IN}=12V$, $V_{OUT}=5V$, $L_2=15\mu H$, $I_{OUT}=0.5A$, $T_A=25^\circ C$, unless otherwise noted.

Conduction EMI

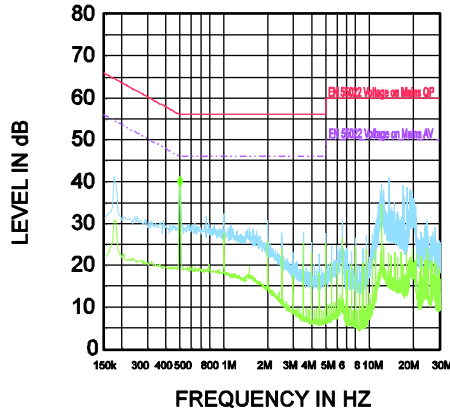

Radiation EMI

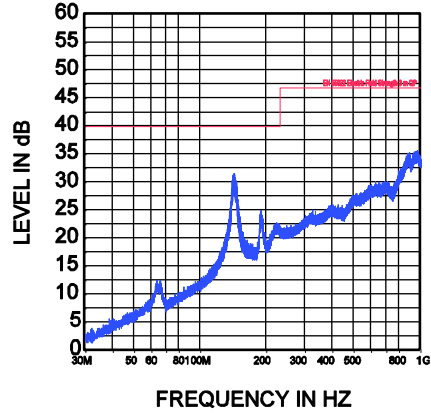

PRINTED CIRCUIT BOARD LAYOUT

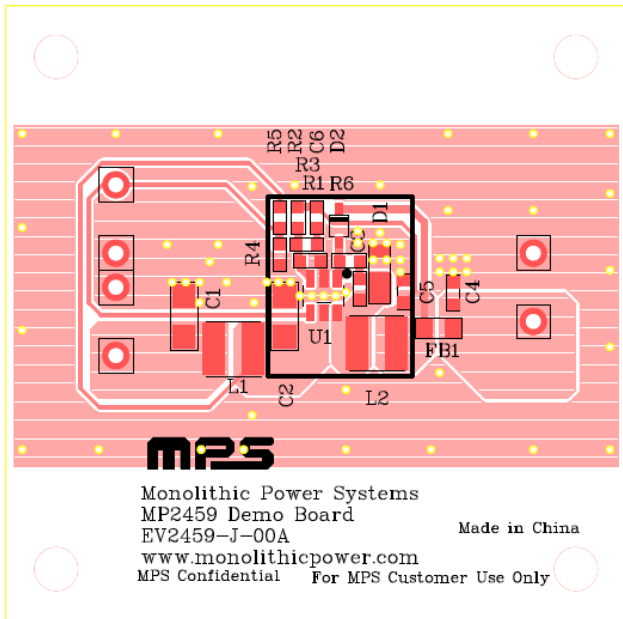

Figure 1—Top Silk Layer

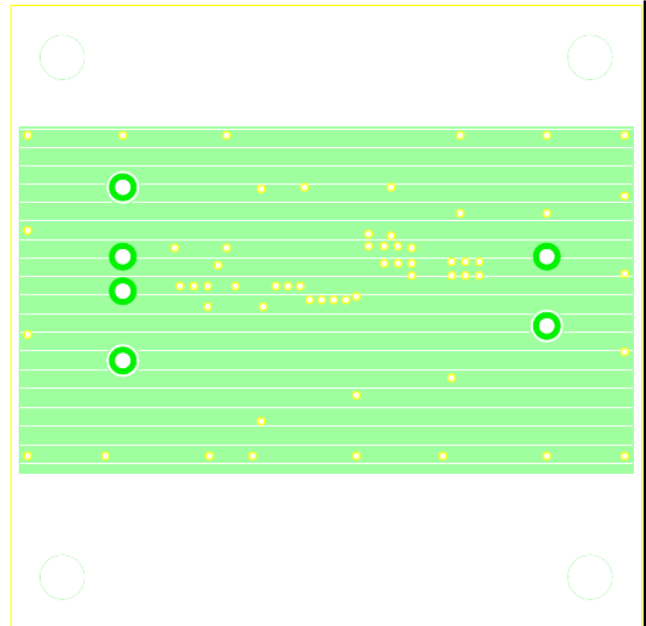

Figure 2—Bottom Layer

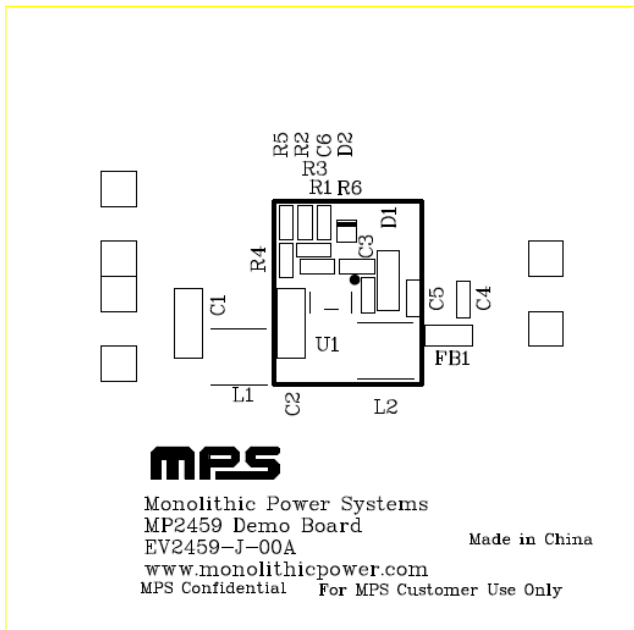

Figure 3—Top Silk

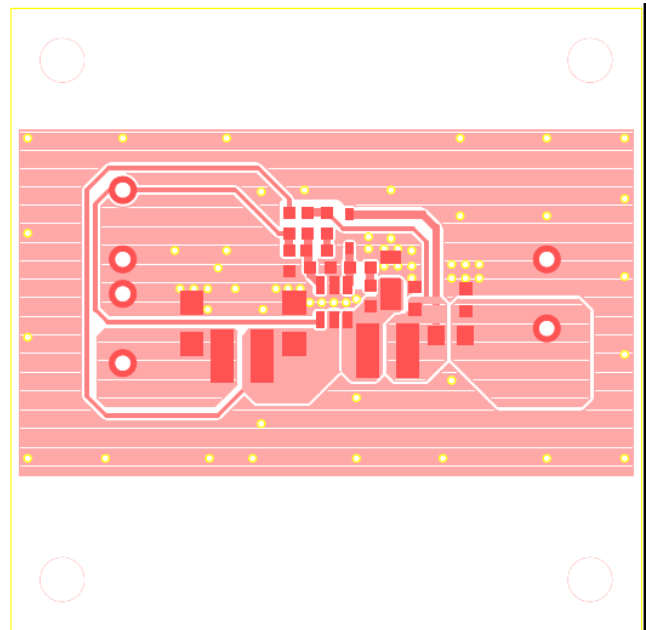

Figure 4- Top Layer

QUICK START GUIDE

1. Connect the positive terminal of the load to VOUT pin, and the negative terminal of the load to GND pins.
2. Preset the power supply output to 7-50V and turn off the power supply.
3. Connect the positive terminal of the power supply output to the VIN pin and the negative terminal of the power supply output to the GND pin.
4. Turn on the power supply. The board will automatically start up.
5. To adjust the output voltage, change the values of R1 and R2. Generally, Choose R2 around 124kΩ for optimal transient response. For $V_{FB}=0.812V$, $R_2=124k\Omega$, R1 can be determined by:

$$R1 = \frac{R2}{\frac{V_{OUT}}{0.812V} - 1}$$

Please follow the application information on the MP2459 datasheet to recalculate/select compensation values, the inductor value and the output capacitor value if the output voltage needs to be reprogrammed.

NOTICE: The information in this document is subject to change without notice. Users should warrant and guarantee that third party Intellectual Property rights are not infringed upon when integrating MPS products into any application. MPS will not assume any legal responsibility for any said applications.