



The Future of Analog IC Technology®

EV2377DN-00B

3A, 21V, 600KHz Step-Down Converter Evaluation Board

DESCRIPTION

The EV2377DN-00B is an evaluation board for the MP2377DN, a monolithic step-down switch mode converter with a built-in high-side power MOSFET.

The MP2377 achieves 3A continuous output current over a wide input supply range with excellent load and line regulation.

Current mode operation provides fast transient response and eases loop stabilization. Fault condition protection includes current limiting and thermal shutdown.

The MP2377 requires a minimum number of readily available standard external components. It is available in an 8-pin SOIC package with exposed pad.

ELECTRICAL SPECIFICATIONS

Parameter	Symbol	Value	Units
Input Voltage	V _{IN}	5 - 21	V
Output Voltage	V _{OUT}	3.3	V
Output Current	I _{OUT}	3	A

FEATURES

- 3A Output Current
- Wide 5V to 21V Operating Input Range
- 100mΩ Internal Power MOSFET Switch
- Power Good Indicator
- Stable with Low ESR Output Ceramic Capacitors
- Fixed 600kHz Frequency
- Synchronizable to >1MHz External Clock
- Over Current Latch Off Protection
- Output Adjustable from 0.8V to 15V
- Fully Assembled and Tested

APPLICATIONS

- Distributed Power Systems
- Battery Charger
- Pre-Regulator for Linear Regulators

"MPS" and "The Future of Analog IC Technology" are Registered Trademarks of Monolithic Power Systems, Inc.

EV2377DN-00B EVALUATION BOARD



(L x W x H) 2" x 2" x 0.5"
(5.1cm x 5.1cm x 1.2cm)

Board Number	MPS IC Number
EV2377DN-00B	MP2377DN

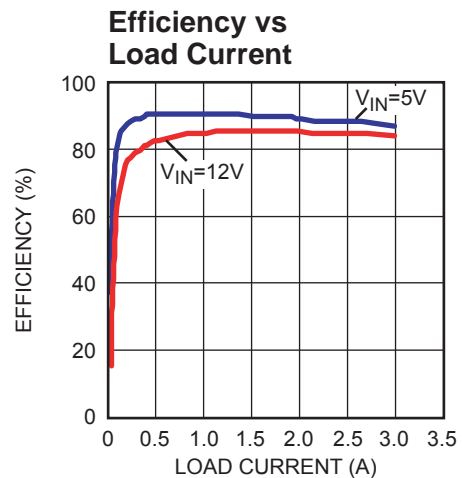

EVALUATION BOARD SCHEMATIC

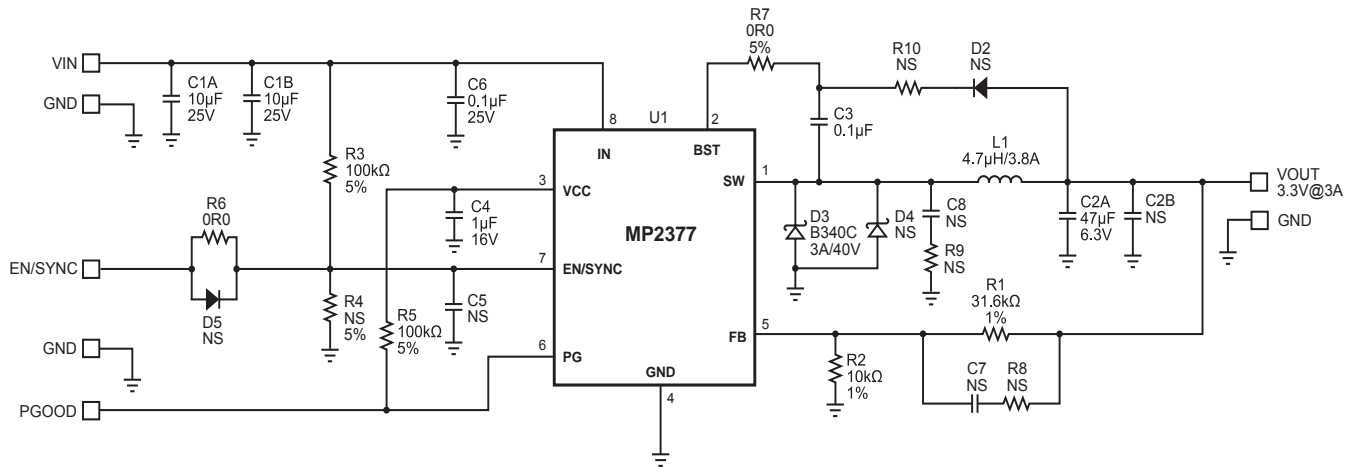

EV2377DN-00B BILL OF MATERIALS

Qty	Ref	Value	Description	Package	Manufacturer	Manufacturer P/N
2	C1A,C1B	10µF	Ceramic Cap. 25V, X7R	1210	TDK	C3225X7R1E106K
1	C2A	47µF	Ceramic Cap. 6.3V, X7R	1210	TDK	C3225X7R0J476K
2	C3,C6	0.1µF	Ceramic Cap. 25V, X7R	0603	TDK	C1608X7R1E104K
1	C4	1µF	Ceramic Cap. 16V, X7R	0603	TDK	C1608X7R1C105K
4	C2B,C5,C7,C8	NS	Not Stuffed			
3	D2,D4,D5	NS	Not Stuffed			
1	D3	B340	Schottky Diode, 40V, 3A	SMC	Diodes Inc.	B340-13-F
1	L1	4.7µH	Inductor, 4.7µH, 3.8A	DS84LC	TOKO	B1015AS-4R7N
1	R1	31.6kΩ	Film Resistor, 1%	0603	Panasonic	ERJ-3EKF3162V
1	R2	10.0kΩ	Film Resistor, 1%	0603	Panasonic	ERJ-3EKF1002V
2	R3,R5	100kΩ	Film Resistor, 5%	0603	Panasonic	ERJ-3GEYJ104V
4	R4,R8,R9,R10	NS	Not Stuffed			
2	R6,R7	0Ω	Film Resistor 5%	0603	Panasonic	ERJ-3GEY0R00V
1	U1	MP2377DN	Step-Down Converter	SOIC8	MPS	MP2377DN

PRINTED CIRCUIT BOARD LAYOUT

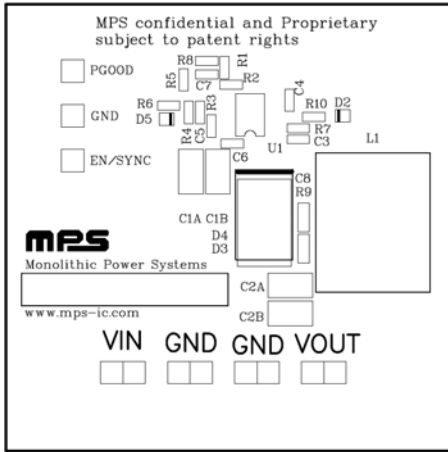

Figure 1—Top Silk Layer

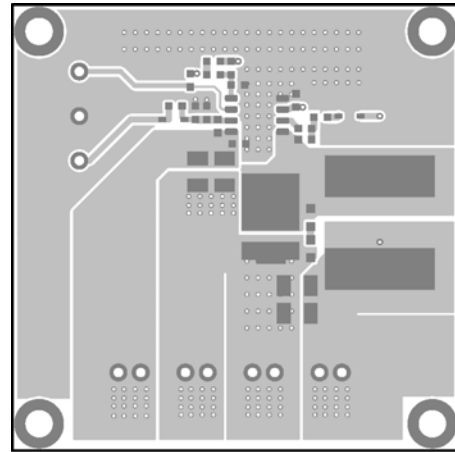

Figure 2—Top Layer

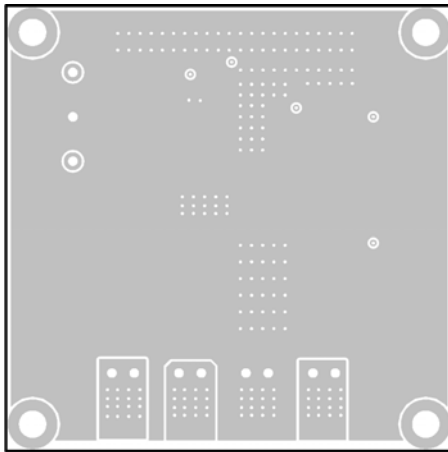

Figure 3—Inner Layer 1

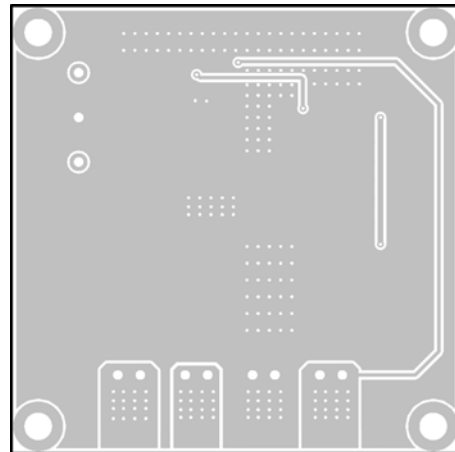

Figure 4—Inner Layer 2

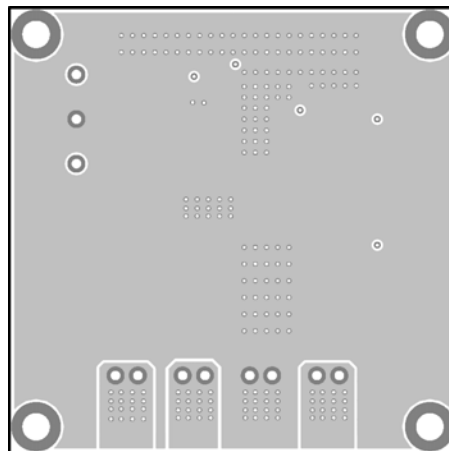

Figure 5—Bottom Layer

QUICK START GUIDE

1. Connect the positive and negative terminals of the load to V_{OUT} and GND pins, respectively.
2. Preset the power supply output to 5V – 21V and turn off the power supply.
3. Connect the positive and negative terminals of the power supply output to the VIN and GND pins, respectively.
4. Turn the power supply on. The board will automatically startup.
5. To use the Enable function, apply a digital input to EN pin. Drive EN higher than 1.2V to turn on the regulator, drive EN less than 0.4V to turn it off.
6. Apply up to 1.4MHz frequency logic level clock signal to the EN pin to synchronize the device to an external clock. The duty cycle is not critical.

NOTICE: The information in this document is subject to change without notice. Please contact MPS for current specifications. Users should warrant and guarantee that third party Intellectual Property rights are not infringed upon when integrating MPS products into any application. MPS will not assume any legal responsibility for any said applications.