



EV2331H-TL-00A

High-Efficiency, 1.2MHz, 2A, 24V. Step-Down Converter Evaluation Board

DESCRIPTION

The EV2331H-TL-00A Evaluation Board is designed to demonstrate the capabilities of MPS' MP2331H, a fully-integrated high-frequency, synchronous rectified, step-down, switch-mode converter with internal power MOSFETs. It offers a very compact solution to achieve a 2A continuous output current over a wide input range, with excellent load and line regulation. The MP2331H has synchronous-mode operation for higher efficiency over the output current-load range.

Constant On-Time control operation provides very fast transient response and easy loop design as well as very tight output regulation.

Full protection features include SCP, OCP, UVP, and thermal shutdown.

The MP2331H requires a minimal number of readily-available, standard, external components and is available in a space-saving SOT583 (1.6mmx2.1mm) package.

ELECTRICAL SPECIFICATION (1)

Parameter	Symbol	Value	Units
Input Voltage	V_{IN}	19	V
Output Voltage	V_{OUT}	3.3	V
Output Current	I_{OUT}	2	A

Notes:

1) For different Input/output voltage specs and different output capacitor/inductor may need change the application circuit parameters.

FEATURES

- Wide 4.2V-to-24V Operating Input Range
- 110mΩ/45mΩ Low- $R_{DS(ON)}$ Internal Power MOSFETs
- 200μA Low I_q
- High-Efficiency Synchronous-Mode Operation
- Fast Load Transient Response
- 1.2MHz Switching Frequency
- Ton Extension
- Forced PWM Operation
- Programmable Soft-Start Time
- Power Good Indication
- Over-Current Protection and Hiccup
- Pre-bias Startup
- Thermal Shutdown
- Available in a SOT583 package

APPLICATIONS

- Game Consoles
- Digital Set-Top Boxes
- Flat-Panel Television and Monitors
- General Purposes

All MPS parts are lead-free, halogen free, and adhere to the RoHS directive. For MPS green status, please visit MPS website under Quality Assurance.

"MPS" and "The Future of Analog IC Technology" are Registered Trademarks of Monolithic Power Systems, Inc.

EV2331H-TL-00A EVALUATION BOARD

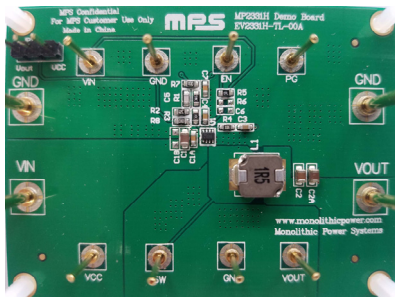

(L x W x H) 63.7mm x 48.4mm x 6.4mm

Board Number	MPS IC Number
EV2331H-TL-00A	MP2331HGTL

Efficiency

$V_{OUT}=3.3V$, $L=2.2\mu H$, $DCR=11.4m\Omega$

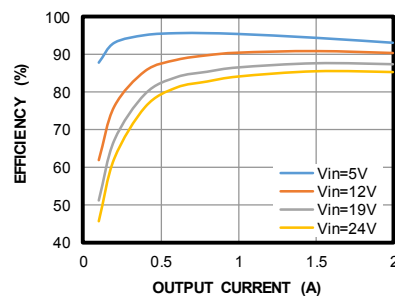

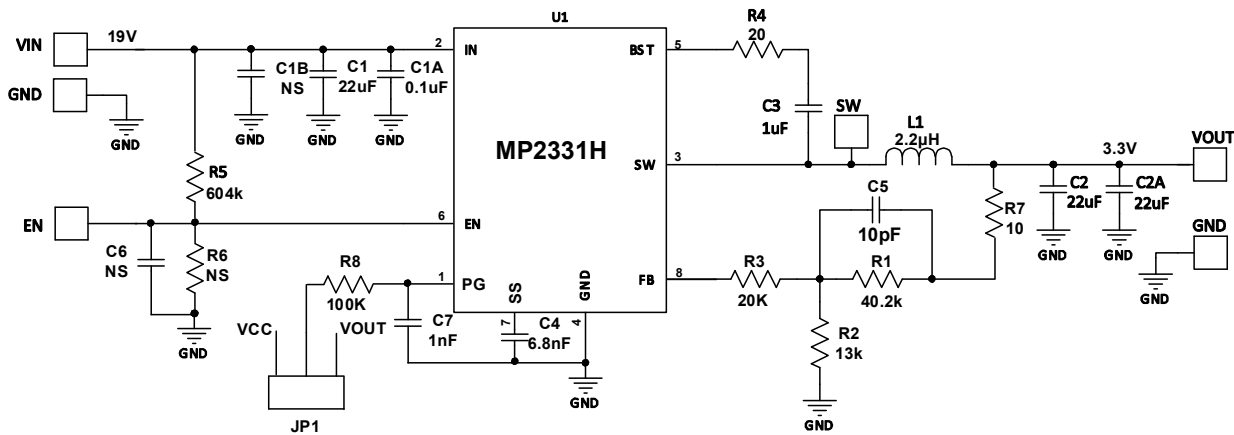
EVALUATION BOARD SCHEMATIC

EV2331H-TL-00A BILL OF MATERIALS

Qty	Ref	Value	Description	Package	Manufacturer	Part Number
1	C1	22μF	Ceramic Cap., 25V, X5R	0805	muRata	GRM21BR61E226ME44L
1	C1A	0.1μF	Ceramic Cap., 25V, X7R	0603	muRata	GRM188R71E104KA01D
2	C2,C2A	22μF	Ceramic Cap., 16V, X5R	0805	muRata	GRM21BR61C226ME44L
1	C3	1μF	Ceramic Cap., 16V, X7R	0603	muRata	GRM188R71C105KA12D
1	C4	6.8nF	Ceramic Cap., 50V, X7R	0603	muRata	GRM188R71H682KA01D
1	C5	10pF	Ceramic Cap., 50V, COG	0603	muRata	GRM1885C1H100JA01D
0	C1B,C6	NS				
1	C7	1nF	Ceramic Cap., 50V, X7R	0603	muRata	GRM188R71H102KA01D
1	R1	40.2k	Thick Film Res., 1%	0603	Yageo	RC0603FR-0740K2L
1	R2	13k	Thick Film Res., 1%	0603	Yageo	RC0603FR-0713KL
1	R3	20k	Thick Film Res., 1%	0603	Yageo	RC0603FR-0720KL
1	R4	20Ω	Thick Film Res., 1%	0603	Yageo	RC0603FR-0720RL
1	R5	604k	Thick Film Res., 1%	0603	Yageo	RC0603FR-07604KL
0	R6	NS				
1	R7	10Ω	Thick Film Res., 1%	0603	Yageo	RC0603JR-0710RL
1	R8	100k	Thick Film Res., 1%	0603	Yageo	RC0603FR-07100KL
1	L1	2.2μH	Inductor, DCR=15mΩ, Is=8.6A	SMD	Sunlord	WPL6530H2R2MT
1	U1	MP2331H GTL	Synchronous Step-Down Converter	SOT583	MPS	MP2331HGTL
1	JP1	Jumper	Jumper	SIP-3	Any	

EVB TEST RESULTS

$V_{IN} = 19V$, $V_{OUT} = 3.3V$, $L = 2.2\mu H$, $T_A = +25^\circ C$, unless otherwise noted.

Input/Output ripple

$I_{OUT} = 0A$

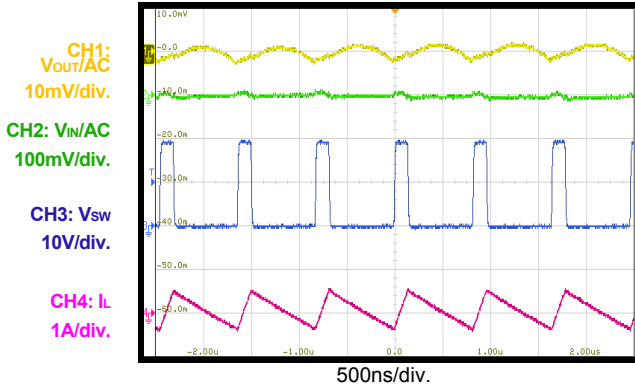

Input/Output ripple

$I_{OUT} = 2A$

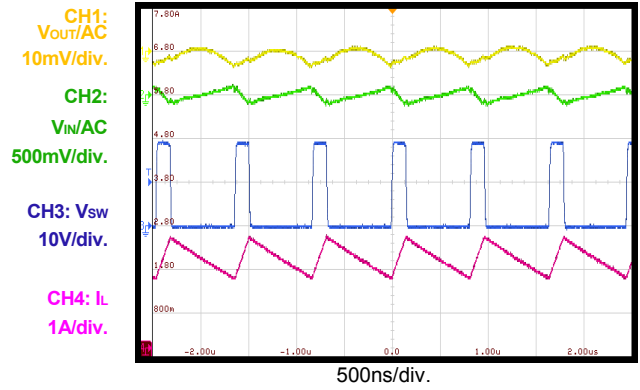

Startup through input voltage

$I_{OUT} = 0A$

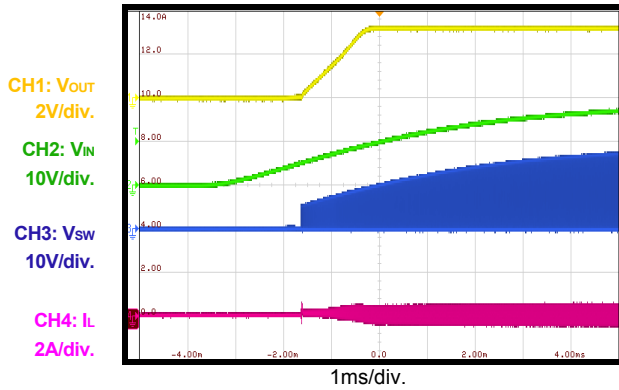

Startup through input voltage

$I_{OUT} = 2A$

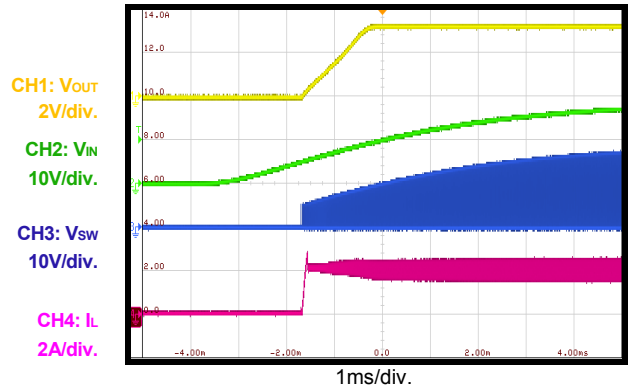

Shutdown through input voltage

$I_{OUT} = 0A$

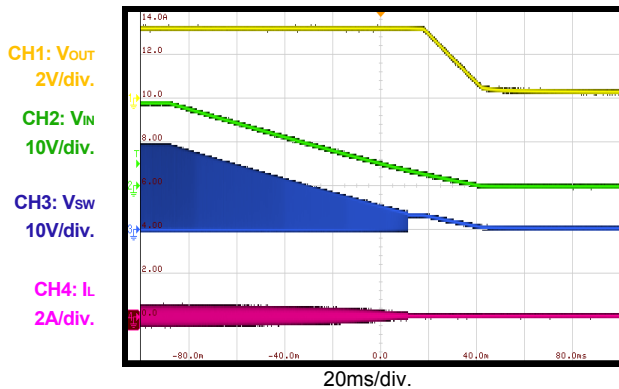

Shutdown through input voltage

$I_{OUT} = 2A$

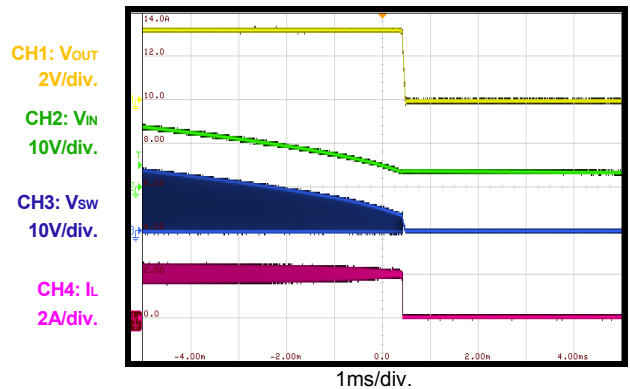

EVB TEST RESULTS (continued)

$V_{IN} = 19V$, $V_{OUT} = 3.3V$, $L = 2.2\mu H$, $T_A = +25^\circ C$, unless otherwise noted.

Startup through EN

$I_{OUT} = 0A$

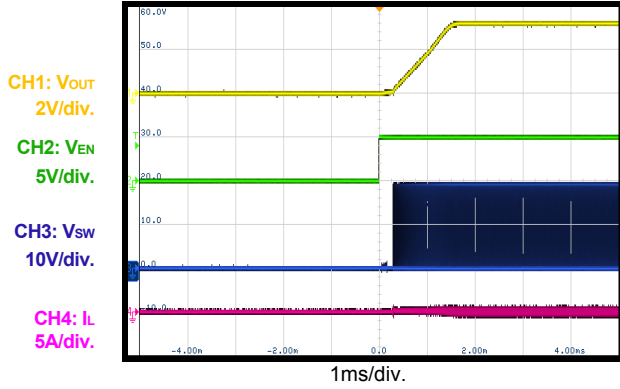

Startup through EN

$I_{OUT} = 2A$

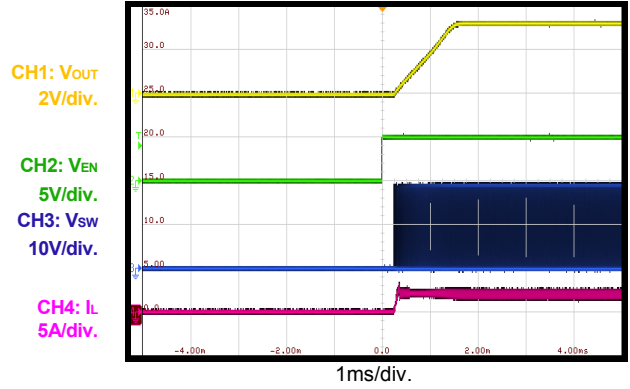

Shutdown through EN

$I_{OUT} = 0A$

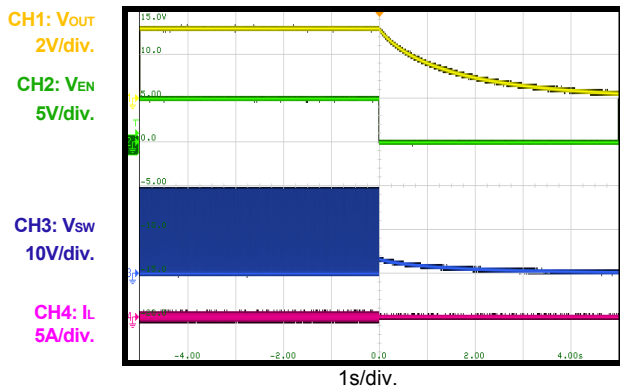

Shutdown through EN

$I_{OUT} = 2A$

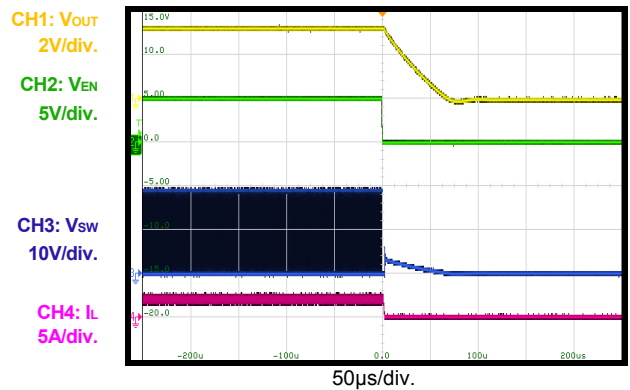

Short-Circuit entry

$I_{OUT} = 0A$

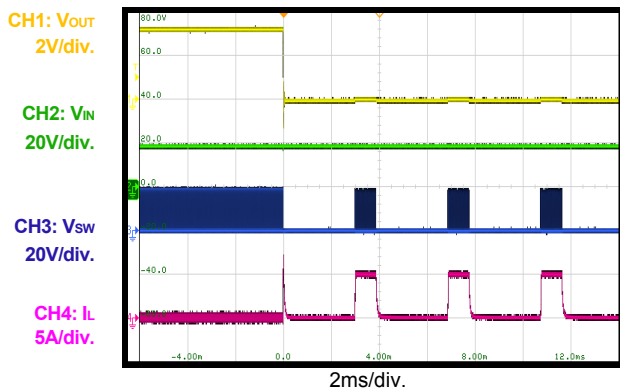

Short-Circuit recovery

$I_{OUT} = 0A$

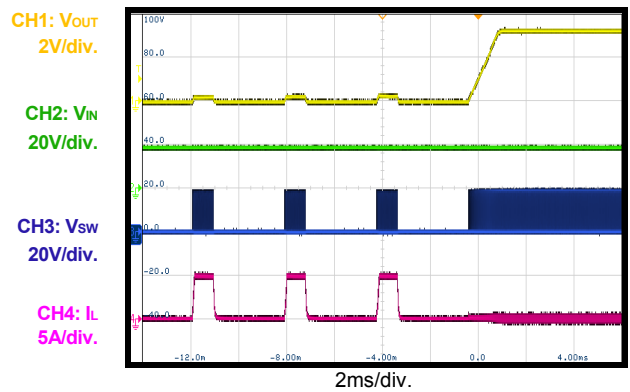

EVB TEST RESULTS *(continued)*

$V_{IN} = 19V$, $V_{OUT} = 3.3V$, $L = 2.2\mu H$, $T_A = +25^\circ C$, unless otherwise noted.

Load transient

$I_{OUT} = 1A$ to $2A$, Slew rate is $2.5A/\mu s$ by CCDH

E-load

CH1:
 V_{out}/AC
100mV/div.

CH4: I_{out}
1A/div.

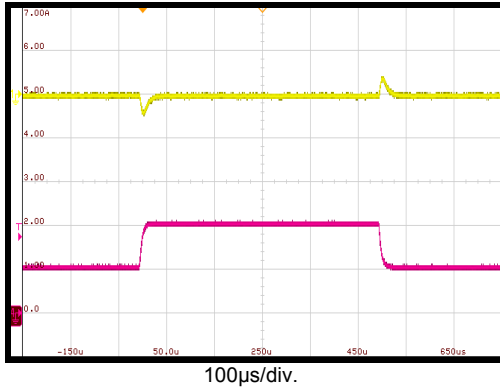

PRINTED CIRCUIT BOARD LAYOUT

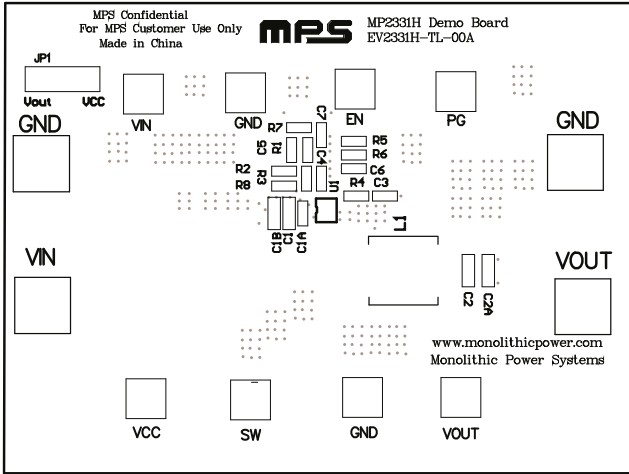

Figure 1: Top Silk Layer

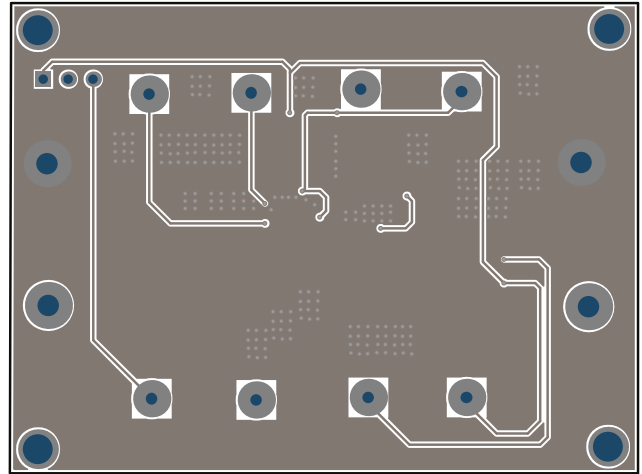

Figure 2: Top Layer

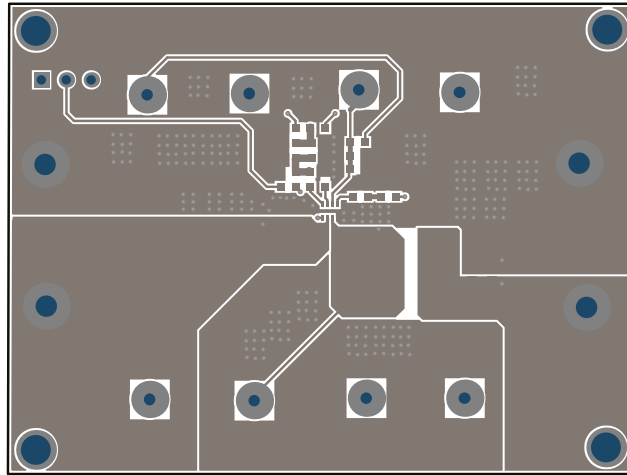

Figure 3: Bottom Layer

QUICK START GUIDE

1. Preset Power Supply to 19V.
2. Turn Power Supply off.
3. Connect Power Supply terminals to:
 - a. Positive (+): VIN
 - b. Negative (-): GND
4. Connect Load to:
 - a. Positive (+): VOUT
 - b. Negative (-): GND
5. Turn Power Supply on after making connections. The board will automatically start up.
6. To use the Enable function, apply a digital input to the EN pin. Drive EN higher than 1.3V to turn on the regulator, or less than 1V to turn it off.
7. To use PG indication function, connect PG to VOUT or an external VCC through a pull up resistor (R8). Recommend 3.3V pull up source.

NOTICE: The information in this document is subject to change without notice. Please contact MPS for current specifications. Users should warrant and guarantee that third party Intellectual Property rights are not infringed upon when integrating MPS products into any application. MPS will not assume any legal responsibility for any said applications.