

### DESCRIPTION

The EV2326-D-00A is used for demonstrating the performance of MP2326, a fully-integrated, high efficiency, synchronous step-down switch mode converter with the feathered 40uA quiescent current. MP2326 provides up to 4A continuous output current over a wide input supply range with constant-on-time control for fast loop response.

High power efficiency over a wide load range is achieved by scaling down the switching frequency at light load to reduce the switching related loss by constant on time control. Short circuit and thermal shutdown provides reliable, fault-tolerant operation.

MP2326 is available in 2mmx3mm 14-pin QFN package.

### ELECTRICAL SPECIFICATION<sup>(1)</sup>

Parameter	Symbol	Value	Units
Input Voltage	V <sub>IN</sub>	12	V
Output Voltage	V <sub>OUT</sub>	1.2	V
Output Current	I <sub>OUT</sub>	4	A
Switching Frequency	F <sub>sw</sub>	500	kHz

1) For different input, output spec, please refers to Ramp with small ESR cap, External Bootstrap Diode, Setting the Frequency and TYPICAL APPLICATION CRCUIT section on datasheet to choose proper values.

### FEATURES

- Up to 4A Output Current
- 40μA Quiescent Current
- 90mΩ /30mΩ High Side/ Low Side R<sub>DS(ON)</sub> for Internal Power MOSFETs
- Forced PWM or Auto PFM/PWM Mode Selectable
- Programmable Switching Frequency
- Power Good Indicator
- Cycle-by-Cycle Over Current Protection
- Short Circuit Protection with Hiccup Mode
- Thermal Shutdown
- Stable with Low ESR Ceramic Output Capacitors
- Programmable Soft-Start Time
- Available in QFN14 (2mmx3mm)Package

### APPLICATIONS

- Tablet PCs
- Solid State Drives
- Gaming
- Battery-operated Applications

All MPS parts are lead-free, halogen-free, and adhere to the RoHS directive. For MPS green status, please visit the MPS website under Quality Assurance.

"MPS" and "The Future of Analog IC Technology" are registered trademarks of Monolithic Power Systems, Inc.

## EV2326-D-00A EVALUATION BOARD



Board Number	MPS IC Number
EV2326-D-00A	MP2326GD

### Efficiency vs. Output Current

Auto PFM/PWM, V<sub>OUT</sub>=3.3V, L=4.7μH,  
DCR=19.5mΩ, F<sub>SW</sub>=500kHz

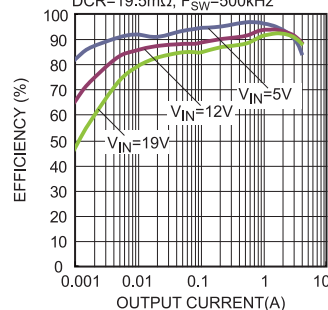

## EVALUATION BOARD SCHEMATIC

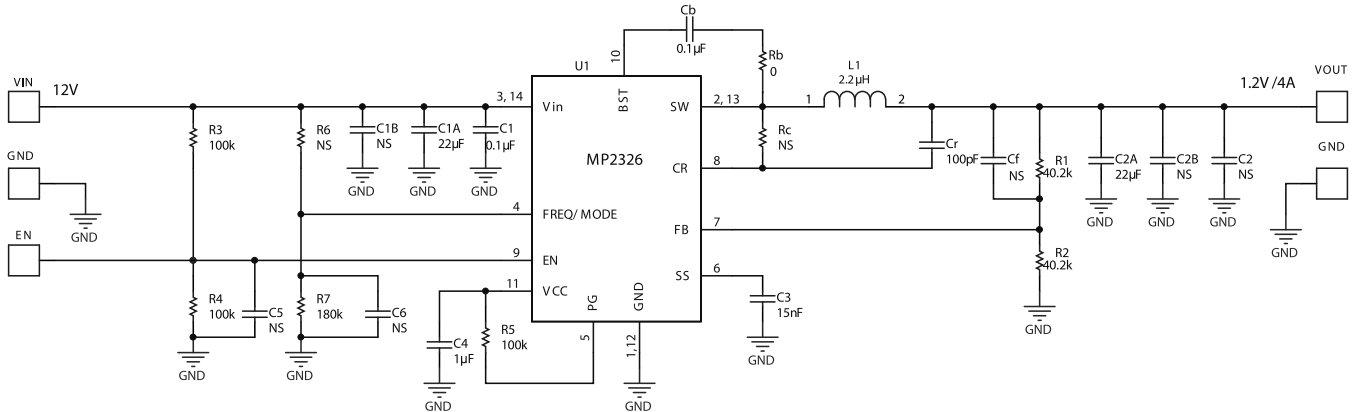
**Note:**

Use R6 and not use R7 to set part work at forced PWM Mode, Use R7 and not use R6 to set part work at Auto PFM/PWM Mode. Please see TYPICAL APPLICATION CRCUIT SECTION on DS to select R6.

## EV2326-D-00A BILL OF MATERIALS

Qty	Ref	Value	Description	Package	Manufacturer	Manufacturer P/N
2	R1, R2	40.2k	Film Res, 1%	0603	ROYAL	RL0603FR-0740K2L
3	R3, R4, R5	100k	Film Res, 1%	0603	ROYAL	RL0603FR-07100KL
0	R6, Rc	NS				
1	R7	180k	Film Res, 1%	0603	ROYAL	RL0603FR-07180KL
1	Rb	0Ω	Film Res, 1%	0603	Yageo	RC0603FR-070RL
1	C1	0.1µF	Ceramic Cap,25V,X7R	0603	Murata	GRM188R71E104KA01D
0	C2, C5, C6,Cf, C1B, C2B	NS				
1	Cb	0.1µF	Ceramic Cap, 16V, X7R	0603	Murata	GRM188R71C104KA01D
1	C3	15nF	Ceramic Cap, 50V, X7R	0603	TDK	C1608X7R1H153K
1	C4	1µF	Ceramic Cap,16V, X7R	0603	Murata	GRM188R71C105KA12D
1	Cr	100pF	Ceramic Cap, 50V, C0G	0603	Murata	GRM1885C1H101JA01D
1	C1A	22µF	Ceramic Cap,25V,X7R	1206	Murata	GRM31ER71E226KE15L
1	C2A	22µF	Ceramic Cap,10V,X7R	1206	Murata	GRM31CR71A226KE15L
1	L1	2.2µH	Inductor, DCR=11.4mΩ, Isat=13A	SMD	Würth	744311220
1	U1	MP2326GD	Synchronous Step-down Converter	QFN14(2mmX3mm)	MPS	MP2326GD

## EVB TEST RESULTS

Performance waveforms are tested on the evaluation board.

$V_{IN}=12V$ ,  $V_{OUT}=1.2V$ ,  $L=2.2\mu H$ ,  $T_A=25^\circ C$ , unless otherwise noted.

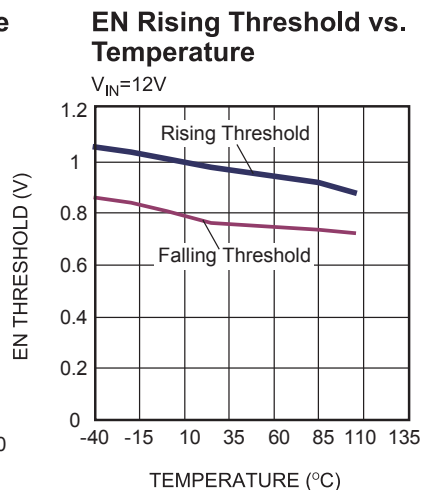
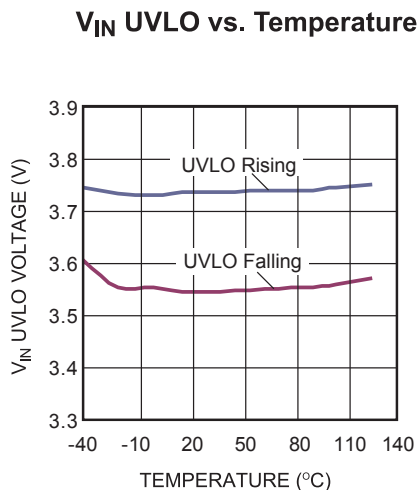
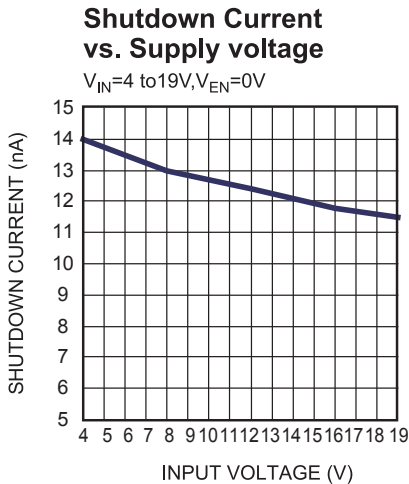
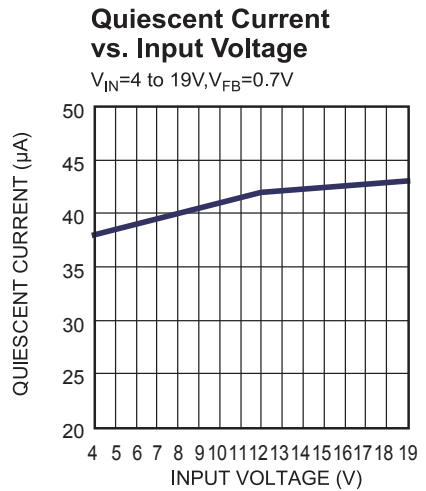
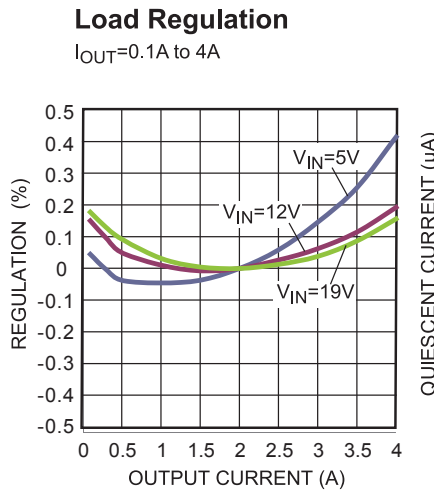
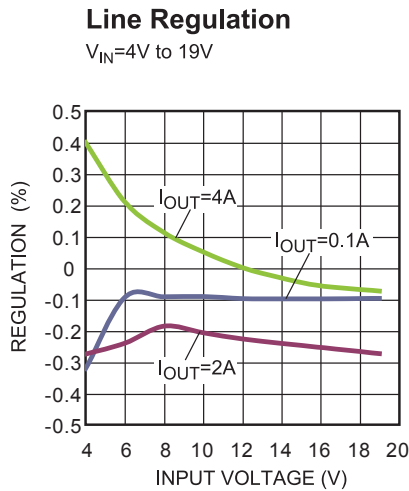
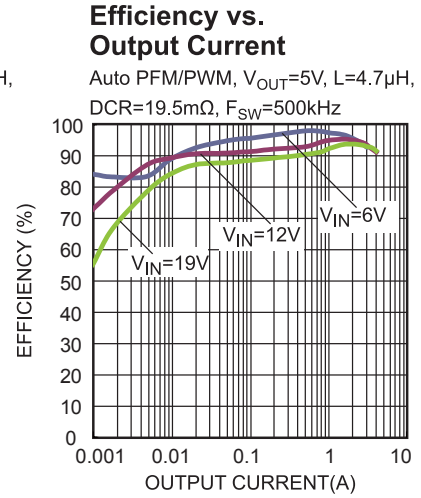
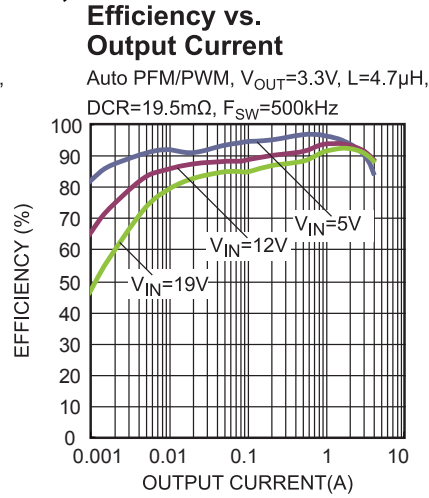
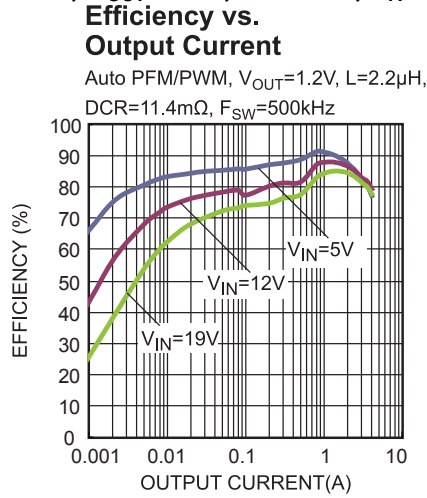

**EVB TEST RESULTS (continued)**

Performance waveforms are tested on the evaluation board.

$V_{IN}=12V$ ,  $V_{OUT}=1.2V$ ,  $L=2.2\mu H$ ,  $T_A=25^\circ C$ , unless otherwise noted.

**Max Frequency vs. Input Voltage**

Consider the minimum on time and minimum off time only

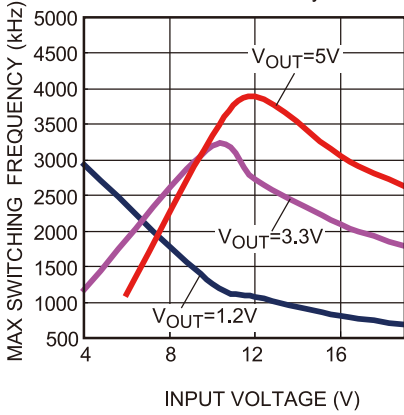

**Case Temperature Rise vs.  $I_{OUT}$**

$V_{OUT}=1.2V$ ,  $I_{OUT}=1A$  to  $4A$ , 4 Layers PCB, Size: 6.35cm X 6.35cm

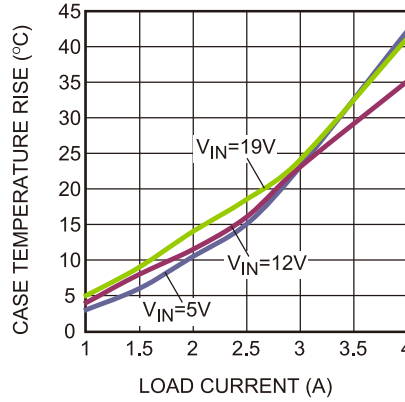

**Case Temperature Rise vs.  $I_{OUT}$**

$V_{OUT}=5V$ ,  $I_{OUT}=1A$  to  $4A$ , 4 Layers PCB, Size: 6.35cm X 6.35cm

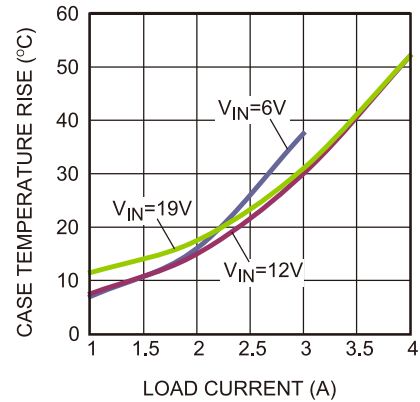

**EVB TEST RESULTS (continued)**

Performance waveforms are tested on the evaluation board.  
 $V_{IN}=12V$ ,  $V_{OUT}=1.2V$ ,  $L=2.2\mu H$ ,  $T_A=25^\circ C$ , unless otherwise noted.

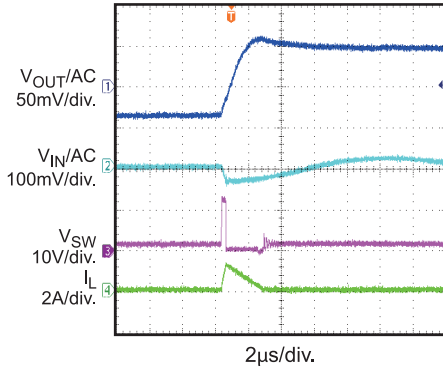
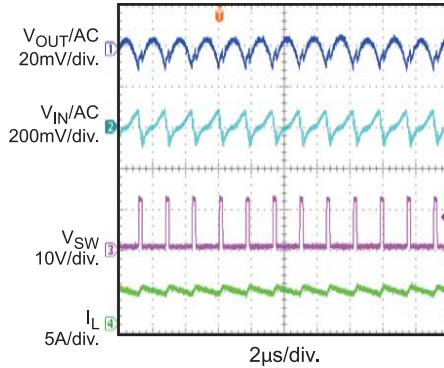
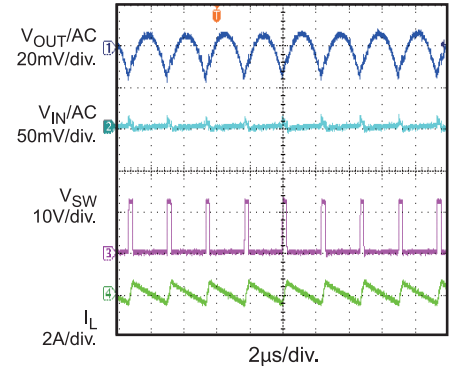
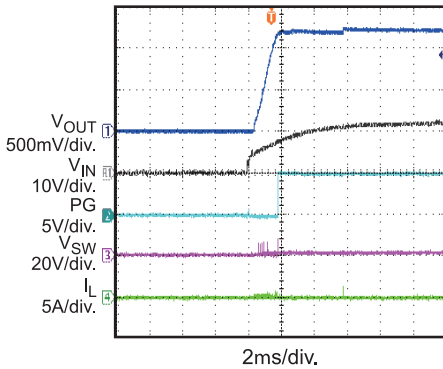
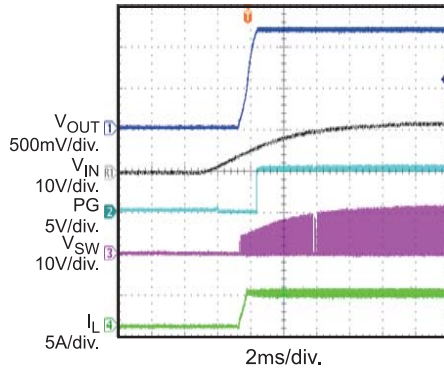
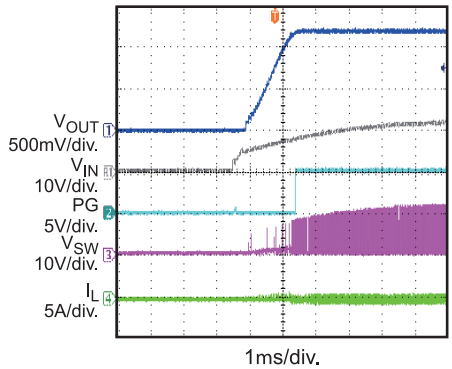
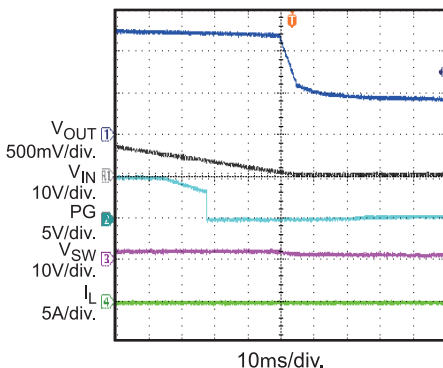
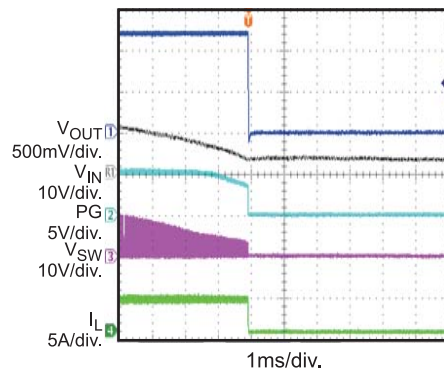
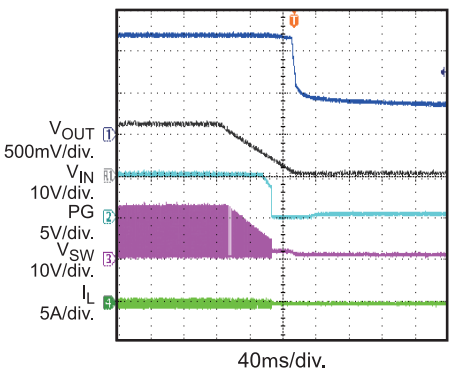
**Input/Output Ripple**  
 Auto PFM/PWM,  $I_{OUT}=0A$ 

**Input/Output Ripple**  
 $I_{OUT} = 4A$ 

**Input/Output Ripple**  
 Forced PWM,  $I_{OUT}=0A$ 

**Start-Up through  $V_{IN}$**   
 Auto PFM/PWM,  $I_{OUT}=0A$ 

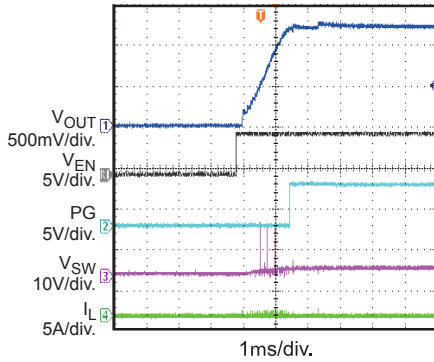
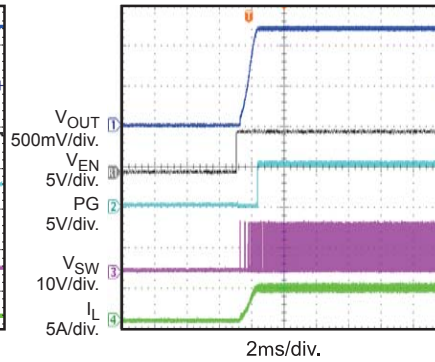
**Start-Up through  $V_{IN}$**   
 $I_{OUT} = 4A$ 

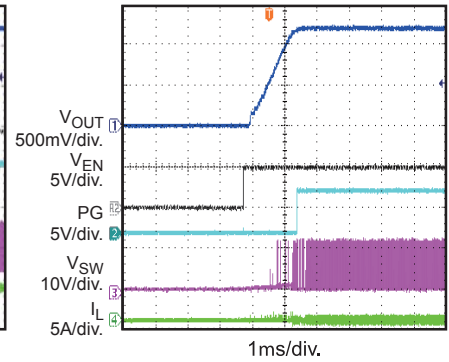
**Start-Up through  $V_{IN}$**   
 Forced PWM,  $I_{OUT}=0A$ 

**Shutdown through  $V_{IN}$**   
 Auto PFM/PWM,  $I_{OUT}=0A$ 

**Shutdown through  $V_{IN}$**   
 $I_{OUT} = 4A$ 

**Shutdown through  $V_{IN}$**   
 Forced PWM,  $I_{OUT}=0A$ 

## EVB TEST RESULTS (continued)

Performance waveforms are tested on the evaluation board.  
 $V_{IN}=12V$ ,  $V_{OUT}=1.2V$ ,  $L=2.2\mu H$ ,  $T_A=25^\circ C$ , unless otherwise noted.

**Start-Up through EN**

 Auto PFM/PWM,  $I_{OUT}=0A$ 

**Start-Up through EN**
 $I_{OUT} = 4A$ 

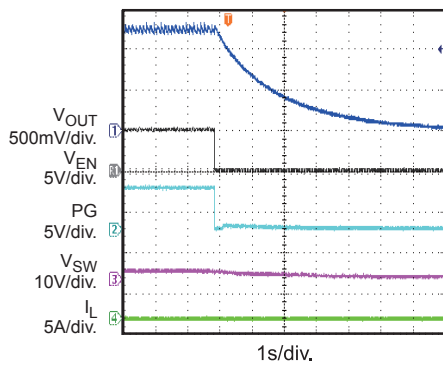
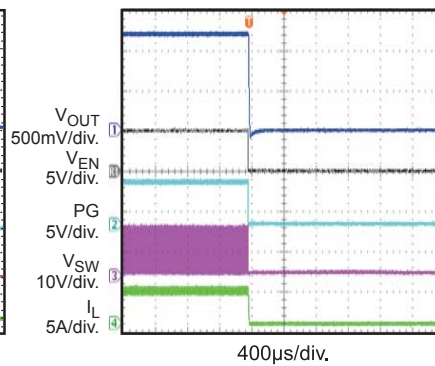
**Start-Up through EN**

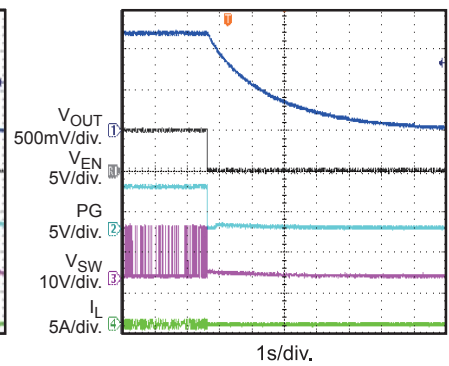
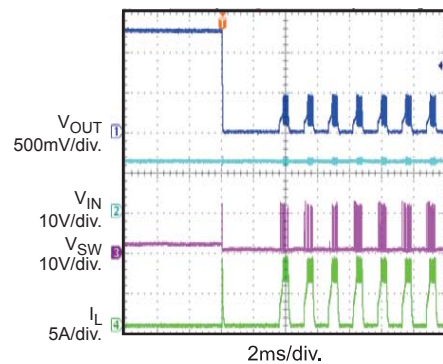
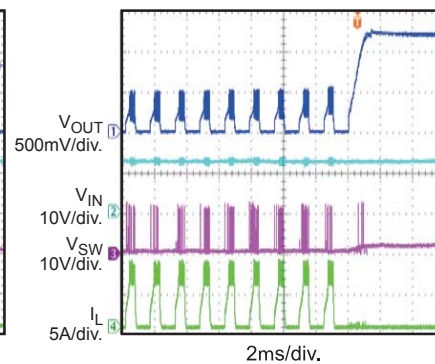
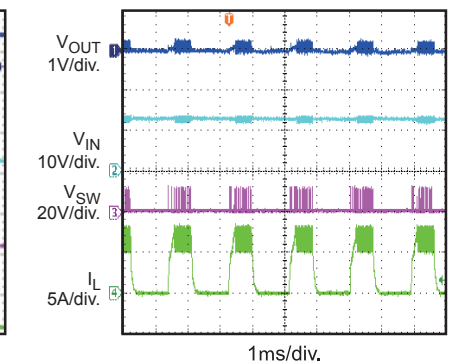
 Forced PWM,  $I_{OUT}=0A$ 

**Shutdown through EN**

 Auto PFM/PWM,  $I_{OUT}=0A$ 

**Shutdown through EN**
 $I_{OUT} = 4A$ 

**Shutdown through EN**

 Forced PWM,  $I_{OUT}=0A$ 

**Short-Circuit Entry**
 $I_{OUT}=0A$ 

**Short-Circuit Recovery**
 $I_{OUT} = 0A$ 

**Short-Circuit Steady State**
 $I_{OUT} = 0A$ 



**EVB TEST RESULTS (continued)**

Performance waveforms are tested on the evaluation board.

$V_{IN}=12V$ ,  $V_{OUT}=1.2V$ ,  $L=2.2\mu H$ ,  $T_A=25^\circ C$ , unless otherwise noted.

**Load Transient**

$I_{OUT}=2A$  to  $4A$ ,  $0.8A/\mu s$

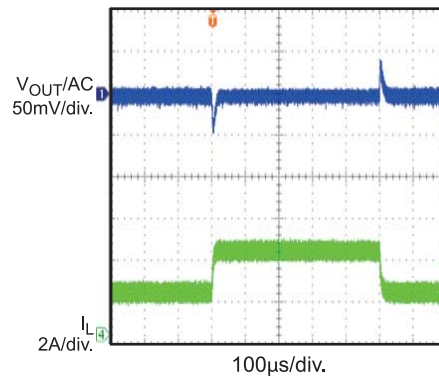

## PRINTED CIRCUIT BOARD LAYOUT

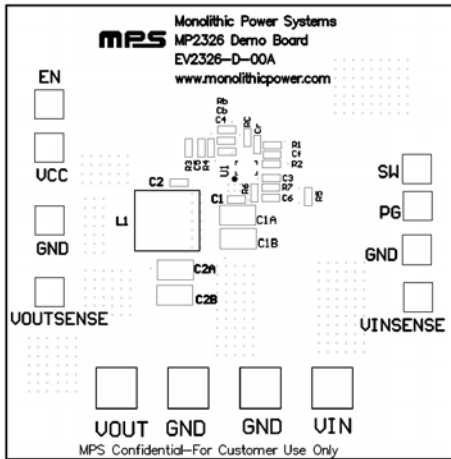

Figure 1—Top Silk Layer

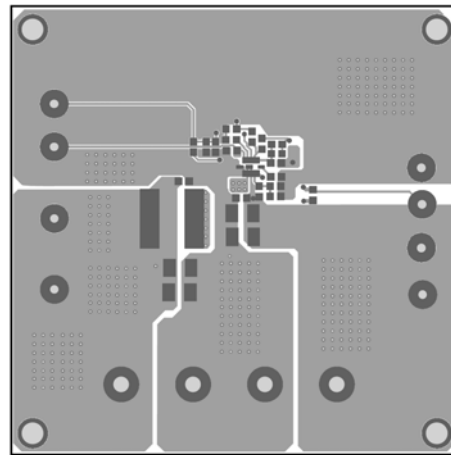

Figure 2—Top Layer

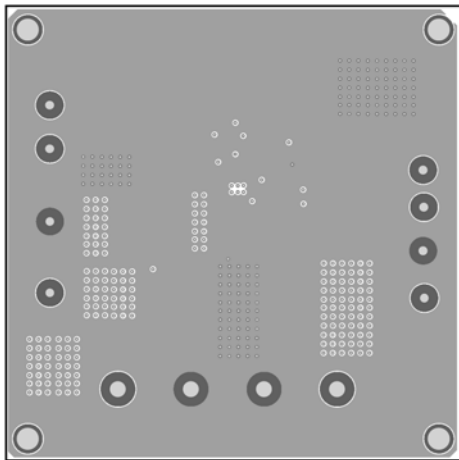

Figure 3—Inner 1 Layer

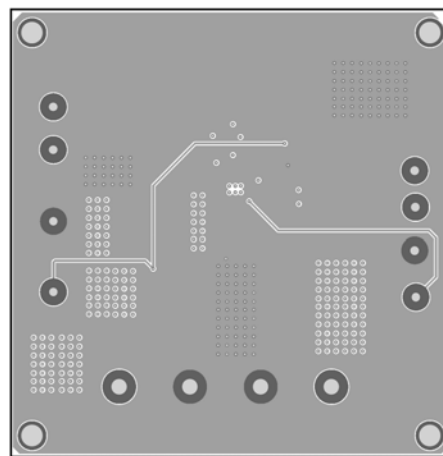

Figure 4—Inner 2 Layer

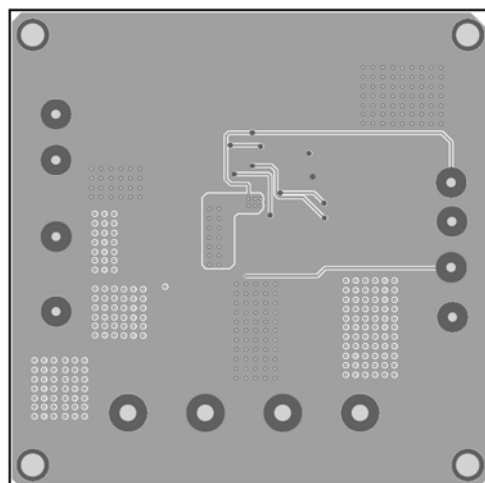

Figure 5—Bottom Layer



## QUICK START GUIDE

1. Connect the positive and negative terminals of the load to the VOUT and GND pins, respectively.
2. Preset the power supply output at 12V, and then turn off the power supply.
3. Connect the positive and negative terminals of the power supply output to the VIN and GND pins, respectively.
4. Turn the power supply on. The board will automatically start up.
5. To use the Enable function, apply a digital input to the EN pin. Drive EN higher than 1.6V to turn on the regulator or less than 0.4V to turn it off.

## LAYOUT RECOMMENDATION OF MP2326

Proper layout of the switching power supplies is very important, and sometimes critical for proper function. Poor layout design can result in poor line or load regulation and stability issues. Please follow these guidelines and take Page 8 as reference:

1. The high current paths (GND, IN and SW) should be placed very close to the device with short, direct and wide traces.
2. The input capacitor needs to be as close as possible to the IN and GND pins.
3. The Mode/Frequency circuit should be placed close to the part.
4. The external feedback resistors should be placed next to the FB pin.
5. Keep the switching node SW short and away from the feedback network.

In order to have better performances, it is better to use four layer boards. The inner 1 and 2 layers are Ground.

**NOTICE:** The information in this document is subject to change without notice. Please contact MPS for current specifications. Users should warrant and guarantee that third party Intellectual Property rights are not infringed upon when integrating MPS products into any application. MPS will not assume any legal responsibility for any said applications.