



The Future of Analog IC Technology®

EV2319-J-00A

18V/3A, 650KHz, Step Down Converter Evaluation Board

DESCRIPTION

The MP2319 is a fully-integrated high-frequency, synchronous rectified, step-down, switch-mode converter with internal power MOSFETs. Constant On-Time control operation provides very fast transient response and easy loop design as well as very tight output regulation.

The Evaluation Board can deliver a 3A continuous output current with excellent load and line regulation over a wide input supply range.

Full protection features include over-current protection and thermal shut down.

The MP2319 requires a minimum number of readily-available standard external components and is available in a space saving 8-pin TSOT23 package.

ELECTRICAL SPECIFICATION

Parameter	Symbol	Value	Units
Input Voltage	V_{IN}	4.5 – 18	V
Output Voltage	V_{OUT}	3.3	V
Output Current	I_{OUT}	3	A

FEATURES

- Wide 4.5V-to-18V Operating Input Range
- 3A Output Current
- 105mΩ/57mΩ Low- $R_{DS(ON)}$ Internal Power MOSFETs
- Output Adjustable from 0.8V
- EN Shutdown Output Discharge
- Internal Soft-Start
- High-Efficiency Synchronous-Mode Operation
- Fixed 650kHz Switching Frequency
- EN and Power Good for Power Sequencing
- Over-Current Protection and Hiccup
- Thermal Shutdown
- Auto Retry OVP Protection
- Available in a 8-pin TSOT-23 package

APPLICATIONS

- Security Cameras
- Portable Device, xDSL Device
- Digital Set-Top Boxes
- Flat-Panel Television and Monitors
- General Purposes

All MPS parts are lead-free and adhere to the RoHS directive. For MPS green status, please visit MPS website under Products, Quality Assurance page.

"MPS" and "The Future of Analog IC Technology" are registered trademarks of Monolithic Power Systems, Inc.

EV2319-J-00A EVALUATION BOARD



Board Number	MPS IC Number
EV2319-J-00A	MP2319GJ

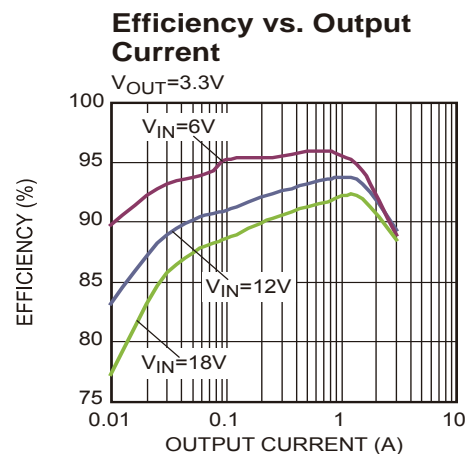

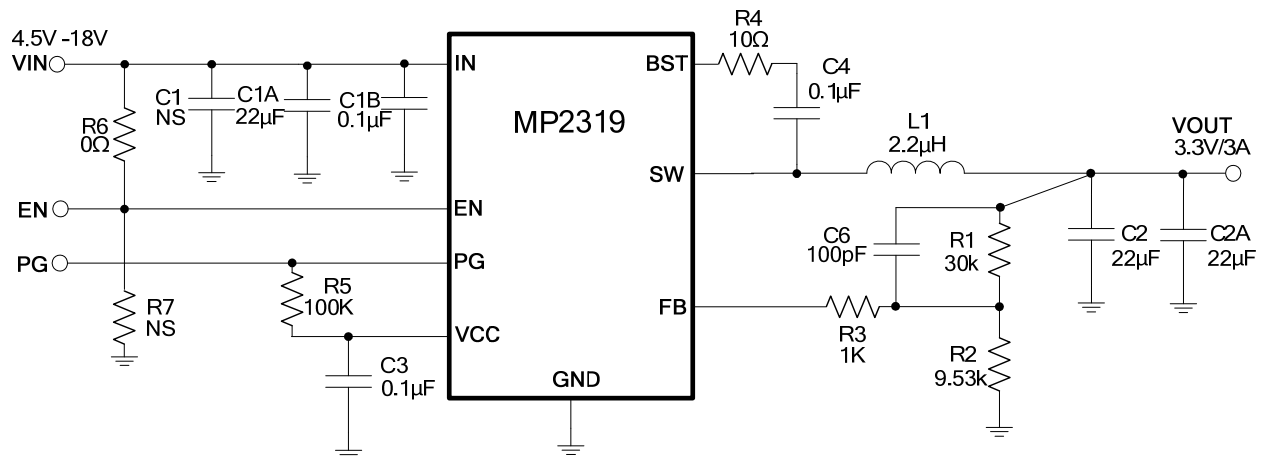
EVALUATION BOARD SCHEMATIC

EV2319-J-00A BILL OF MATERIALS

Qty	Ref	Value	Description	Package	Manufacturer	Manufacturer P/N
3	C1B,C3,C4	0.1μF	Ceramic Cap,25V,X7R	0603	Murata	GRM188R71E104KA01D
3	C2,C2A,C1A	22μF	Ceramic Cap,25V,X5R	1206	Murata	GRM31CR61E226KE15L
1	C6	100pF	Ceramic Cap,50V,C0G	0603	Murata	GRM1885C1H101JA01D
1	R1	30 kΩ	Film Res., 1%	0603	ROYAL	RL0603FR-0730KL
1	R2	9.53kΩ	Film Res., 1%	0603	ROYAL	RL0603FR-079K53L
1	R3	1kΩ	Film Res., 1%	0603	ROYAL	RL0603FR-071KL
1	R4	10 Ω	Film Res,1%	0603	ROYAL	RL0603FR-0710RL
1	R6	0 Ω	Film Res., 1%	0603	Yageo	RC0603FR-070RL
1	R5	100kΩ	Film Res., 1%	0603	ROYAL	RL0603FR-07100KL
0	R7	NS				
1	L1	2.2μH	DCR=11.4mΩ, IR=9A,Isat=13A		Würth	744 311 220
1	U1		Step-Down Converter	TSOT-23	MPS	MP2319GJ

EVB TEST RESULTS

$V_{IN} = 12V$, $V_{OUT} = 3.3V$, $L = 2.2\mu H$, $T_A = 25^\circ C$, unless otherwise noted.

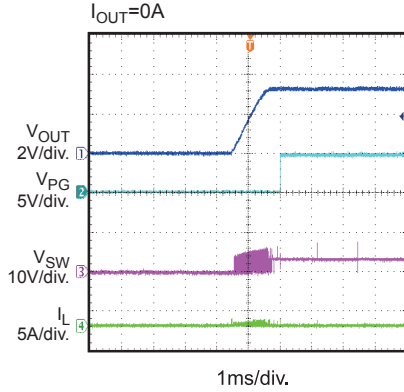
Start-Up through Input Voltage
 $I_{OUT} = 0A$



Start-Up through Input Voltage
 $I_{OUT} = 3A$

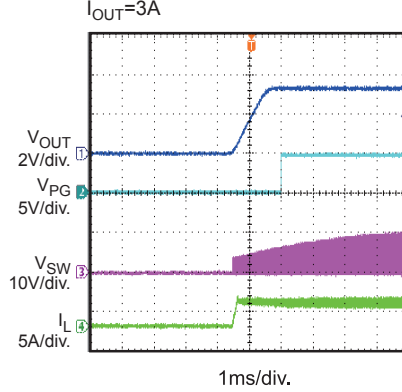

Shutdown through Input Voltage
 $I_{OUT} = 0A$

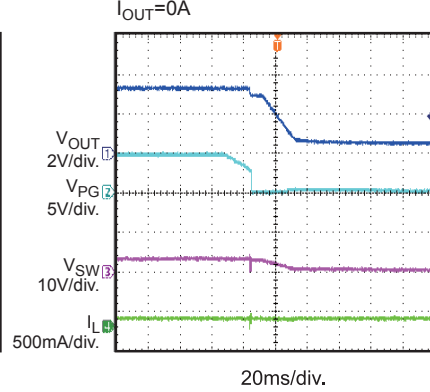

Shutdown through Input Voltage
 $I_{OUT} = 3V$

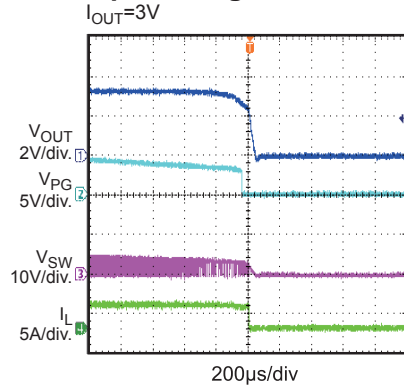

Start-Up through Enable
 $I_{OUT} = 0A$

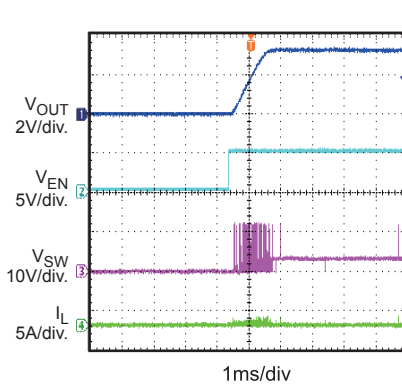

Start-Up through Enable
 $I_{OUT} = 3A$

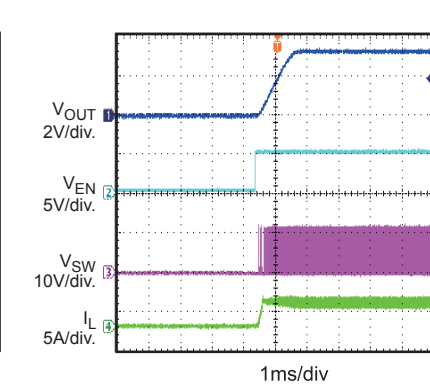

Shutdown through Enable
 $I_{OUT} = 0A$

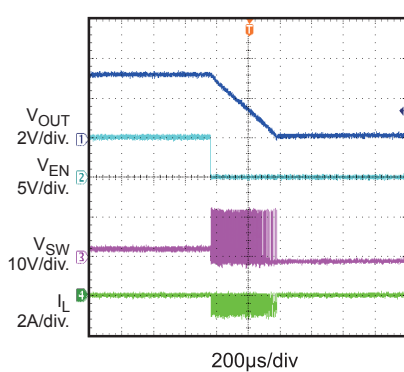

Shutdown through Enable
 $I_{OUT} = 3A$

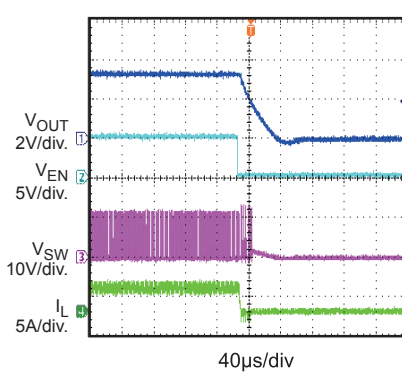

Input/Output Ripple
 $I_{OUT} = 0A$

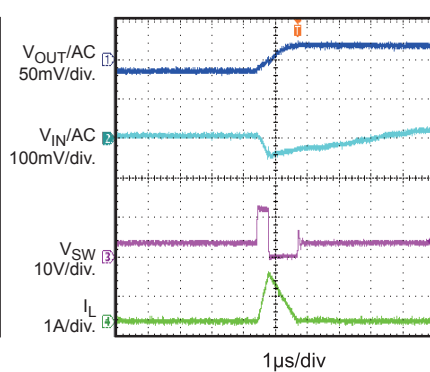

TYPICAL PERFORMANCE CHARACTERISTICS (continued)

$V_{IN} = 12V$, $V_{OUT} = 3.3V$, $L = 2.2\mu H$, $T_A = 25^\circ C$, unless otherwise noted.

Input/Output Ripple

$I_{OUT} = 3A$

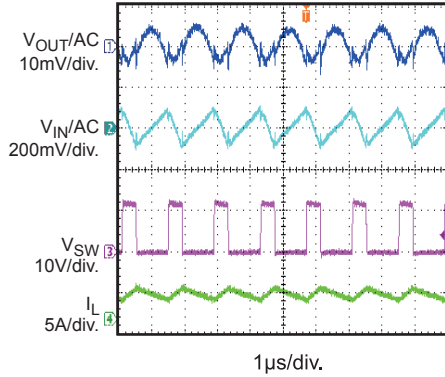

SCP Entry

$I_{OUT} = 0A$

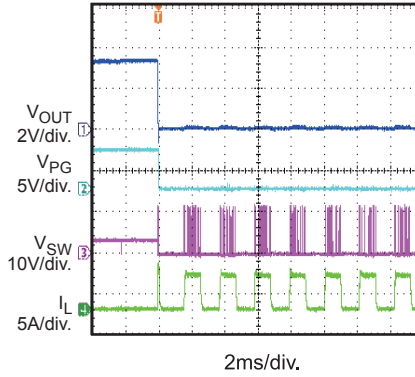

SCP Recovery

$I_{OUT} = 0A$

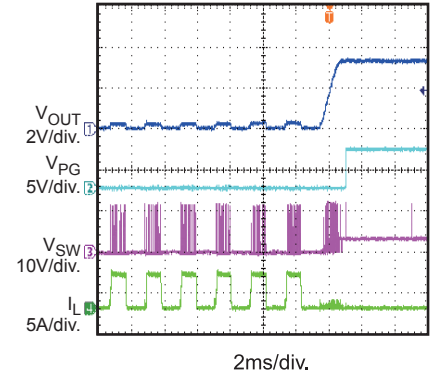

Load Transient Response

$I_{OUT} = 1.5A$ to $3A$

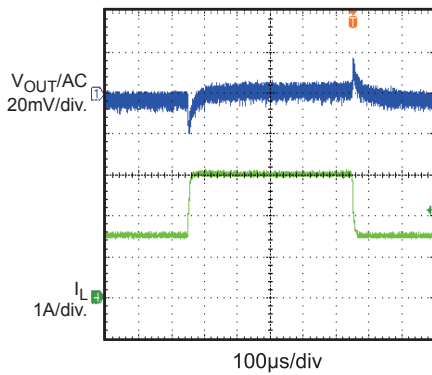

PRINTED CIRCUIT BOARD LAYOUT

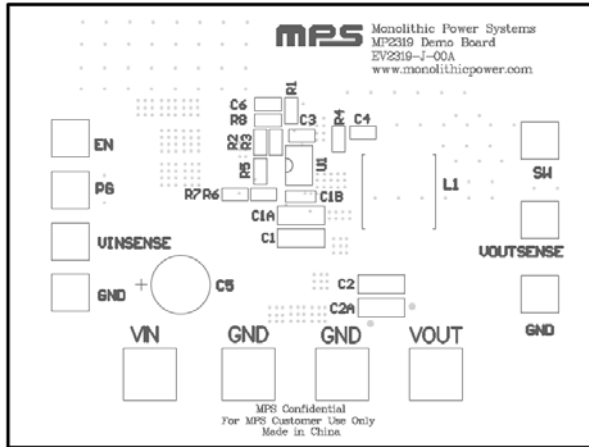

Figure 1—Top Silk Layer

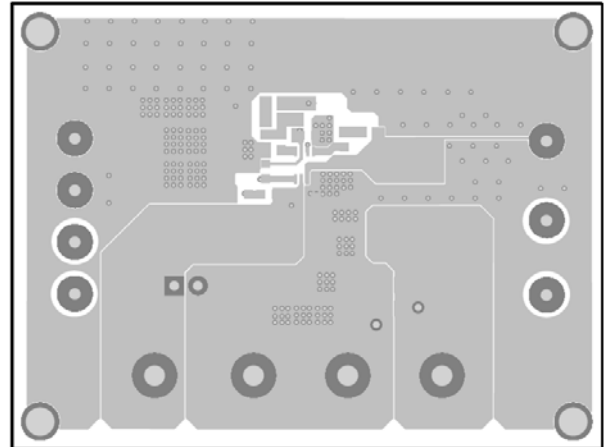

Figure 2—Top Layer

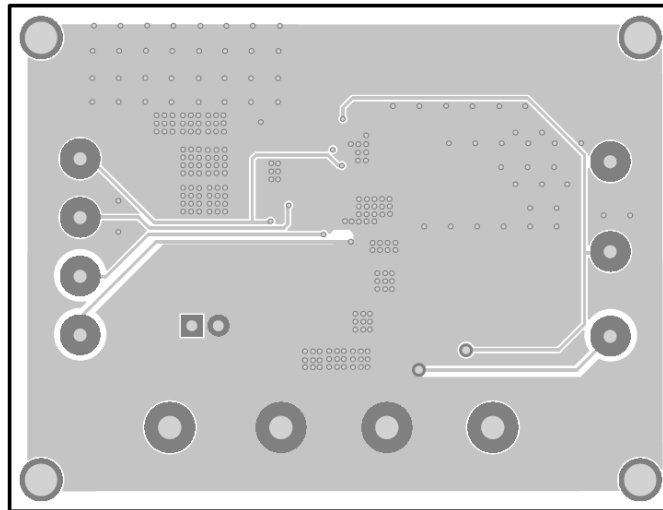

Figure 3—Bottom Layer

QUICK START GUIDE

1. Connect the positive and negative terminals of the load to the VOUT and GND pins, respectively.
2. Preset the power supply output between 4.5V and 18V, and then turn off the power supply.
3. Connect the positive and negative terminals of the power supply output to the VIN and GND pins, respectively.
4. Turn the power supply on. The board will automatically start up.

NOTICE: The information in this document is subject to change without notice. Please contact MPS for current specifications. Users should warrant and guarantee that third party Intellectual Property rights are not infringed upon when integrating MPS products into any application. MPS will not assume any legal responsibility for any said applications.