

### DESCRIPTION

The EV2314-J-00A demonstrates MPS's MP2314, a high-frequency, synchronous, rectified, step-down converter with built-in high-side and low-side power MOSFETs. The MP2314 offers a very compact solution to achieve a 2A continuous output current with excellent load and line regulation over a wide input supply range. The MP2314 has synchronous mode operation for higher efficiency over the output current load range.

Current-mode operation provides fast transient response and eases loop stabilization.

Full protection features includes over-current protection and thermal shutdown.

The MP2314 is available in a space-saving 8-pin TSOT23 package.

### ELECTRICAL SPECIFICATION

Parameter	Symbol	Value	Units
Input Voltage	$V_{IN}$	4.5 – 24	V
Output Voltage	$V_{OUT}$	5	V
Output Current	$I_{OUT}$	2	A

### FEATURES

- Wide 4.5V to 24V Operating Input Range
- 120mΩ/50mΩ Low  $R_{DS(ON)}$  Internal Power MOSFET
- Proprietary Switching-Loss-Reduction Technique
- High-Efficiency Synchronous Mode Operation
- Default 500kHz Switching Frequency
- Synchronizes from a 200kHz-to-2MHz External Clock
- AAM Power-Save Mode
- Internal Soft-Start
- OCP Protection and Hiccup
- Thermal Shutdown
- Output Adjustable from 0.8V
- Available in an 8-pin TSOT-23 Package

### APPLICATIONS

- Notebook System and I/O Power
- Digital Set-Top Boxes
- Flat-Panel Television and Monitors
- Distributed Power Systems

All MPS parts are lead-free and adhere to the RoHS directive. For MPS green status, please visit MPS website under Products, Quality Assurance page. "MPS" and "The Future of Analog IC Technology" are registered trademarks of Monolithic Power Systems, Inc.

### EV2314-J-00A EVALUATION BOARD

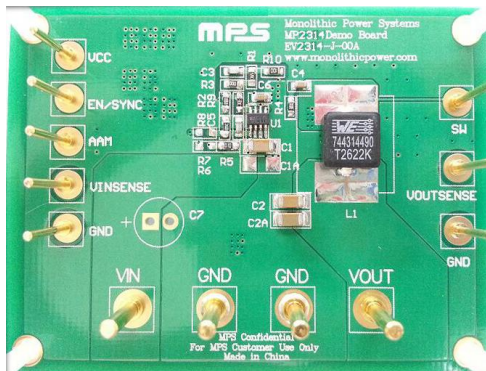

Board Number	MPS IC Number
EV2314-J-00A	MP2314GJ

### Efficiency

$V_{IN}=6V$  to 24V,  $V_{OUT}=5V$ ,  $R_8=75\Omega$

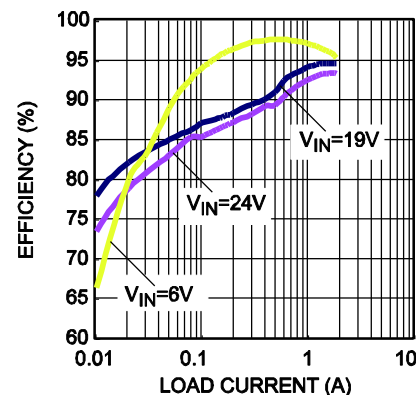

## EVALUATION BOARD SCHEMATIC

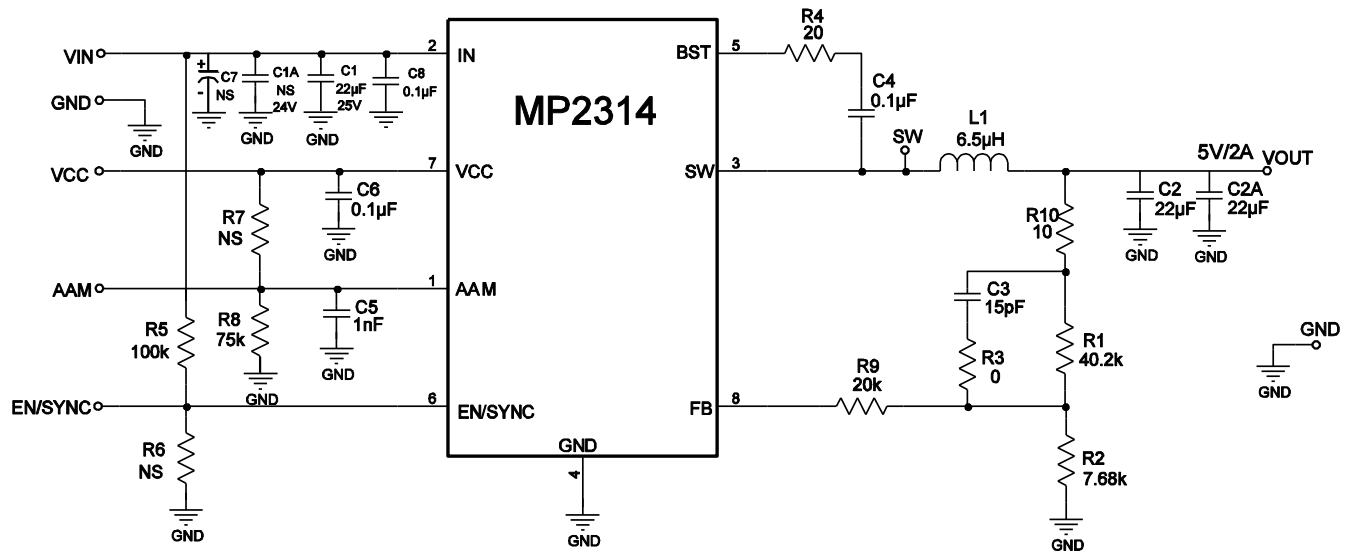

## EV2314-J-00A BILL OF MATERIALS

Qty	RefDes	Value	Description	Package	Manufacturer	Manufacturer P/N
1	C1	22µF	Ceramic Cap., 25V, 10%, X5R	1206	muRata	GRM31CR61E226KE15L
2	C1A, C7	NS		1206		
2	C2, C2A	22µF	Ceramic Cap., 10V, X7R	1206	muRata	GRM21BR60J226ME39L
1	C3	15pF	Ceramic Cap., 50V, C0G	0603	muRata	GRM1885C1H390JA01D
3	C4, C6, C8	0.1µF	Ceramic Cap., 16V, X7R	0603	muRata	GRM188R71C104KA01D
1	C5	1nF	Ceramic Cap., 50V, X7R	0603	muRata	GRM188R71H102KA01D
1	R1	40.2k	Thick Film Res., 1%	0603	Yageo	9C06031A4022FKHFT
1	R2	7.68k	Thick Film Res., 1%	0603	Yageo	
1	R3	0Ω	Thick Film Res., 1%	0603	Yageo	9C06031A0R00JLHFT
1	R4	20Ω	Thick Film Res., 5%	0603	Yageo	9C06031A20R0JLHFT
1	R5	100k	Thick Film Res., 1%	0603	Any	
0	R6, R7	NS				
1	R8	75k	Thick Film Res., 1%	0603	Any	
1	R9	20k	Thick Film Res., 1%	0603	Any	
1	R10	10Ω	Thick Film Res., 1%	0603	Yageo	9C06031A10R0FKHFT
1	L1	6.5µH	Inductor, DCR=22mΩ, Is=6A	SMD	Würth	744314650
1	U1	MP2314GJ	Synchronous Step-Down Convert	TSOT23-8	MPS	MP2314GJ

## EVB TEST RESULTS

Performance waveforms are tested on the evaluation board.

$V_{IN} = 12V$ ,  $V_{OUT} = 5V$ ,  $L = 6.5\mu H$ ,  $T_A = 25^\circ C$ , unless otherwise noted.

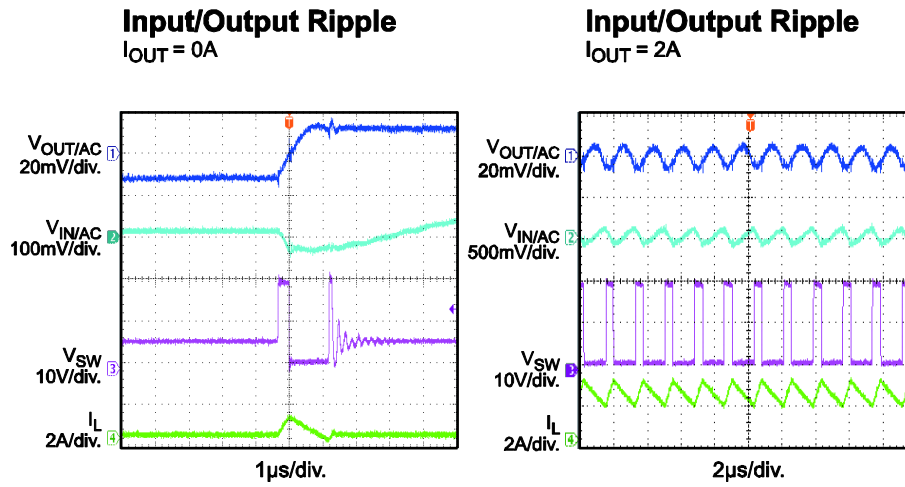

## PRINTED CIRCUIT BOARD LAYOUT

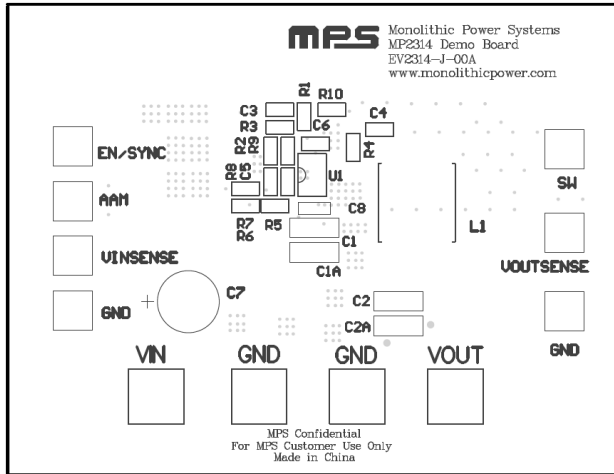

Figure 1—Top Silk Layer

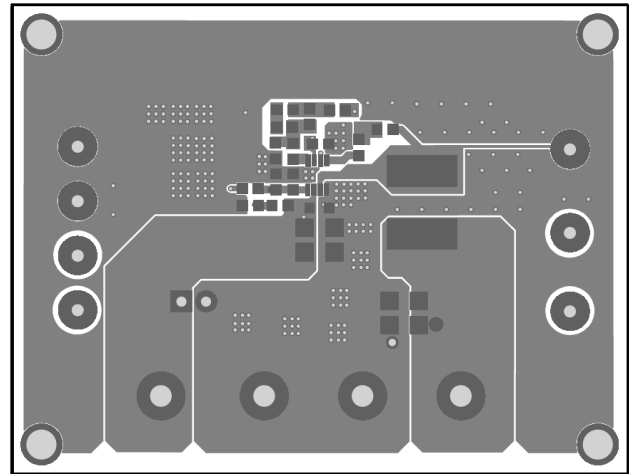

Figure 2—Top Layer

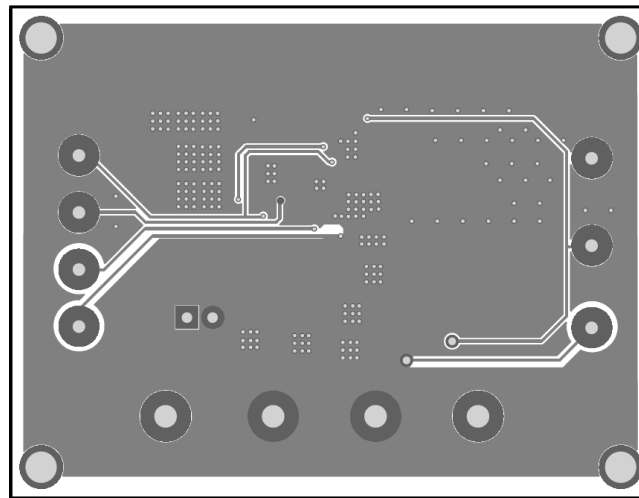

Figure 3—Bottom Layer

## QUICK START GUIDE

1. Connect the positive and negative terminals of the load to the VOUT and GND pins, respectively.
2. Preset the power supply output between 4.5V and 24V, and then turn off the power supply.
3. Connect the positive and negative terminals of the power supply output to the VIN and GND pins, respectively.
4. Turn the power supply on. The board will automatically start up.
5. To use the Enable function, apply a digital input to the EN/SYNC pin. Drive EN higher than 1.4V to turn on the regulator, or less than 1.25V to turn it off.
6. To use the external synchronous function to adjust the switching frequency, apply an external clock signal to EN/SYNC pin.

**NOTICE:** The information in this document is subject to change without notice. Please contact MPS for current specifications. Users should warrant and guarantee that third party Intellectual Property rights are not infringed upon when integrating MPS products into any application. MPS will not assume any legal responsibility for any said applications.