

DESCRIPTION

The EV2263-D-00A demonstrates MPS's MP2263, a high-frequency, synchronous, rectified, step-down converter with built-in high-side and low-side power MOSFETs. The MP2263 offers a compact solution to achieve a 3A continuous output current with excellent load and line regulation over a wide input- supply range. The MP2263 has synchronous mode operation for higher efficiency over the output current load range.

Current-mode operation provides fast transient response and eases loop stabilization.

Full protection features include over-current protection (OCP) and thermal shutdown (TSD).

The MP2263 is available in a QFN-15 package.

ELECTRICAL SPECIFICATION⁽¹⁾

Parameter	Symbol	Value	Units
Input Voltage	V _{IN}	12	V
Output Voltage	V _{OUT}	3.3	V
Output Current	I _{OUT}	3	A
Frequency	F _{SW}	500	kHz

Notes:

1) For different input /output voltage, inductor value, output capacitor value, and switching frequency may affect the selection of application circuit parameters.

FEATURES

- Wide 3.3V to 30V Operating Voltage Range
- 3A Continuous Output Current
- 1µA Low Shutdown Supply Current
- 12µA Sleep Mode Quiescent Current
- 90mΩ/38mΩ High Side/Low Side R_{DS(ON)} for Internal Power MOSFETs
- 350kHz to 2.5MHz Programmable Switching Frequency
- Power Good Output
- External Soft-Start
- 80ns Minimum On Time
- Selectable Forced PWM Mode and Auto PFM/PWM Mode
- Low Dropout Mode
- Hiccup Over Current Protection
- QFN-15 (2mmx3mm)

APPLICATIONS

- Battery Powered Systems
- Smart Home
- Wide Input Range Power Supply
- Standby Power Supply

All MPS parts are lead-free, halogen-free, and adhere to the RoHS directive. For MPS green status, please visit the MPS website under Quality Assurance. "MPS" and "The Future of Analog IC Technology" are registered trademarks of Monolithic Power Systems, Inc.

EV2263-D-00A EVALUATION BOARD



Board Number	MPS IC Number
EV2263-D-00A	MP2263GD

Efficiency vs. Load Current
V_{OUT}=3.3V, L=4.7µH

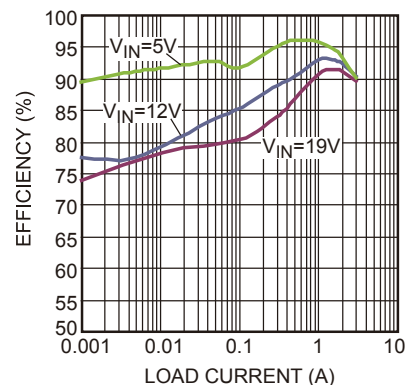

EVALUATION BOARD SCHEMATIC

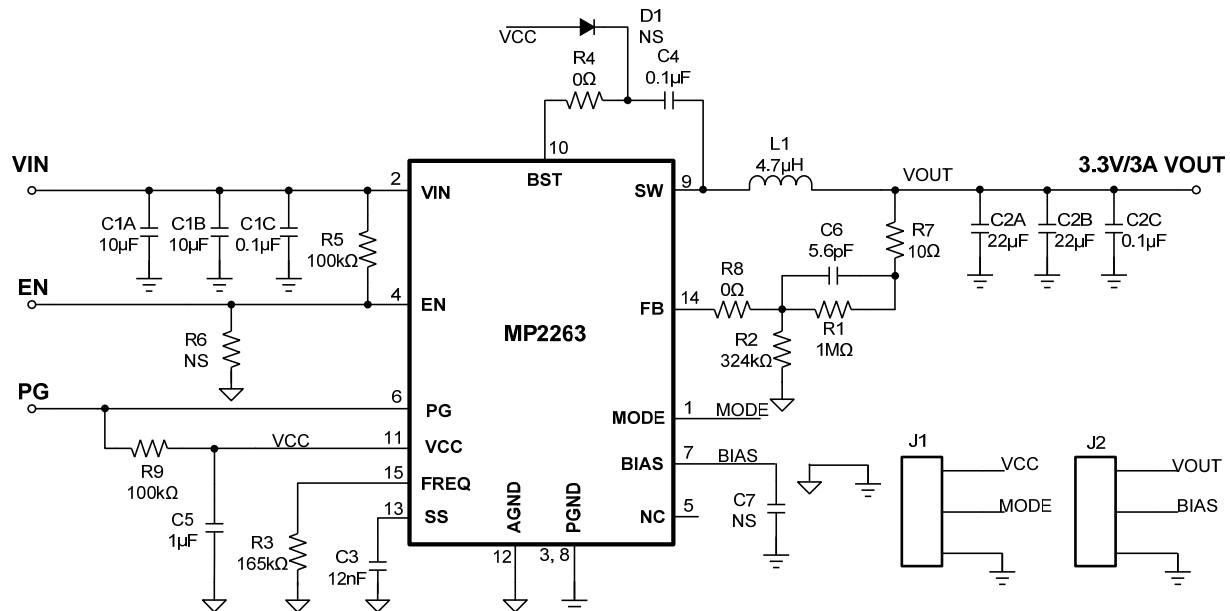

EV2263-D-00A BILL OF MATERIALS

Qty	Ref	Value	Description	Package	Manufacturer	Manufacturer P/N
2	C1A, C1B	10μF	Ceramic Cap., 50V, X5R	1206	muRata	GRM31CR61H106KA12L
1	C1C	0.1μF	Ceramic Cap., 50V, X7R	0603	muRata	GRM188R71H104KA93D
2	C2A, C2B	22μF	Ceramic Cap., 16V, X5R	1206	muRata	GRM31CR61C226ME15L
2	C2C, C4	0.1μF	Ceramic Cap., 16V, X7R	0603	muRata	GRM188R71C104KA01D
1	C3	12nF	Ceramic Cap., 50V, X7R	0603	muRata	GRM188R71H123KA01D
1	C5	1μF	Ceramic Cap., 16V, X7R	0603	muRata	GRM188R71C105KA12D
1	C6	5.6pF	Ceramic Cap., 50V, C0G	0603	muRata	GRM1885C1H5R6DZ01D
0	C7, D1	NS				
1	R1	1M	Thick Film Res., 1%	0603	Yageo	RC0603FR-071ML
1	R2	324k	Thick Film Res., 1%	0603	Yageo	RC0603FR-07324KL
1	R3	165k	Thick Film Res., 1%	0603	Yageo	RC0603FR-07165KL
2	R4, R8	0Ω	Thick Film Res., 1%	0603	Yageo	RC0603FR-070RL
2	R5, R9	100k	Thick Film Res., 1%	0603	Yageo	RC0603FR-07100KL
0	R6	NS				
1	R7	10Ω	Thick Film Res., 1%	0603	Yageo	RC0603FR-0710RL
2	J1, J2	Jumper	Jumper	SIP-3	Any	
1	L1	4.7μH	Inductor, DCR=19.5mΩ, Is=7A	SMD	Würth	744311470
1	U1	MP2263 GD	Synchronous Step-Down Converter	QFN-15(2mmx3mm)	MPS	MP2263GD

EVB TEST RESULTS

Performance waveforms are tested on the evaluation board.

$V_{IN} = 12V$, $V_{OUT} = 3.3V$, $L = 4.7\mu H$, $F_{SW} = 500kHz$, $T_A = 25^\circ C$, BIAS and MODE are connected to GND, unless otherwise noted.

Input/Output Ripple

$I_{OUT} = 0A$

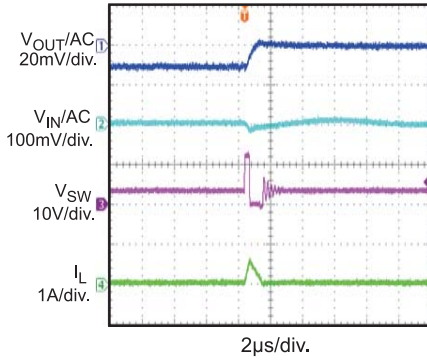

Input/Output Ripple

$I_{OUT} = 3A$

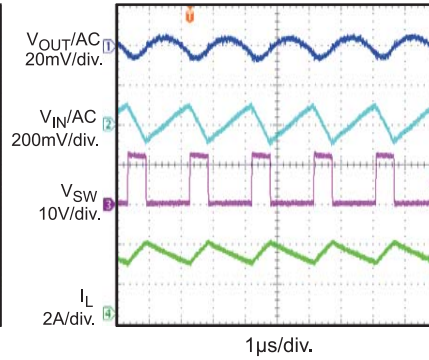

Start-Up through Input Voltage

$I_{OUT} = 0A$

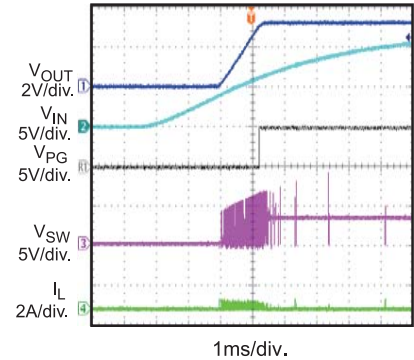

Start-Up through Input Voltage

$I_{OUT} = 3A$

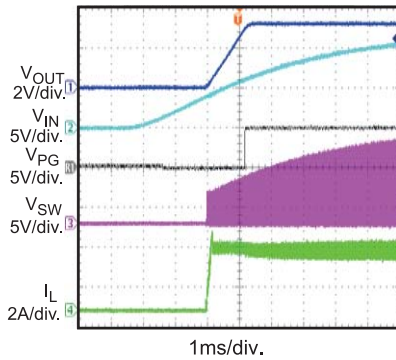

Shutdown through Input Voltage

$I_{OUT} = 0A$

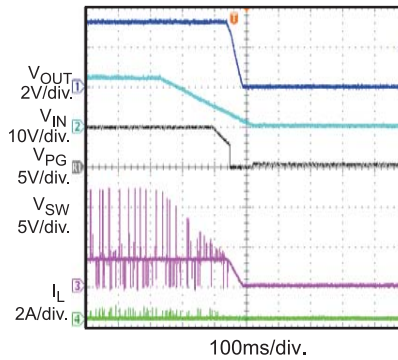

Shutdown through Input Voltage

$I_{OUT} = 3A$

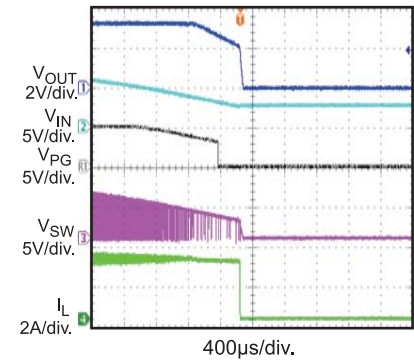

Start-Up through EN

$I_{OUT} = 0A$

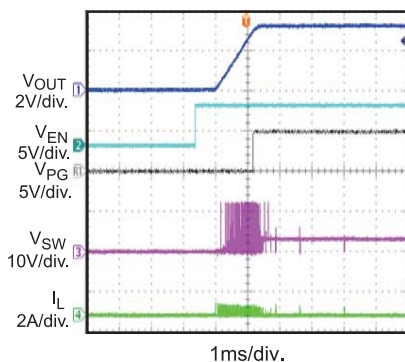

Start-Up through EN

$I_{OUT} = 3A$

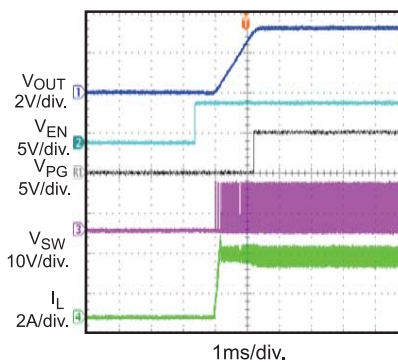

Shutdown through EN

$I_{OUT} = 0A$

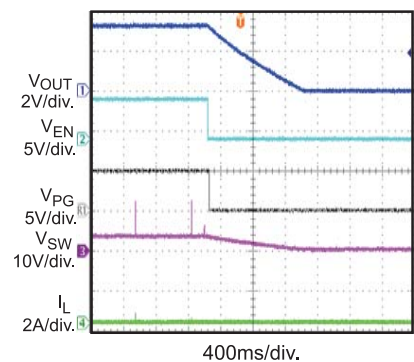

EVB TEST RESULTS *(continued)*

Performance waveforms are tested on the evaluation board.

$V_{IN} = 12V$, $V_{OUT} = 3.3V$, $L=4.7\mu H$, $F_{SW}=500kHz$, $T_A = 25^\circ C$, BIAS and MODE are connected to GND, unless otherwise noted.

Shutdown through EN

$I_{OUT} = 3A$

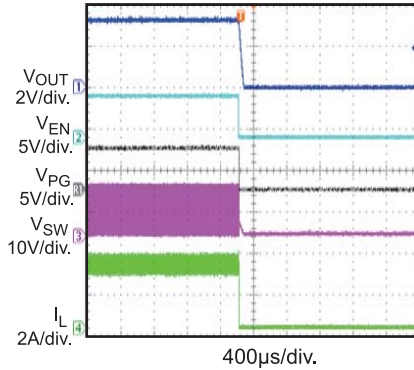

Short Circuit Protection Entry

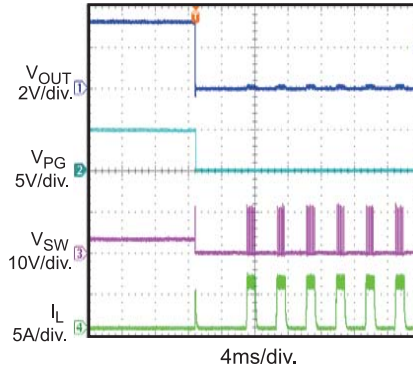

Short Circuit Protection Recovery

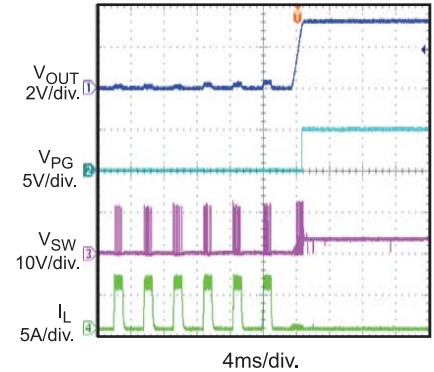

Load Transient Response

$I_{OUT} = 1.5A$ to $3A$

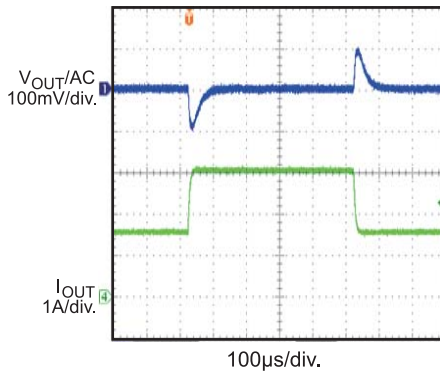

PRINTED CIRCUIT BOARD LAYOUT

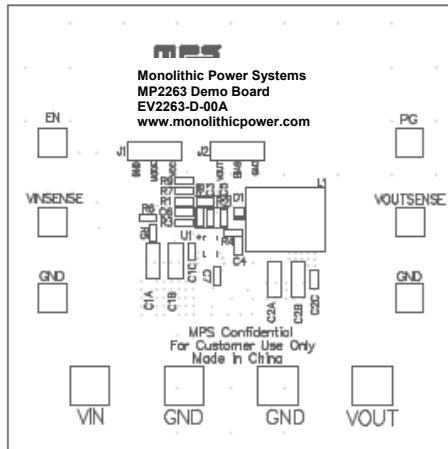

Figure 1—Top Silk Layer

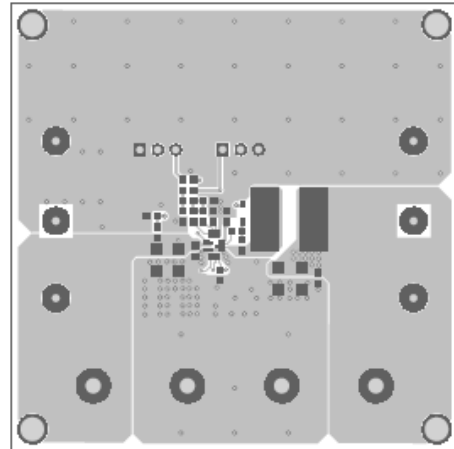

Figure 2—Top Layer

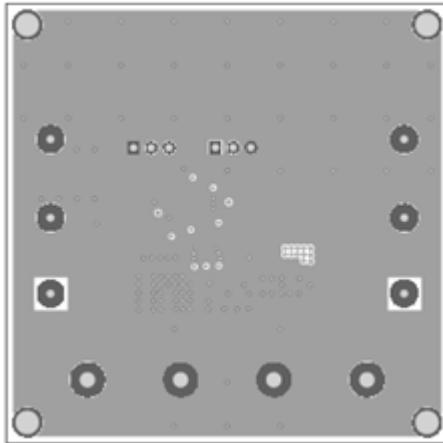

Figure 3—Middle1 Layer

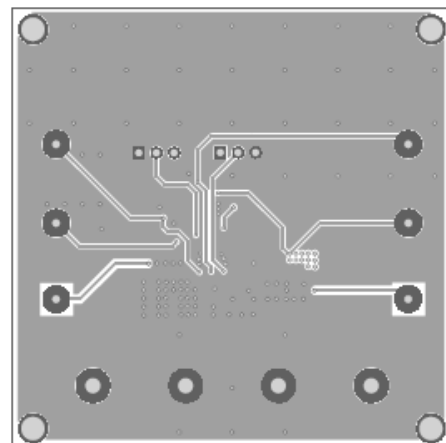

Figure 4—Middle2 Layer

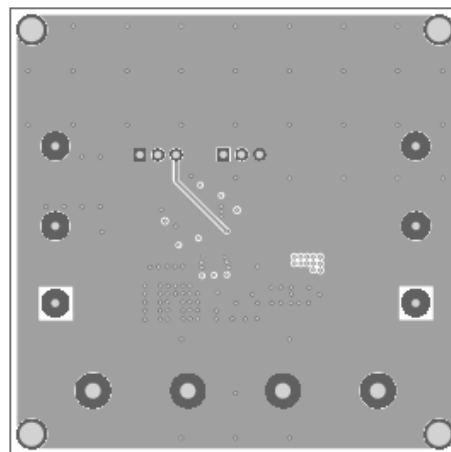

Figure 5—Bottom Layer

QUICK START GUIDE

1. Connect the positive and negative terminals of the load to the VOUT and GND pins, respectively.
2. Preset the power supply output 12V, and then turn off the power supply.
3. Connect the positive and negative terminals of the power supply output to the VIN and GND pins, respectively.
4. Turn the power supply on. The board will automatically start up.
5. To use the Enable function, apply a digital input to the EN pin. Drive EN higher than 1.05V to turn on the regulator, or less than 0.93V to turn it off.

NOTICE: The information in this document is subject to change without notice. Please contact MPS for current specifications. Users should warrant and guarantee that third party Intellectual Property rights are not infringed upon when integrating MPS products into any application. MPS will not assume any legal responsibility for any said applications.